



EGLO
my light | my style



2022/23

INTERIOR LIGHTING

WOHNRAUMLEUCHTEN
LUMINAIRES INTÉRIEURS



Dear business partners and faithful friends of EGLO,

We are proud to present our new luminaire highlights, inspired by the latest trends and styles of the 2022/23 season. Sustainability, with a focus on protecting the planet and its resources, is still very much in demand. Protecting the environment while at the same time creating a future for many generations to come has become part of a global commitment. The call for freedom, humility, a return to nature, and security is louder than ever, especially in these times of crisis. It is more important to ever to be able to feel secure and at ease in your own home. Our Boho, Wabi Sabi and New Nordic Style fittings are designed to meet this need. All these home decorating trends combine simplicity, warm colours and harmony. The calm, minimalist styles of the season, with their occasional rough edges, are enhanced by rich metallic tones in brass and bronze, creating small eye-catching highlights in your living room. Be inspired and explore this year's world of EGLO lighting trends.

I hope you enjoy browsing our new main catalogue.

Geschätzte Geschäftspartner*innen, treue EGLO Freund*innen,

Freuen sie sich auf unsere Leuchten-Highlights, angelehnt an die aktuellen Trends und Styles der Saison 2022/23. Nach wie vor sind Trends im Sinne der Nachhaltigkeit gefragt, diese bauen auf dem Schutz unseres Planeten und seiner Ressourcen auf. Es ist Teil einer globalen Verpflichtung geworden, die Umwelt zu schützen und gleichzeitig eine Zukunft für viele kommende Generationen zu schaffen. Gerade in den aktuellen Krisenzeiten ist der Ruf nach Freiheit, Demut und Natürlichkeit sowie Sicherheit lauter denn je. Umso wichtiger ist es, sich in seinen eigenen 4 Wänden geborgen und zu Hause zu fühlen. Mit Einrichtungen im Boho, Wabi Sabi oder New Nordic Style wird diesem Bedürfnis Rechnung getragen. All diese Wohntrends verbinden Einfachheit, warme Farbwelten und Harmonie miteinander. Die ruhigen und minimalistischen, manchmal auch unvollkommenen Styles der Saison, werden mit wertigen Metalltönen in Messing und Bronze abgerundet und kreieren kleine Eyecatcher im Wohnraum. Lassen Sie sich inspirieren und tauchen Sie ein in die Welt der EGLO Leuchten-Trends des Jahres.

Ich wünsche Ihnen viel Freude beim Durchschauen des neuen Hauptkatalogs.

Chers partenaires, chers amis d'EGLO,

Découvrez nos produits phares inspirés des tendances et styles actuels de la saison 2022/23. Cette fois encore, les tendances recherchées sont associées au développement durable, car elles favorisent la protection de notre planète et de ses ressources. Dans le monde entier, on s'est fixé le devoir de protéger l'environnement tout en créant un avenir pour les générations futures. En raison des périodes de crise que nous traversons actuellement, nous recherchons plus que jamais la liberté, l'humilité, la nature et la sécurité. Il est donc d'autant plus important de se sentir à l'aise et bien à l'abri chez soi. Un aménagement dans le style Boho, Wabi Sabi ou New Nordic permet de répondre à ce besoin. Tous ces styles allient simplicité et harmonie à un univers de couleurs chaleureuses. Les styles paisibles et minimalistes, voire imparfaits de cette saison sont complétés par des tons métalliques de qualité en laiton et en bronze pour attirer tous les regards. Laissez-vous inspirer et plongez dans le monde des tendances d'éclairage EGLO de l'année.

Je vous souhaite beaucoup de plaisir à consulter le nouveau catalogue.

Mag. René Tiefenbacher
CEO EGLO Group

CONTENT

INHALT
CONTENU



EGLO CONNECT

P.010 - 097



EGLO ACCESS

P.098 - 113



LIGHTING FAMILIES

FABRIC LUMINAIRES
STOFFLEUCHTEN
LUMINAIRES À TEXTIL

P.114 - 191



LIGHTING FAMILIES

WOOD LUMINAIRES
HOLZLEUCHTEN
LUMINAIRES À BOIS

P.192 - 211



LIGHTING FAMILIES

STANDARD LUMINAIRES
STANDARD LEUCHTEN
LUMINAIRES STANDARD

P.212 - 315



LIGHTING FAMILIES

GLASS CHANDELIERS
LEUCHTENFAMILIEN
FAMILIES DE LUMINAIRES

P.316 - 325



HANGING & PENDANT LUMINAIRES

HÄNGE- & PENDELLEUCHTEN
LUMINAIRES SUSPENSIONS

P.326 - 447



WALL & CEILING LUMINAIRES

WAND- & DECKENLEUCHTEN
APPLIQUES & PLAFONNIERS

P.448 - 595



BATH & MIRROR LUMINAIRES

BAD- & SPIEGELLEUCHTEN
LUMINAIRES DE BAIN & MIROIR

P.596 - 655



SPOTS & TRACK LUMINAIRES

SPOTS- & SCHIENENLEUCHTEN
SPOTS & LUMINAIRES SUR RAIL

P.656 - 749



CLIP & PLUG LUMINAIRES

KLEMM- & STECKERLEUCHTEN
LUMINAIRES À PINCE & SUR PRISE

P.750 - 755



TABLE & FLOOR LUMINAIRES

TISCH- & STEHLEUCHTEN
LUMINAIRES DE TABLE & LAMPADAIRES

P.756 - 797



OFFICE TABLE & FLOOR LUMINAIRES

OFFICE TISCH- & STEHLEUCHTEN
LUMINAIRES DE TABLE & LAMPADAIRES À BUREAU

P.798 - 831



CHILDREN LUMINAIRES

KINDERLEUCHTEN
LUMINAIRES POUR ENFANTS

P.832 - 837



KITCHEN & FUNCTION LUMINAIRES

KÜCHEN- & FUNKTIONSLEUCHTEN
LUMINAIRES FONCTIONNELS & DE CUISINE

P.838 - 843



ACCESSORIES

ZUBEHÖR
ACCESSOIRES

P.844 - 847



INDEX & LEGEND

INDEX & ERKLÄRUNG
INDEX & LÉGENDE

P.848 - 872



EGLO TREND HIGHLIGHTS

2022/23



The EGLO design team has once again drawn on current mega-trends as a source of inspiration for the 2022/23 season. The new EGLO products' use of shape and colour, choice of materials, and overall aesthetic harmonise perfectly with both contemporary and future living trends. Minimalism and the increasingly popular use of materials and colours such as brass and earth tones have had a particularly strong influence on this season's luminaire designs.

Auf Basis der Megatrends hat sich das Design-Team von EGLO auch für die Saison 2022/23 inspirieren lassen. Mit ihrer Formsprache, Farbgebung sowie den verwendeten Materialien fügen sich die EGLO Neuheiten in die aktuellen wie auch zukünftigen Wohntrends ein. Der Trend des Minimalismus sowie die Verwendung von Materialien und Farben wie Messing und Erdtöne haben auf die aktuellen Leuchten-Designs besonderen Einfluss genommen.

Sur la base des mégatendances, l'équipe de conception EGLO a également été inspirée pour la saison 2022/23. Avec leur langage visuel, leur palette de couleurs et les matériaux utilisés, les innovations EGLO s'intègrent dans les tendances de la vie d'aujourd'hui et de demain. La tendance au minimalisme et l'utilisation de matériaux et de couleurs tels que le laiton et les tons de terre ont eu une influence particulière sur les conceptions actuelles de nos luminaires.

Minimalism - The art of less, the conscious reduction of shapes and colours to the bare essentials, is reflected in our luminaires. Clear and simple shapes and plain colours combine to create a calm atmosphere, in keeping with the maxim "less is more". Warm grey tones and timber elements give the room a welcoming touch, adding atmospheric highlights and offering a harmonious stage for your entire living space to work its magic without any distractions.

Minimalismus - Der bewusste Verzicht und die Kunst, Form und Farbe auf ein Minimum zu reduzieren, spiegelt sich in unseren Leuchten wider. Frei nach dem Prinzip „Weniger ist mehr“ sorgen klare und einfache Formen sowie schlichte Farben für eine ruhige Atmosphäre. Für die nötige Gemütlichkeit setzen warme Grautöne oder Holzelemente stimmungsvolle Akzente und bieten eine harmonische Bühne, um den gesamten Raum ganz ohne Ablenkung für sich wirken zu lassen.

Le minimalisme - Nos lampes reflètent un renoncement volontaire et l'art de réduire au minimum formes et couleurs. Selon le principe « faire plus avec moins », des formes claires et simples et des couleurs unies créent une atmosphère paisible. Pour le confort, des tons gris chauds ou des éléments en bois mettent en place une ambiance agréable et un décor harmonieux pour vous permettre de travailler dans une pièce sans aucune distraction.



ONEDA





MANZANARES

Brass - Brass so popular back in the 50s and 60s, is currently enjoying a new wave of popularity. Skilfully paired with contrasting materials, the gleaming metallic hues of brass bring a touch of luxury to living spaces without appearing old-fashioned. We have incorporated the high-quality material into our new luminaire models and combined it with diverse other materials to create captivating modern designs that can be integrated into a variety of interiors, from urban to classical to minimalist.

Messing - Der bereits in den 50er und 60er Jahren so populäre Messingtrend erfreut sich aktuell an neuer Beliebtheit. Gekonnt kombiniert und kontrastreich in Szene gesetzt, bringt Messing mit seinem strahlenden Metallton einen Hauch von Luxus in die Wohnräume, ohne altmodisch zu wirken. Das hochwertige Material haben wir in unsere neuen Leuchten-Modelle einfließen lassen und in Kombination mit verschiedenen Materialien charmante und moderne Designs geschaffen, die sich in unterschiedliche Einrichtungen von urban über klassisch bis hin zu minimalistisch integrieren lassen.

Le laiton - La tendance du laiton, déjà si populaire dans les années 50 et 60, est actuellement à nouveau au goût du jour. Habilement combiné et mis en scène avec de riches contrastes, le laiton avec sa teinte métallique brillante apporte une touche de luxe aux espaces de vie sans paraître démodé. Nous avons incorporé ce matériau de haute qualité dans nos nouveaux modèles de luminaires et, en combinaison avec divers matériaux, avons créé des designs charmants et modernes qui peuvent être intégrés à des aménagements différents, qu'ils soient notamment urbains, classiques ou encore minimalistes.

Warm earth tones - The very popular back-to-nature trend has also brought about a significant shift in the field of design. More and more people have been embracing a return to nature in recent years and the associated use of natural materials has also left its mark on the world of colour, heralding the rise of brown as the new black. The colour brown in all its many facets can be beautifully paired with almost any other colour and, thanks to its diverse earthy tones, not only lends our living spaces a touch of naturalness, but also conveys a sense of warmth and comfort. Combining this year's popular colour trend with wood and brass elements helps accentuate its distinctive appeal.

Warme Erdtöne - Der starke Trend hin zu mehr Natürlichkeit hat auch im Design einen bedeutsamen Wandel bewirkt. Die in den letzten Jahren deutlich an Bedeutung gewonnene Verbundenheit zur Natur und die damit einhergehende Verwendung von natürlichen Materialien hat auch die Farbwelt geprägt und lässt Braun als das neue Schwarz triumphieren. Braun in all seinen Facetten lässt sich hervorragend kombinieren und verleiht unseren Wohnräumen durch seine vielfältigen Erdtöne nicht nur einen Hauch von Natürlichkeit, sondern vermittelt Gemütlichkeit und Behaglichkeit gleichermaßen. Die Kombination mit Holz oder Messing verleiht der neuen Trendfarbe ihre besonderen Akzente.

Des tons chauds de terre - La forte tendance vers un caractère plus naturel a également entraîné un changement significatif dans notre conception. Le lien avec la nature, qui a grandement gagné en importance ces dernières années, et l'utilisation associée de matériaux naturels ont également façonné l'univers des couleurs : c'est ainsi que le brun a détrôné le noir. Le brun sous toutes ses facettes peut être parfaitement combiné et, avec ses divers tons de terre, non seulement donner à nos salons une touche naturelle, mais aussi procurer confort et bien-être dans le même temps. La combinaison de cette nouvelle couleur tendance avec le bois ou le laiton lui confère ses accents si particuliers.



VALDIOLA

Look out for this Logo!

Achten Sie auf das Logo!

Soyez attentif au logo !

What is a forest?

A peaceful oasis, the green lungs of the world, and an adventure playground for children of all ages!

The Forest Stewardship Council® (FSC®) is a global, not-for-profit organisation dedicated to the promotion of responsible forest management worldwide. The FSC® defines standards for responsible forest management in accordance with established principles that are developed and supported by stakeholders from the environmental, social and economic spheres. For more information, please see www.fsc.org.

Was ist Wald für uns?

Eine Oase der Ruhe, die Lunge der Welt oder ein Abenteuerspielplatz für große und kleine Kinder!

Das Forest Stewardship Council® (FSC®) ist eine globale, gemeinnützige Organisation, mit dem Zweck verantwortungsvolle Waldbewirtschaftung weltweit zu fördern. FSC® definiert Standards für eine verantwortungsvolle Waldbewirtschaftung nach festgelegten Prinzipien, die von Interessenvertretern aus den Bereichen Umwelt, Soziales und Wirtschaft entwickelt und getragen werden. Für weitere Informationen besuchen Sie www.fsc.org.

Que représente la forêt pour nous ?

Une oasis de calme, les poumons du monde ou un terrain de jeu d'aventure pour les enfants de tous âges !

Le Forest Stewardship Council® (FSC®) est une organisation internationale à but non lucratif dont le but est de promouvoir une gestion forestière responsable dans le monde entier. Le FSC® définit des normes de gestion forestière responsable selon des principes établis qui sont développés et soutenus par les parties prenantes des secteurs environnemental, social et économique. Pour plus d'informations, veuillez consulter www.fsc.org.

Look out for FSC® -certified products!
Achten Sie auf FSC® -zertifizierte Produkte!
Soyez attentif aux produits certifiés FSC® !



The mark of
responsible forestry

DIGITAL CATALOGUE

This year, we are also making the main catalogue in front of you available online, including lots of extra information and additional features. In addition to search and filter functions, the online catalogue includes extensive product photos, videos and additional information, complementing the paper edition wonderfully. Take a look at <https://catalogue.eglo.com>

In diesem Jahr präsentieren wir den vor Ihnen liegenden Hauptkatalog wieder als Online-Katalog mit vielen Zusatzinformationen und zusätzlichen Features. Neben Such- und Filterfunktionen bietet der Online-Katalog mit reichhaltigen Produktabbildungen, Videos und zusätzlichen Informationen einen erheblichen Mehrwert zur gebundenen Ausgabe. Klicken Sie sich rein unter <https://catalogue.eglo.com>

Cette année, nous présentons à nouveau une version en ligne du catalogue général. Cette version contient de nombreuses informations et fonctionnalités complémentaires. Outre les fonctionnalités de recherche et de filtrage, le catalogue en ligne propose de nombreuses illustrations de produits, des vidéos et des informations complémentaires : une valeur ajoutée considérable par rapport à la version papier. Cliquez ici pour le découvrir : <https://catalogue.eglo.com>



99795

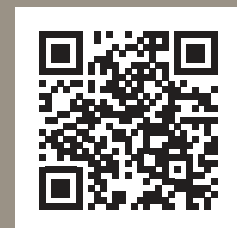

connect.2





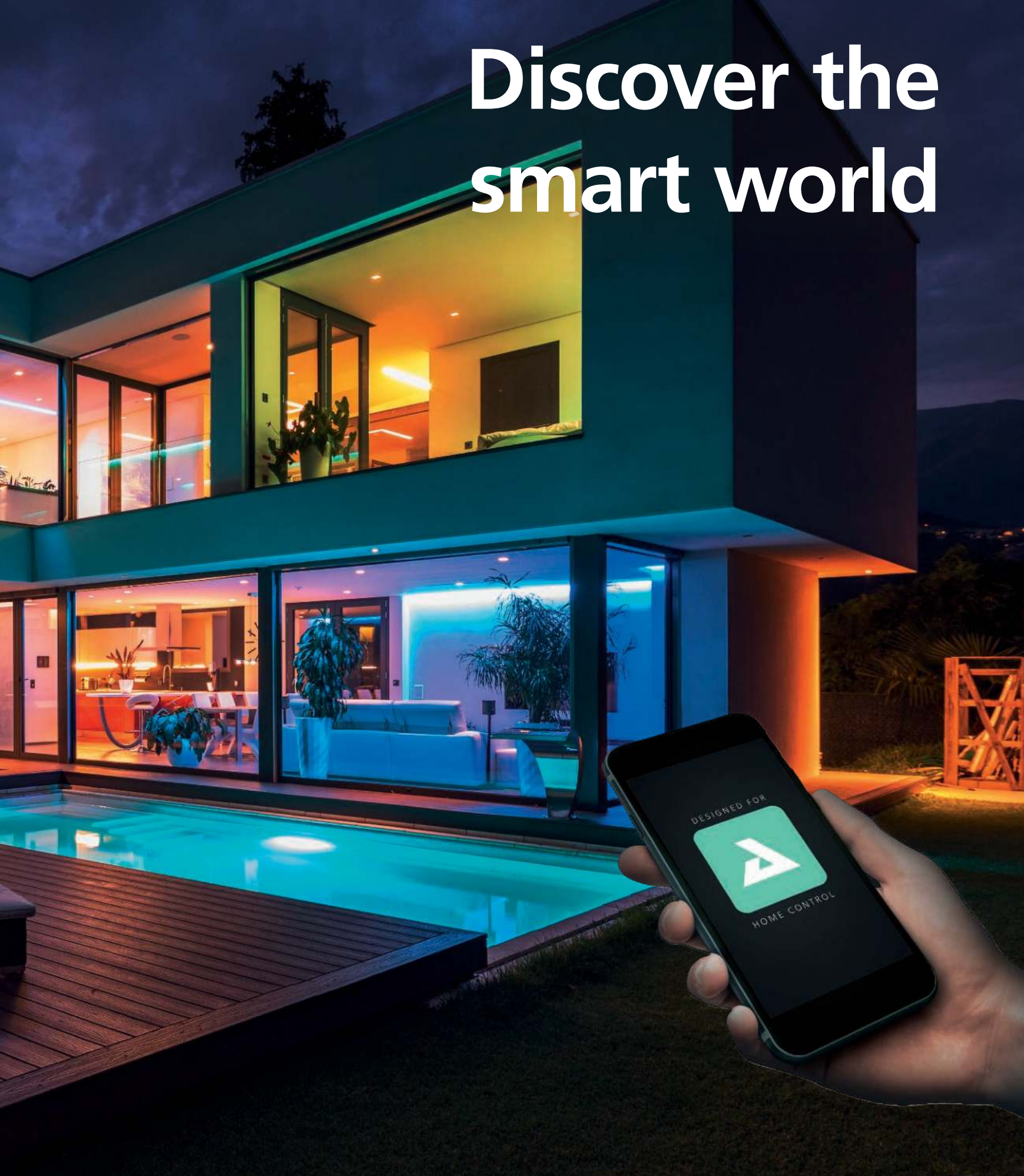



































 **zigbee**  **Bluetooth®**

Discover the smart world



OVERVIEW

EGLO CONNECT.Z

							
CONNECT-Z SENSOR p. 21	CONNECT Z p. 21	ANCHORENA-Z p. 22-23	SALVILANAS-Z p. 24-25	LOBINERO-Z p. 26	ZILLERIO-Z p. 26	ANDABAIA-Z p. 27	TELIBELA-Z p. 28-29
							
TOLLOS-Z p. 30	ROMAO-Z p. 30-31	MONTEMORELOS-Z p. 32-33	TOTARI-Z p. 33	GENOVESE-Z p. 33	PARRAPOS-Z p. 34-35	PARANDAY-Z p. 36-37	CALAGRANO-Z p. 37
							
PADROGIANO-Z p. 38-40	VALDELAGRANO-Z p. 42	SIMOLARIS-Z p. 42-43	MARGHERA-Z p. 44-45	CAMINALES-Z p. 46	SALICETO-Z p. 47	LOMALTAS-Z p. 48	TABIANO-Z p. 49
							
JUAREZA-Z p. 49	FRAIOLI-Z p. 50-51	TOTARI-Z p. 52-53	LANCIANO-Z p. 54	CAPASSO-Z p. 55	SILERAS-Z p. 55	SAVATARILA-Z p. 56-57	SALITERAS-Z p. 57
							
TURCONA-Z p. 58, 62-63	HERRORA-Z p. 60	SALOBRENA-Z p. 64-67	FUEVA-Z p. 68-79	ROVITO-Z p. 80-83	LED STRIPE-Z p. 84-85	LM_LED_E27 p. 86-97	LM_LED_GU10 p. 87
							
LM_LED_E14 p. 87							



This product is available in different colors and shapes./ Dieser Artikel ist in unterschiedlichen Farben und Formen verfügbar.
Cet article est disponible en différentes couleurs et formes.



connect.z combines two control technologies in one system

connect.z vereint zwei Steuerungstechnologien in einem System

connect.z réunit deux technologies de commande au sein d'un même système



ZigBee is far and away the most widely used standard in the smart home world.

ZigBee ist der am weitesten verbreitete Standard in der Smart Home Welt.

ZigBee est le protocole le plus répandu au monde dans le domaine du Smart Home.

ADVANTAGES :

- › Mesh network
- › Direct connection with Amazon Echo and Google Home
- › Compatible with products from different manufacturers
- › High level of security
- › Easy setup
- › Energy efficient

VORTEILE:

- › Mesh-Netzwerk
- › Direkte Verbindung mit Amazon Echo und Google Home
- › Herstellerübergreifend kompatibel
- › Hohe Sicherheit
- › Einfache Einrichtung
- › Energieeffizient

AVANTAGES:

- › Réseau maillé
- › Connexion directe à Amazon Echo et Google Home
- › Compatible indépendamment du fabricant
- › Sécurité élevée
- › Installation facile
- › Économe en énergie

connect.2



Bluetooth is an established standard in the digital world.
Bluetooth ist ein etablierter Standard in der digitalen Welt.
Bluetooth est un standard de communication reconnu dans le monde numérique.

ADVANTAGES:

- › Local & secure network
- › Protocol is mainly audio (low debit)
- › Mesh network: Elements are receivers and senders
- › Easy setup
- › Usable offline
- › Energy efficient

VORTEILE:

- › Lokales & sicheres Netzwerk Protokoll hauptsächlich Audio (Low Debit)
- › Mesh-Netzwerk: Elemente sind Empfänger und Sender
- › Einfache Einrichtung
- › Offline nutzbar
- › Energieeffizient

AVANTAGES:

- › Réseau local et sûr
- › Protocole essentiellement audio (bas débit)
- › Réseau maillé : les éléments sont l'émetteur et le récepteur
- › Installation facile
- › Utilisable hors-ligne
- › Économe en énergie

Light up your world!

Bringen Sie Licht in Ihren Alltag!
Illuminez votre quotidien !



connect.z offers a wide range of lamps and lighting equipment. Select products from the following options according to your needs:
connect.z bietet ein großes Sortiment an Leuchten und Leuchtmitteln. Wählen Sie die Produkte ganz nach Ihren Bedürfnissen aus folgenden Varianten:
connect.z propose une large gamme de luminaires et d'ampoules. Sélectionnez les produits en fonction de vos besoins parmi les variantes suivantes :

Warm White

Neutral White

Tunable White

Individual light from 50,000 white tones.
Individuelles Licht aus 50.000 Weißtönen.
Luminaire individuel à 50 000 tons de blanc.

TW + RGB Colors

Diverse lighting selection from 50,000 white tones and 16 million colours.
Vielseitige Lichtauswahl aus 50.000 Weißtönen und 16 Mio. Farben.
Sélection étendue de luminaires à 50 000 tons de blanc et 16 millions de couleurs.

Enjoy relaxing moments!
Genießen Sie entspannte Momente!
Profitez de moments de détente !

Stay focussed & efficient!
Bleiben Sie konzentriert & leistungsfähig!
Restez concentré(e) et performant(e) !

Start the day fresh every morning!
Starten Sie jeden Morgen frisch in den Tag!
Commencez la journée du bon pied !

Create the perfect atmosphere!
Kreieren Sie Ihr perfektes Ambiente!
Créez votre ambiance parfaite !



Enjoy many useful convenience features: Es erwarten Sie viele nützliche Komfortfunktionen: De nombreuses fonctionnalités utiles vous attendent pour votre confort :



TIMERS AND CALENDARS / TIMER UND ZEITPLÄNE/ MINUTERIE ET CALENDRIER

Make your daily life easier with timers and calendars.
Wake up relaxed with the simulated sunrise.

Unterstützen Sie Ihren Alltag mit Timern und Zeitplänen. Entwickeln Sie eigene Lichtroutinen und machen Sie Ihr Leben leichter.

Facilitez-vous la vie à l'aide de la fonction minuterie et calendrier.
Réveillez-vous en douceur grâce au simulateur de lever de soleil



LIGHT ALARM CLOCK / LICHTWECKER/ REVEIL LUMINEUX

You'd rather not start your day in a bad mood? Wake up relaxed with the simulated sunrise.

Keine Lust mit schlechter Laune in den Tag zu starten? Entspannt aufwachen mit dem simulierten Sonnenaufgang.

Pas envie de commencer la journée de mauvaise humeur ? Réveillez-vous en douceur grâce au simulateur de lever de soleil.



DISCO FUNCTION/MODE / DISCOFUNKTION/MODUS/ FONCTION/MODE DISCO

For the perfect party mood, the disco function synchronises the light to the beat of your favourite songs.

Für die perfekte Partystimmung schaltet die Discofunktion das Licht passend zum Beat Ihres Lieblingssongs.

Pour une ambiance festive parfaite, la fonction disco enclenche le luminaire au rythme de votre chanson préférée.



PRESENCE SIMULATOR / ANWESENHEITSSIMULATION/ SIMULATEUR DE PRESENCE

Protect your home with the convenient presence simulator. Variable time intervals allow the system to turn the lights on and off to simulate your presence at home and deter unwanted guests.

Schütze Sie Ihr Zuhause mit der komfortablen Anwesenheitssimulation. Dank variabler Zeitintervalle simuliert das System durch Ein- und Ausschalten der Beleuchtung die Anwesenheit im Haus und schreckt so ungebetene Gäste ab.

Protégez votre domicile à l'aide du très pratique simulateur de présence. Le système simule votre présence en allumant et en éteignant les lumières à intervalles variables et décourage ainsi les invités indésirables.

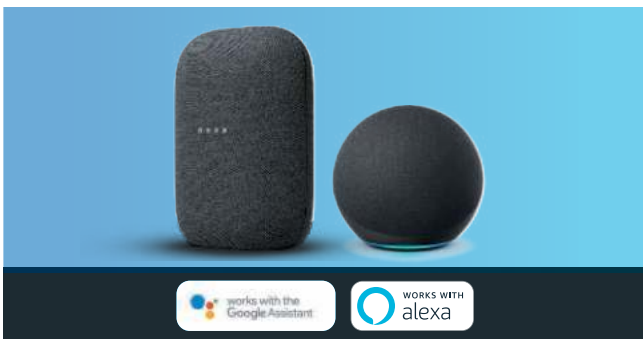

VOICE COMMANDS / SPRACHSTEUERUNG/COMMANDE VOCALE

More convenient! Turn the light on whenever you want with only a voice command.

Noch komfortabler! Mit nur einem Sprachbefehl schaltet sich das Licht nach Ihren Wünschen an und aus.

C'est encore plus confortable ! Allumez votre luminaire comme vous le souhaitez d'une simple commande vocale.

Control options

Steuerungsmöglichkeiten
Possibilités de commande



Set your smart home as you prefer! With the app, voice commands, or remote control.

Steuern Sie Ihr Smart Home wie Sie es möchten! Via App, Sprachsteuerung oder mit der Fernbedienung.

Commandez votre Smart Home comme vous le souhaitez ! Via l'appli, la commande vocale ou la télécommande.



APP CONTROL

Use the free app for smartphone, tablet, or smartwatch.

Nutzen Sie die kostenlose App für das Smartphone, Tablet oder die Smartwatch.

Utilisez l'appli gratuite sur votre smartphone, votre tablette ou votre montre connectée.



VOICE COMMANDS

Use intelligent voice assistants such as Google Home and Amazon Alexa.

Nutzen Sie intelligente Sprachassistenten wie Google Home und Amazon Alexa.

Utilisez des assistants vocaux intelligents comme Google Home ou Amazon Alexa.



REMOTE CONTROL

Use the practical remote connect.z operation at any time.

Nutzen Sie auch jederzeit die praktische connect.z Fernbedienung.

Vous pouvez aussi utiliser à tout moment la télécommande connect.z.



CONNECT.Z ACCESSORIES

Use clever accessories such as the movement sensor and much more.

Nutzen Sie cleveres Zubehör wie z.B. den Bewegungssensor uvm.

Utilisez des accessoires malins tels que le capteur de mouvement et bien d'autres encore.



DIMMER FUNCTION

Use the practical dimmer function via app, speech command or remote control.

Nutzen Sie die praktische Dimmfunktion via App, Sprachbefehl oder Fernbedienung.

Utilisez la fonction de gradation via l'appli, la commande vocale ou la télécommande.

One system, many possibilities!

Ein System – viele Möglichkeiten!
Un système, de nombreuses possibilités!

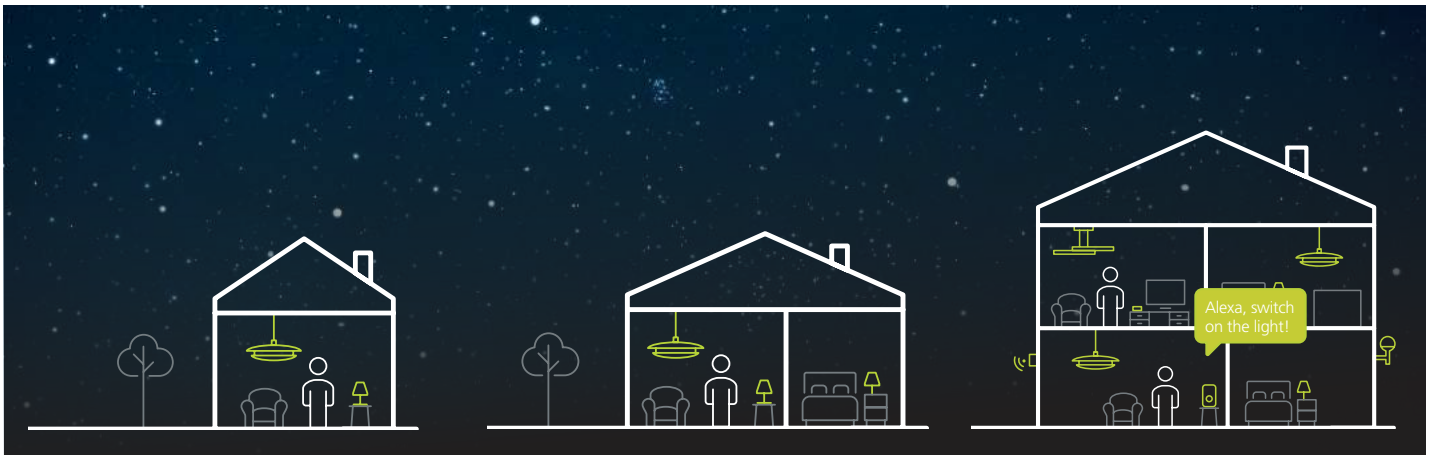

No matter how you start, you can integrate new products into your connect.z system at any time and gradually expand your smart home.
Egal wie Sie starten, Sie können jederzeit neue Produkte in Ihr connect.z System integrieren und Ihr smartes Zuhause nach und nach erweitern.
Quel que soit votre choix, vous pouvez à tout moment intégrer de nouveaux produits à votre système connect.z et améliorer progressivement votre maison intelligente.



All you need to start is a connect.z product and the remote control. No internet connection is required and you have access to:

Sie benötigen zum Start lediglich ein connect.z Produkt und die Fernbedienung. Es wird kein Internetzugang benötigt und Sie haben Zugriff auf:

Pour démarrer, il vous suffit d'un produit connect.z et de la télécommande. Aucune connexion Internet n'est nécessaire. Vous avez accès aux :

Standard functions:

Standardfunktionen:

Fonctionnalités standard :

- › Select colour/ Farbauswahl/ sélection de couleur
- › Change colour/ Farbwechsel/ changement de couleur
- › Dim/ Dimmen/ gradation
- › Favourites (2x)/ Favoriten (2x)/ favoris (2x)
- › Groups (3x)/ Gruppen (3x)/ groupes (3x)
- › Candle mode/ Kerzenmodus/ mode bougie



Besides the standard functions, would you also like access to the practical convenience features? Then you need only your smartphone or tablet and the Awox app. This app allows you to control your lights via Bluetooth®.

Sie möchten zu den Standardfunktionen auch noch Zugriff auf die praktischen Komfortfunktionen haben? Dann benötigen Sie nur Ihr Smartphone oder Tablet und die Awox App. Mit der App haben Sie die Möglichkeit, Ihre Leuchten über Bluetooth® zu steuern.

Outre les options standard, vous souhaitez également pouvoir utiliser les fonctionnalités de confort les plus pratiques ? Pour cela, vous avez seulement besoin de votre smartphone ou de votre tablette et de l'appli Awox. L'appli vous permet de commander vos luminaires via Bluetooth®.

Standard functions + convenience features/ Standardfunktionen + Komfortfunktionen / Fonctionnalités standard + confort

- › Light alarm clock/ Lichtwecker/ réveil lumineux
- › Presence simulation/ Anwesenheitssimulation/ simulateur de présence
- › Disco function/ Discofunktion/ fonction disco
- › Timers & timetables /Timer & Zeitpläne/ minuteur et calendrier
- › Accessories can be incorporated/ Einbindung von Zubehör möglich/ connexion d'accessoires possible



Use the system's full potential and control your smart home through the Awox app using WIFI or Bluetooth® as well as integrating a voice assistant into the system. This gives you:

Nutzen Sie das volle Potenzial des Systems und steuern Sie Ihr Smart Home über die Awox App mithilfe von WLAN oder Bluetooth® und integrieren Sie zusätzlich noch einen Sprachassistenten in das System. So mit erhalten Sie:

Exploitez tout le potentiel du système en commandant votre Smart Home grâce à l'appli Awox via le réseau Wi-Fi ou Bluetooth®, et intégrez également un assistant vocal au système. Vous obtenez ainsi :

Standard functions + convenience features + voice commands*

Standardfunktionen + Komfortfunktionen + Sprachsteuerung*

Fonctionnalités standard + confort + commande vocale*

- › Amazon Alexa or Google Home/ Amazon Alexa oder Google Home/ Amazon Alexa ou Google Home

- * Use a voice assistant with integrated bridge.
- * Nutzen Sie einen Sprachassistenten mit integrierter Bridge.
- * Utilisez un assistant vocal avec Bridge intégré.

You already have connect-c luminaires from the previous system! What now?

Sie besitzen bereits connect-c Leuchten des Vorgängersystems! Was nun?
Vous disposez déjà de luminaires connect-c de l'ancien système! Que faire ?

No problem! The previous connect-c products are compatible with the new connect.z system.
Kein Problem! Die bisherigen connect-c Produkte sind mit dem neuen connect.z System kompatibel.
Aucun problème! Les anciens produits connect-c sont compatibles avec le nouveau système connect.z.

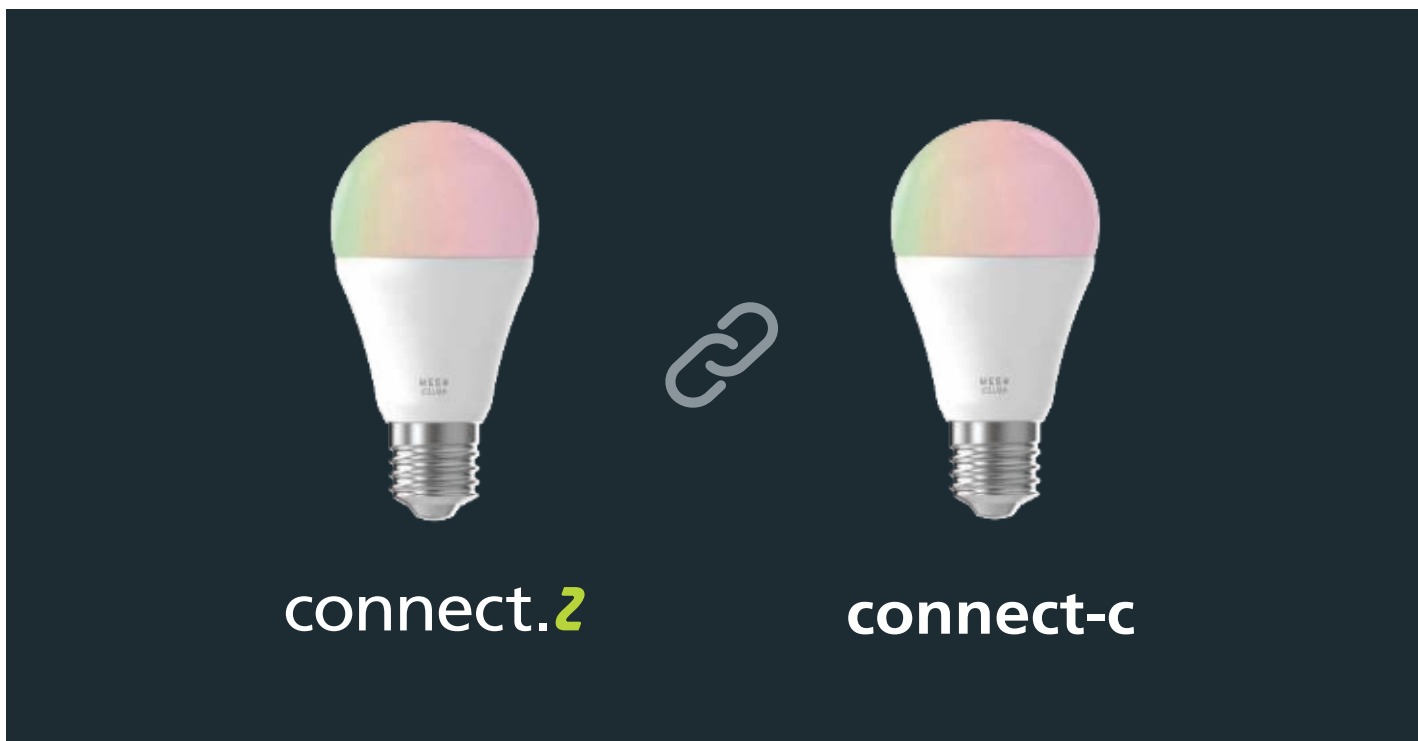

EGLO connect-c - connect.z

The existing EGLO connect-c system is compatible with the new EGLO connect.z system. You don't need to switch from the existing Bluetooth low energy system to the new open protocol ZigBee 3.0. Lights from EGLO connect-c can be incorporated into the existing EGLO connect.z system.

EGLO connect-c - connect.z

Das bestehende EGLO connect-c System ist mit dem neuen EGLO connect.z System kompatibel. Sie müssen nicht von dem bestehendem Bluetooth low energy System auf das neue offene Protokoll ZigBee 3.0 umsteigen. Leuchten von EGLO connect-c können in das bestehende EGLO connect.z System eingebunden werden.

EGLO connect-c - connect.z

Le système EGLO connect-c existant est compatible avec le nouveau système EGLO connect.z. Vous n'avez pas besoin de passer du système Bluetooth à basse consommation existant au nouveau protocole ouvert ZigBee 3.0. Les luminaires EGLO connect-c peuvent être intégrés au système EGLO connect.z existant.



99106



120°, 12 m
20 sec. - 10 min.

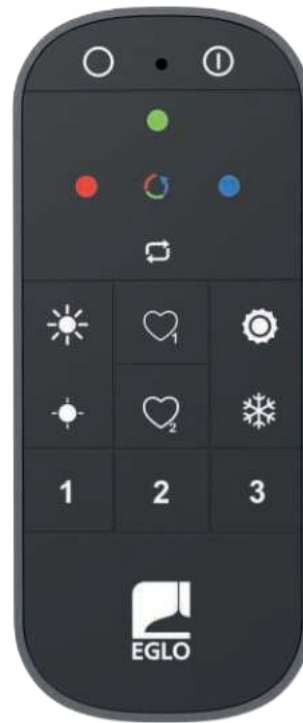

99099

99106 CONNECT-Z SENSOR

accessory; plastic, white
Zubehör; Kunststoff, weiss
accessoire; plastique, blanc

L 75, H 75, A 70



AA,
LR6 HP



2900mA,
1,5V



IP44



9 002759 991067



99099 CONNECT Z

remote control; plastic, grey
Fernbedienung; Kunststoff, grau
Télécommande; plastique, gris

L 122, B 54, H 18



AAA,
R03P



1,5V



9 002759 990992





900387



900388



900387 ANCHORENA-Z

ceiling light; wood, steel, brown, black / plastic, white
Deckenleuchte; Holz, Stahl, braun, schwarz / Kunststoff, weiss
plafonnier; bois, acier, marron, noir / plastique, blanc

L 1230, B 80, H 110



35W



3980 lm



Remote,
App



9 008606 243662



900388 ANCHORENA-Z

pendant light; wood, steel, brown, black / plastic, white
Hängeleuchte; Holz, Stahl, braun, schwarz / Kunststoff, weiss
luminaire en suspension; bois, acier, marron, noir / plastique, blanc

L 1230, B 55, H 1100



35W



3980 lm



Remote,
App



9 008606 243679

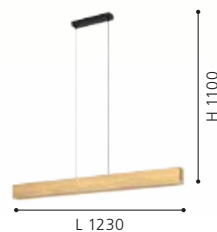

900391 ANCHORENA-Z

table light; wood, steel, brown, black / plastic, white
Tischleuchte; Holz, Stahl, braun, schwarz / Kunststoff, weiss
luminaire de table; bois, acier, marron, noir / plastique, blanc

L 75, B 55, H 465, Base: B 160, T 120



16W



1800 lm



Remote,
App



9 008606 243693

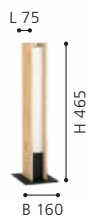



900391



900392 ANCHORENA-Z

floor light; wood, steel, brown, black / plastic, white
 Stehleuchte; Holz, Stahl, braun, schwarz / Kunststoff, weiss
 lampadaire; bois, acier, marron, noir / plastique, blanc

L 105, B 55, H 1500, Base: B 240, T 210



35W



3980lm



Remote,
App



L 105



B 240



9 008606 243709

900392





99679

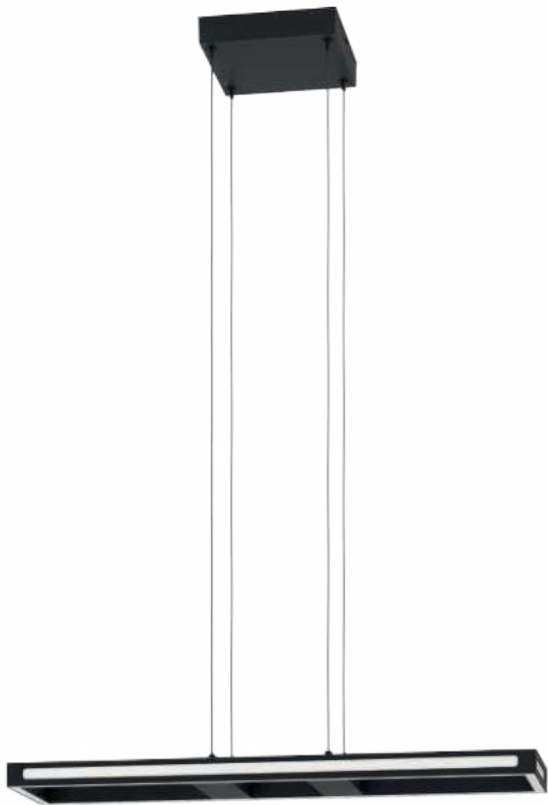

99678



99681



99679 SALVILANAS-Z

ceiling light; aluminium, steel, black / plastic, white
Deckenleuchte; Alu, Stahl, schwarz / Kunststoff, weiss
plafonnier; aluminium, acier, noir / plastique, blanc

L 770, B 200, H 75



21W 2700lm Remote, App



9 002759 996796



99678 SALVILANAS-Z

pendant light; aluminium, steel, black / plastic, white
Hängeleuchte; Alu, Stahl, schwarz / Kunststoff, weiss
luminaire en suspension; aluminium, acier, noir / plastique, blanc

L 770, B 200, H 1100



21W 2700lm Remote, App



9 002759 996789



99681 SALVILANAS-Z

pendant light; aluminium, steel, black / plastic, white
Hängeleuchte; Alu, Stahl, schwarz / Kunststoff, weiss
luminaire en suspension; aluminium, acier, noir / plastique, blanc

L 1160, B 200, H 1100



33W 4300lm Remote, App



9 002759 996819





99682



99683



99682 SALVILANAS-Z

table light; aluminium, steel, black / plastic, white
 Tischleuchte; Alu, Stahl, schwarz / Kunststoff, weiss
 luminaire de table; aluminium, acier, noir / plastique, blanc

L 160, B 35, H 425, Base: B 240, T 160



9 002759 996826



99683 SALVILANAS-Z

floor light; aluminium, steel, black / plastic, white
 Stehleuchte; Alu, Stahl, schwarz / Kunststoff, weiss
 lampadaire; aluminium, acier, noir / plastique, blanc

L 200, B 35, H 1305, Base: B 280, T 180



9 002759 996833

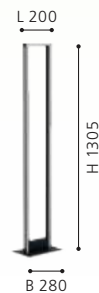



900479

LED



900478

LED

900479 LOBINERO-Z

pendant light; aluminium, steel, black / plastic, white
 Hängeleuchte; Alu, Stahl, schwarz / Kunststoff, weiss
 luminaire en suspension; aluminium, acier, noir / plastique, blanc

H 1100, Ø 580

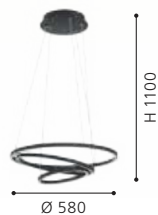

900478 LOBINERO-Z

pendant light; aluminium, steel, white / plastic, white
 Hängeleuchte; Alu, Stahl, weiss / Kunststoff, weiss
 luminaire en suspension; aluminium, acier, blanc / plastique, blanc

H 1100, Ø 580

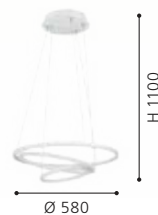

900398 ZILLERIO-Z

pendant light; steel, aluminium, black / plastic, white
 Hängeleuchte; Stahl, Alu, schwarz / Kunststoff, weiss
 luminaire en suspension; acier, aluminium, noir / plastique, blanc

L 1160, B 300, H 1100

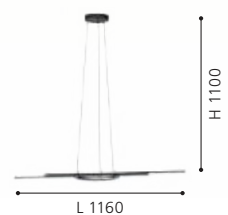
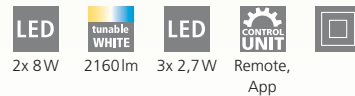



900398

LED

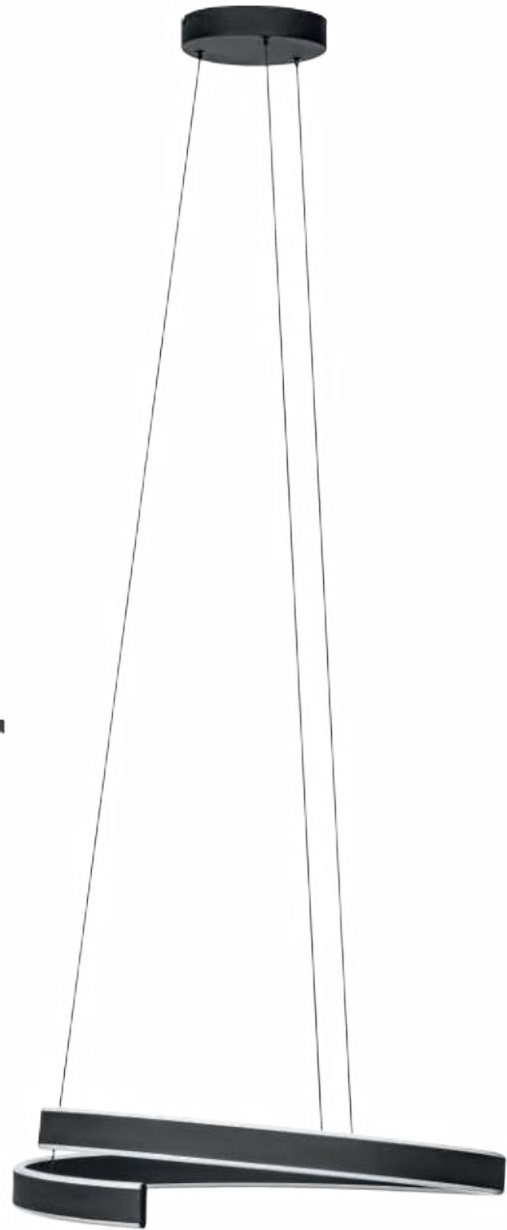

900404

LED

900404 ANDABAIA-Z

pendant light; aluminium, steel, black / plastic, white
 Hängeleuchte; Alu, Stahl, schwarz / Kunststoff, weiss
 luminaire en suspension; aluminium, acier, noir / plastique, blanc

H 1540, Ø 600

LED

42,5W

tunable
WHITE

5300lm

CONTROL
UNIT

Remote,
App



9 008606 242818

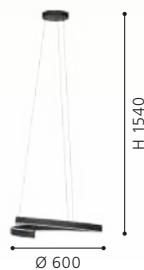



900336

LED



900337

LED



900338

LED



900336 TELIMBELA-Z

spot; steel, black
Spot; Stahl, schwarz
spot; acier, noir

H 97, Ø 250

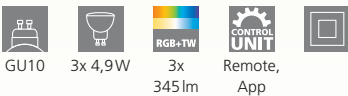

GU10 3x 4,9W 3x 345lm Remote, App



9 008606 239948



900337 TELIMBELA-Z

spot; steel, black
Spot; Stahl, schwarz
spot; acier, noir

L 580, B 80, H 97

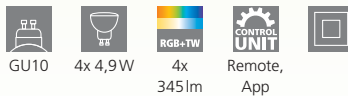

GU10 4x 4,9W 4x 345lm Remote, App



9 008606 239955



900338 TELIMBELA-Z

spot; steel, white
Spot; Stahl, weiss
spot; acier, blanc

H 97, Ø 250

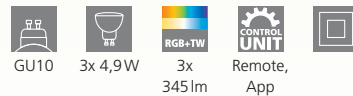

GU10 3x 4,9W 3x 345lm Remote, App



9 008606 239962





900339

LED

900339 TELIMBELA-Z

spot; steel, white
 Spot; Stahl, weiss
 spot; acier, blanc

L 580, B 80, H 97



GU10



4x 4,9W



4x
 345 lm



Remote,
 App



9 008606 239979



INCL.





900407

LED



900406

LED



900407 TOLLOS-Z

ceiling light; aluminium, steel, black, white / plastic, white
Deckenleuchte; Alu, Stahl, schwarz, weiss / Kunststoff, weiss
plafonnier; aluminium, acier, noir, blanc / plastique, blanc

H 130, Ø 550



3x 11 W



3750 lm



Remote,
App



9 008606 243808



900406 TOLLOS-Z

ceiling light; aluminium, steel, black, white / plastic, white
Deckenleuchte; Alu, Stahl, schwarz, weiss / Kunststoff, weiss
plafonnier; aluminium, acier, noir, blanc / plastique, blanc

H 130, Ø 400



3x 7,5 W



2700 lm



Remote,
App



9 008606 243792



900439 ROMA0-Z

ceiling light; steel, white / fabric, plastic, white
Deckenleuchte; Stahl, weiss / Textil, Kunststoff, weiss
plafonnier; acier, blanc / tissu, plastique, blanc

H 150, Ø 570



35 W



3500 lm



Remote,
App



9 008606 243914



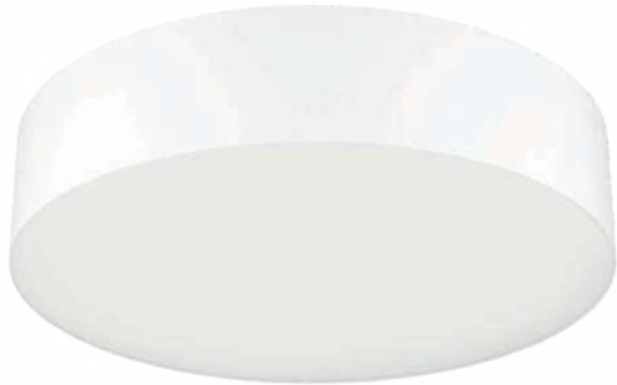

900439



900441



900442



900441 ROMAO-Z

ceiling light; steel, white / fabric, plastic, taupe, white
 Deckenleuchte; Stahl, weiss / Textil, Kunststoff, taupe, weiss
 plafonnier; acier, blanc / tissu, plastique, taupe, blanc

H 150, Ø 570

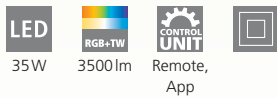

900442 ROMAO-Z

ceiling light; steel, white / fabric linen, plastic, grey, white
 Deckenleuchte; Stahl, weiss / Textil Leinen, Kunststoff, grau, weiss
 plafonnier; acier, blanc / tissu de lin, plastique, gris, blanc

H 150, Ø 570

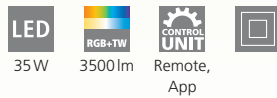

9 008606 243921



9 008606 243938





900408



900409



900411



900408 MONTEMORELOS-Z

ceiling light; aluminium, white / plastic with crystal effect, white
Deckenleuchte; Alu, weiss / Kunststoff m. Kristalleffekt, weiss
plafonnier; aluminium, blanc / plastique avec effet cristal, blanc

H 50, Ø 420

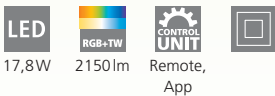

17,8W 2150lm Remote, App

900409 MONTEMORELOS-Z

ceiling light; aluminium, white / plastic with crystal effect, white
Deckenleuchte; Alu, weiss / Kunststoff m. Kristalleffekt, weiss
plafonnier; aluminium, blanc / plastique avec effet cristal, blanc

H 70, Ø 570

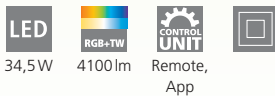

34,5W 4100lm Remote, App

900411 MONTEMORELOS-Z

ceiling light; aluminium, black / plastic with crystal effect, white
Deckenleuchte; Alu, schwarz / Kunststoff m. Kristalleffekt, weiss
plafonnier; aluminium, noir / plastique avec effet cristal, blanc

H 50, Ø 420

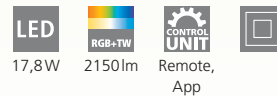

17,8W 2150lm Remote, App



9 008606 243815



9 008606 243822



9 008606 243839





900412



900636



900477

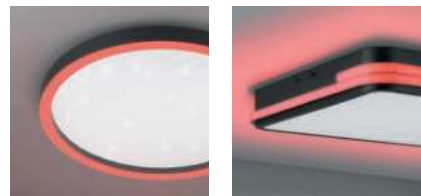

MONTEMORELOS-Z, GENOVESE-Z

The frame of these luminaires can switch between the RGB colors, the inner part can reproduce different white tones between 2700K and 6500K. By controlling via app or remote control, individual lighting effects can be set.

Der Rahmen dieser Leuchten kann zwischen den RGB Farbtönen wechseln, der Innenteil kann verschiedene Weißtöne zwischen 2700K und 6500K wiedergeben. Durch Steuerung per App oder Fernbedienung können so individuelle Lichtspiele eingestellt werden.

Le cadre de cette luminaires peut basculer entre les couleurs RVB, la partie intérieure peut reproduire différents tons blancs entre 2700K et 6500K. En contrôlant via l'application ou la télécommande, des effets d'éclairage individuels peuvent être définis.

900412 MONTEMORELOS-Z

ceiling light; aluminium, black / plastic with crystal effect, white
Deckenleuchte; Alu, schwarz / Kunststoff m. Kristalleffekt, weiss
plafonnier; aluminium, noir / plastique avec effet cristal, blanc

H 70, Ø 570

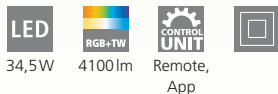

34,5W 4100lm Remote, App



9 008606 243846



900636 TOTARI-Z

ceiling light; steel, white / plastic with crystal effect, white
Deckenleuchte; Stahl, weiss / Kunststoff m. Kristalleffekt, weiss
plafonnier; acier, blanc / plastique avec effet cristal, blanc

H 70, Ø 380

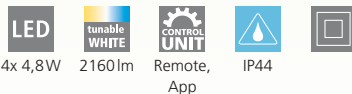

4x 4,8W 2160lm Remote, App



9 008606 245208

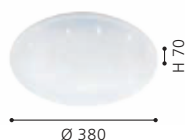

900477 GENOVESE-Z

ceiling light; aluminium, steel, black / plastic, white
Deckenleuchte; Alu, Stahl, schwarz / Kunststoff, weiss
plafonnier; aluminium, acier, noir / plastique, blanc

L 470, B 470, H 70



22W 3000lm Remote, App



9 008606 252763





900322



900323



900324



900322 PARRAPOS-Z

ceiling light; steel, black / plastic, white
Deckenleuchte; Stahl, schwarz / Kunststoff, weiss
plafonnier; acier, noir / plastique, blanc

L 445, B 300, H 70



900323 PARRAPOS-Z

ceiling light; steel, black / plastic, white
Deckenleuchte; Stahl, schwarz / Kunststoff, weiss
plafonnier; acier, noir / plastique, blanc

L 340, B 300, H 45



900324 PARRAPOS-Z

wall light; steel, black / plastic, white
Wandleuchte; Stahl, schwarz / Kunststoff, weiss
applique; acier, noir / plastique, blanc

L 200, H 240, A 50



9 008606 231256



9 008606 231263



9 008606 231270





900319



900321



900319 PARRAPOS-Z

ceiling light; steel, black / plastic, white
 Deckenleuchte; Stahl, schwarz / Kunststoff, weiss
 plafonnier; acier, noir / plastique, blanc

L 615, B 450, H 80



900321 PARRAPOS-Z

ceiling light; steel, black / plastic, white
 Deckenleuchte; Stahl, schwarz / Kunststoff, weiss
 plafonnier; acier, noir / plastique, blanc

L 545, B 445, H 90



9 008606 231232

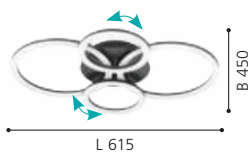

9 008606 231249





900315

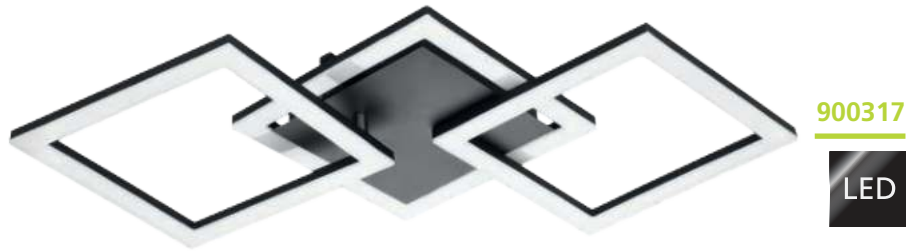

900317

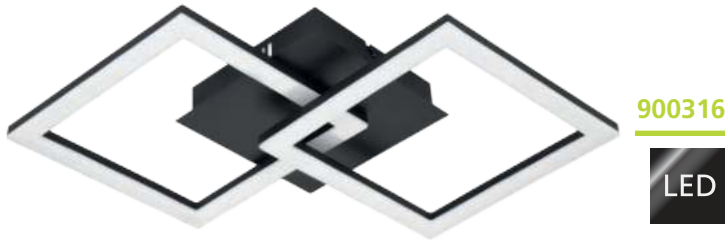

900316



900315 PARANDAY-Z

ceiling light; steel, black / plastic, white
Deckenleuchte; Stahl, schwarz / Kunststoff, weiss
plafonnier; acier, noir / plastique, blanc

L 470, B 225, H 60



15,5W



1800lm



Remote,
App



900316 PARANDAY-Z

ceiling light; steel, black / plastic, white
Deckenleuchte; Stahl, schwarz / Kunststoff, weiss
plafonnier; acier, noir / plastique, blanc

L 525, B 310, H 60



21,5W



2500lm



Remote,
App



900317 PARANDAY-Z

ceiling light; steel, black / plastic, white
Deckenleuchte; Stahl, schwarz / Kunststoff, weiss
plafonnier; acier, noir / plastique, blanc

L 650, B 310, H 60



32,4W



4000lm



Remote,
App



9 008606 231195

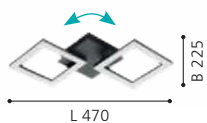

9 008606 231201



9 008606 231218

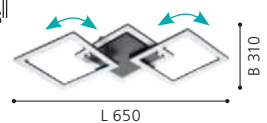



900318



900566

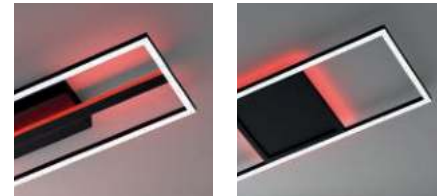

900567



CALAGRANO-Z

These lights have individually controllable light settings on the inside and outside of the frame.

Diese Leuchten verfügen über individuell steuerbare Lichteinstellungen der Rahmen innen und außen.

Ces lumières ont des paramètres d'éclairage contrôlables individuellement du cadre.

900318 PARANDAY-Z

ceiling light; steel, black / plastic, white
Deckenleuchte; Stahl, schwarz / Kunststoff, weiss
plafonnier; acier, noir / plastique, blanc

L 470, B 430, H 65



900566 CALAGRANO-Z

ceiling light; aluminium, steel, black / plastic, white
Deckenleuchte; Alu, Stahl, schwarz / Kunststoff, weiss
plafonnier; aluminium, acier, noir / plastique, blanc

L 640, B 240, H 45



900567 CALAGRANO-Z

ceiling light; aluminium, steel, black / plastic, white
Deckenleuchte; Alu, Stahl, schwarz / Kunststoff, weiss
plafonnier; aluminium, acier, noir / plastique, blanc

L 640, B 220, H 50



9 008606 231225



9 008606 244683



9 008606 244690





900481



900484



900483



900481 PADROGIANO-Z

ceiling light; steel, white / plastic, white
Deckenleuchte; Stahl, weiss / Kunststoff, weiss
plafonnier; acier, blanc / plastique, blanc

L 450, B 450, H 50



26,2W



3800 lm



Remote,
App



9 008606 244164



900483 PADROGIANO-Z

ceiling light; steel, white / plastic, white
Deckenleuchte; Stahl, weiss / Kunststoff, weiss
plafonnier; acier, blanc / plastique, blanc

L 450, B 450, H 50



27,9W



3600 lm



Remote,
App



9 008606 244188



900484 PADROGIANO-Z

ceiling light; steel, white / plastic, white
Deckenleuchte; Stahl, weiss / Kunststoff, weiss
plafonnier; acier, blanc / plastique, blanc

L 595, B 595, H 50



35,5W



4800 lm



Remote,
App



9 008606 244195





900486

LED



PADROGIANO-Z

These lights have individually controllable light settings on the inside and outside of the frame.

Diese Leuchten verfügen über individuell steuerbare Lichteinstellungen der Rahmen innen und außen.

Ces lumières ont des paramètres d'éclairage contrôlables individuellement du cadre.



900487

LED



900486 PADROGIANO-Z

ceiling light; steel, white / plastic, white
Deckenleuchte; Stahl, weiss / Kunststoff, weiss
plafonnier; acier, blanc / plastique, blanc

H 50, Ø 450



26,5W

3300lm

Remote,
App



9 008606 244218



900487 PADROGIANO-Z

ceiling light; steel, white / plastic, white
Deckenleuchte; Stahl, weiss / Kunststoff, weiss
plafonnier; acier, blanc / plastique, blanc

H 50, Ø 595



35W

4600lm

Remote,
App



9 008606 244225





900482



PADROGIANO-Z

The frame of these luminaires can switch between the RGB colors, the inner part can reproduce different white tones between 2700K and 6500K. By controlling via app or remote control, individual lighting effects can be set.

Der Rahmen dieser Leuchten kann zwischen den RGB Farbtönen wechseln, der Innenteil kann verschiedene Weißtöne zwischen 2700K und 6500K wiedergeben. Durch Steuerung per App oder Fernbedienung können so individuelle Lichtspiele eingestellt werden.

Le cadre de cette luminaires peut basculer entre les couleurs RVB, la partie intérieure peut reproduire différents tons blancs entre 2700K et 6500K.

En contrôlant via l'application ou la télécommande, des effets d'éclairage individuels peuvent être définis.



900482 PADROGIANO-Z

ceiling light; steel, white / plastic, white
Deckenleuchte; Stahl, weiss / Kunststoff, weiss
plafonnier; acier, blanc / plastique, blanc

L 1200, B 300, H 50



42,5 W 6000 lm Remote, App



9 008606 244171



900485 PADROGIANO-Z

ceiling light; steel, white / plastic, white
Deckenleuchte; Stahl, weiss / Kunststoff, weiss
plafonnier; acier, blanc / plastique, blanc

L 1200, B 300, H 50

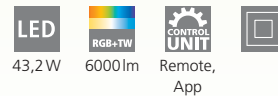

43,2 W 6000 lm Remote, App



9 008606 244201

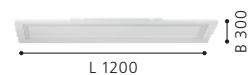

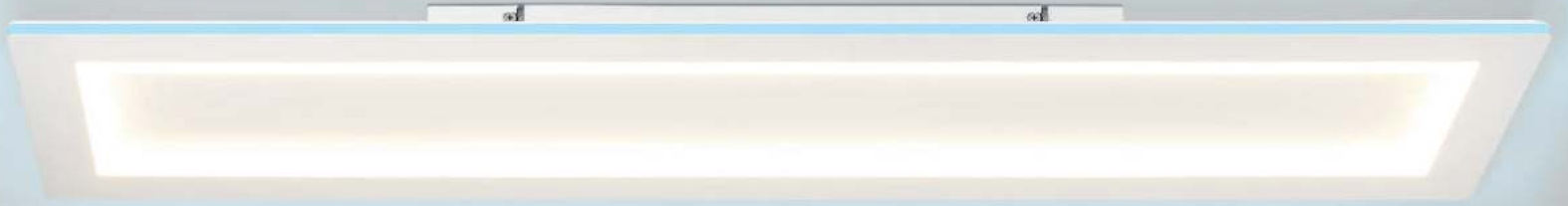

900485





99601



900075



99603



900075 VALDELAGRANO-Z

pendant light; steel, wood, black / fabric, white
 Hängeleuchte; Stahl, Holz, schwarz / Textil, weiss
 luminaire en suspension; acier, bois, noir / tissu, blanc

L 1000, B 105, H 1100

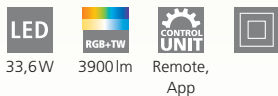

9 008606 222094



99603 SIMOLARIS-Z

pendant light; aluminium, steel, black / plastic, white
 Hängeleuchte; Alu, Stahl, schwarz / Kunststoff, weiss
 luminaire en suspension; aluminium, acier, noir / plastique, blanc

L 1220, B 55, H 1100



9 002759 996031

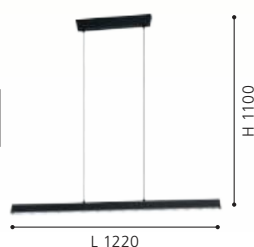

99601 SIMOLARIS-Z

ceiling light; aluminium, steel, black / plastic, white
 Deckenleuchte; Alu, Stahl, schwarz / Kunststoff, weiss
 plafonnier; aluminium, acier, noir / plastique, blanc

L 470, B 55, H 110

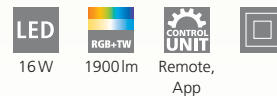

9 002759 996017

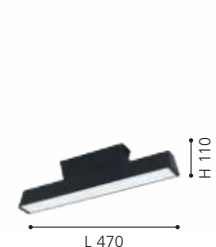



99602

LED

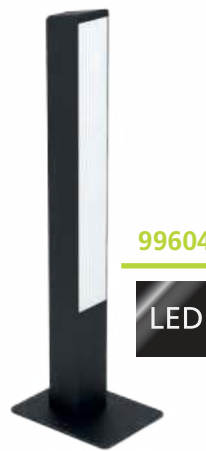

99604

LED

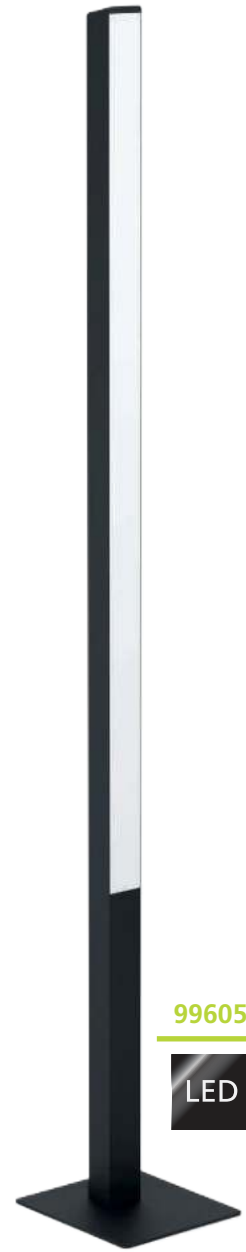

99605

LED

99602 SIMULARIS-Z

ceiling light; aluminium, steel, black / plastic, white
Deckenleuchte; Alu, Stahl, schwarz / Kunststoff, weiss
plafonnier; aluminium, acier, noir / plastique, blanc

L 1220, B 55, H 110

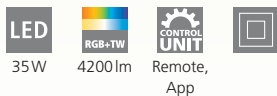

35W 4200lm Remote, App



9 002759 996024



L 1220

99604 SIMULARIS-Z

table light; aluminium, steel, black / plastic, white
Tischleuchte; Alu, Stahl, schwarz / Kunststoff, weiss
luminaire de table; aluminium, acier, noir / plastique, blanc

L 55, B 55, H 515, Base: B 160, T 120



16W 1900lm Remote, App



9 002759 996048



B 160

99605 SIMULARIS-Z

floor light; aluminium, steel, black / plastic, white
Stehleuchte; Alu, Stahl, schwarz / Kunststoff, weiss
lampadaire; aluminium, acier, noir / plastique, blanc

L 55, B 55, H 1615, Base: B 240, T 210



35W 4200lm Remote, App



9 002759 996055



B 240

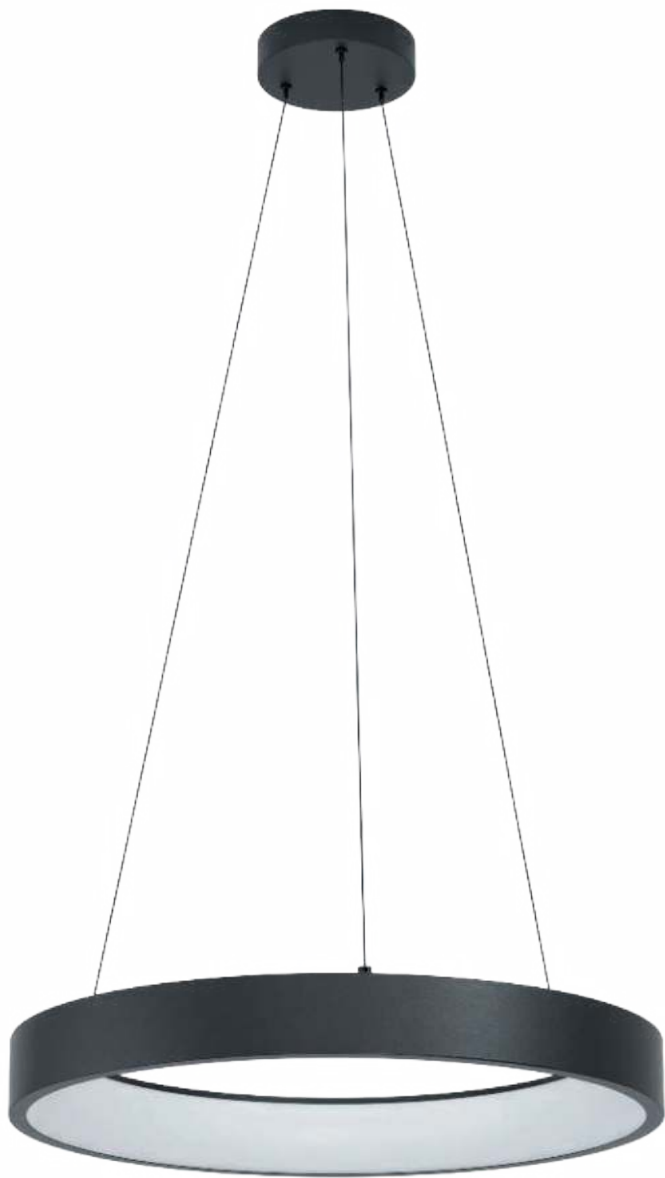

900068



900067



900069



900068 MARGHERA-Z

pendant light; steel, black / plastic, white
 Hängeleuchte; Stahl, schwarz / Kunststoff, weiss
 luminaire en suspension; acier, noir / plastique, blanc

H 1100, Ø 600



4x 6,5W



3120lm



Remote,
App



9 008606 222032

900067 MARGHERA-Z

ceiling light; steel, black / plastic, white
 Deckenleuchte; Stahl, schwarz / Kunststoff, weiss
 plafonnier; acier, noir / plastique, blanc

H 110, Ø 600



4x 6,5W



3120lm



Remote,
App



9 008606 222025



900069 MARGHERA-Z

wall light; steel, black / plastic, white
 Wandleuchte; Stahl, schwarz / Kunststoff, weiss
 applique; acier, noir / plastique, blanc

L 270, H 305, A 200



4x 4W



1800lm



Remote,
App



9 008606 222049





900071



900072



900071 MARGHERA-Z

table light; steel, black / plastic, white
Tischleuchte; Stahl, schwarz / Kunststoff, weiss
luminaire de table; acier, noir / plastique, blanc

L 270, H 265, Base: Ø 145

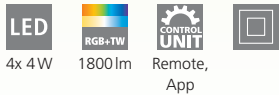

900072 MARGHERA-Z

floor light; steel, black / plastic, white
Stehleuchte; Stahl, schwarz / Kunststoff, weiss
lampadaire; acier, noir / plastique, blanc

L 270, B 305, H 1690, Base: Ø 305

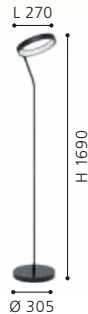



99673

LED



99674

LED



99675

LED



99673 CAMINALES-Z

ceiling light; steel, black
Deckenleuchte; Stahl, schwarz
plafonnier; acier, noir

L 125, B 125, H 120



GU10



1x 5W



1x
345lm



Remote,
App



99674 CAMINALES-Z

ceiling light; steel, black
Deckenleuchte; Stahl, schwarz
plafonnier; acier, noir

L 240, B 125, H 120



GU10



2x 5W



2x
345lm



Remote,
App



99675 CAMINALES-Z

ceiling light; steel, black
Deckenleuchte; Stahl, schwarz
plafonnier; acier, noir

L 240, B 240, H 120



GU10



4x 5W



4x
345lm



Remote,
App





99669

LED



DESIGN
HIGHLIGHT
DETAIL



99671

LED



99672

LED

99669 SALICETO-Z

recessed light; aluminium, black
Einbauleuchte; Alu, schwarz
luminaire encastrable; aluminium, noir

H 46, Ø 88, ET 50

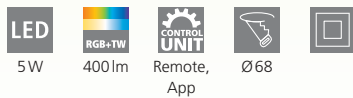

99671 SALICETO-Z

recessed light; aluminium, white
Einbauleuchte; Alu, weiss
luminaire encastrable; aluminium, blanc

H 46, Ø 88, ET 50

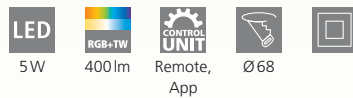

99672 SALICETO-Z

recessed light; aluminium, satin nickel
Einbauleuchte; Alu, nickel-matt
luminaire encastrable; aluminium, nickel mat

H 46, Ø 88, ET 50

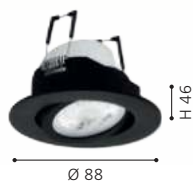
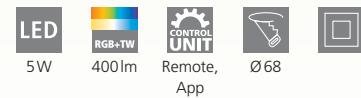



99677

LED



99676

LED

DIMMABLE
VIA REMOTE
AND APP



99677 LOMALTAS-Z

ceiling light; steel, wood, black, brown / plastic, white
Deckenleuchte; Stahl, Holz, schwarz, braun / Kunststoff, weiss
plafonnier; acier, bois, noir, marron / plastique, blanc

L 770, B 495, H 85



4x 8W



4400lm



Remote,
App



99676 LOMALTAS-Z

ceiling light; steel, wood, black, brown / plastic, white
Deckenleuchte; Stahl, Holz, schwarz, braun / Kunststoff, weiss
plafonnier; acier, bois, noir, marron / plastique, blanc

L 580, B 350



4x 8W



4400lm



Remote,
App



9 002759 996772

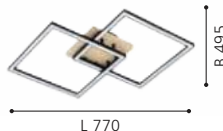

9 002759 996765





900019

LED



900021

LED



99588

LED

900019 TABIANO-Z

mirror light; steel, chrome / plastic, white
Spiegelleuchte; Stahl, chrom / Kunststoff, weiss
applique pour miroir; acier, chrome / plastique, blanc

L 605, H 70, A 135

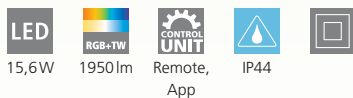

15,6W 1950lm Remote, App

900021 TABIANO-Z

mirror light; steel, chrome / plastic, white
Spiegelleuchte; Stahl, chrom / Kunststoff, weiss
applique pour miroir; acier, chrome / plastique, blanc

L 905, H 70, A 135

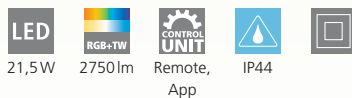

21,5W 2750lm Remote, App

99588 JUAREZA-Z

mirror light; steel, white / mirror
Spiegelleuchte; Stahl, weiss / Spiegel
applique pour miroir; acier, blanc / miroir

L 700, H 500, A 55



20W 2300lm Remote, App



9 008606 221646



9 008606 221653



9 002759 995881





900079

LED

900081

LED



900082

LED

900079 FRAIOLI-Z

ceiling light; aluminium, black / plastic, white
Deckenleuchte; Alu, schwarz / Kunststoff, weiss
plafonnier; aluminium, noir / plastique, blanc

L 1055, B 120, H 65



2x 17W 4800lm Remote, App



9 008606 223565



L 1055

H 65

900081 FRAIOLI-Z

pendant light; aluminium, black / plastic, white
Hängeleuchte; Alu, schwarz / Kunststoff, weiss
luminaire en suspension; aluminium, noir / plastique, blanc

L 1055, B 100, H 1200



2x 17W 4800lm Remote, App



9 008606 223572

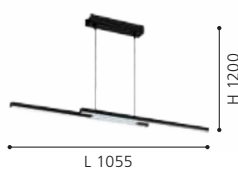

L 1055

H 1200

900082 FRAIOLI-Z

floor light; aluminium, black / plastic, white
Stehleuchte; Alu, schwarz / Kunststoff, weiss
lampadaire; aluminium, noir / plastique, blanc

H 1755, Base: B 280, T 280



2x 17W 4800lm Remote, App



9 008606 223589



B 280

H 1755



900076



900077



900078



900076 FRAIOLI-Z

ceiling light; aluminium, satin nickel / plastic, white
Deckenleuchte; Alu, nickel-matt / Kunststoff, weiss
plafonnier; aluminium, nickel mat / plastique, blanc

L 1055, B 120, H 65



2x 17W 4800lm Remote, App



9 008606 223534



900077 FRAIOLI-Z

pendant light; aluminium, satin nickel / plastic, white
Hängeleuchte; Alu, nickel-matt / Kunststoff, weiss
luminaire en suspension; aluminium, nickel mat / plastique, blanc

L 1055, B 100, H 1200

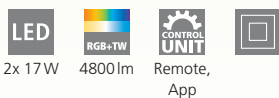

2x 17W 4800lm Remote, App



9 008606 223541



900078 FRAIOLI-Z

floor light; aluminium, satin nickel / plastic, white
Stehleuchte; Alu, nickel-matt / Kunststoff, weiss
lampadaire; aluminium, nickel mat / plastique, blanc

H 1755, Base: B 280, T 280



2x 17W 4800lm Remote, App



9 008606 223558





900001



900002



900084



900001 TOTARI-Z

ceiling light; steel, white / plastic with crystal effect, white
Deckenleuchte; Stahl, weiss / Kunststoff m. Kristalleffekt, weiss
plafonnier; acier, blanc / plastique avec effet cristal, blanc

H 70, Ø 380



4x 4,8W 2160lm Remote, App

900002 TOTARI-Z

ceiling light; steel, white / plastic with crystal effect, white
Deckenleuchte; Stahl, weiss / Kunststoff m. Kristalleffekt, weiss
plafonnier; acier, blanc / plastique avec effet cristal, blanc

H 70, Ø 530

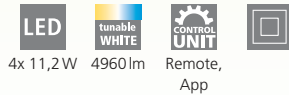

4x 11,2W 4960lm Remote, App

900084 TOTARI-Z

ceiling light; steel, white / plastic, white
Deckenleuchte; Stahl, weiss / Kunststoff, weiss
plafonnier; acier, blanc / plastique, blanc

H 70, Ø 380

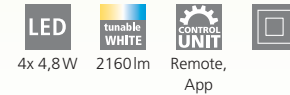

4x 4,8W 2160lm Remote, App



9 008606 221479



9 008606 221486



9 008606 225453



900085

LED



900085 TOTARI-Z

ceiling light; steel, white / plastic, white
Deckenleuchte; Stahl, weiss / Kunststoff, weiss
plafonnier; acier, blanc / plastique, blanc

H 70, Ø 530

LED

tunable
WHITE

CONTROL
UNIT



4x 11,2W

4960lm

Remote,
App



9 008606 225460





900083

LED



900005

LED



900006

LED



900083 LANCIANO-Z

ceiling light; steel, white, transparent / plastic with crystal effect, white, chrome

Deckenleuchte; Stahl, weiss, transparent / Kunststoff m.Kristalleffekt, weiss, chrom

plafonnier; acier, blanc, transparent / plastique avec effet cristal, blanc, chrome
H 80, Ø 450



4x 4,8W

2160lm

Remote,
App

900005 LANCIANO-Z

ceiling light; steel, white, transparent / plastic with crystal effect, white, chrome

Deckenleuchte; Stahl, weiss, transparent / Kunststoff m.Kristalleffekt, weiss, chrom

plafonnier; acier, blanc, transparent / plastique avec effet cristal, blanc, chrome
H 80, Ø 560



4x 11,2W

4960lm

Remote,
App

900006 LANCIANO-Z

ceiling light; steel, white, transparent / plastic with crystal effect, white, chrome

Deckenleuchte; Stahl, weiss, transparent / Kunststoff m.Kristalleffekt, weiss, chrom

plafonnier; acier, blanc, transparent / plastique avec effet cristal, blanc, chrome
H 95, Ø 770



38,1W

5350lm

Remote,
App



9 008606 225446



9 008606 221516



9 008606 221523





900008

LED



900128

LED



900129

LED

900008 CAPASSO-Z

wall / ceiling light; steel, white / plastic, white, chrome
Wand- / Deckenleuchte; Stahl, weiss / Kunststoff, weiss, chrom
applique / plafonnier; acier, blanc / plastique, blanc, chrome

H 70, Ø 340



4x 3,9W 1880lm Remote, App

900128 SILERAS-Z

ceiling light; steel, white / plastic with crystal effect, white
Deckenleuchte; Stahl, weiss / Kunststoff m.Kristalleffekt, weiss
plafonnier; acier, blanc / plastique avec effet cristal, blanc

H 60, Ø 430



3x 7,2W 2700lm Remote, App

900129 SILERAS-Z

ceiling light; steel, white / plastic with crystal effect, white
Deckenleuchte; Stahl, weiss / Kunststoff m.Kristalleffekt, weiss
plafonnier; acier, blanc / plastique avec effet cristal, blanc

H 60, Ø 600

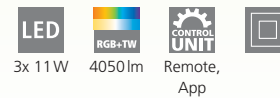

3x 11W 4050lm Remote, App



9 008606 221547



9 008606 226054



9 008606 226061

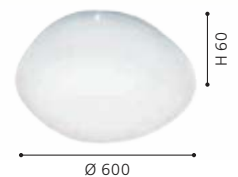



900025



900023, 900025

One frame of the luminaires is rotatable.

Ein Rahmen der Leuchten ist drehbar.

Un cadre de les luminaires est rotatif.

900025 SAVATARILA-Z

ceiling light; steel, black / plastic, white
 Deckenleuchte; Stahl, schwarz / Kunststoff, weiss
 plafonnier; acier, noir / plastique, blanc

L 450, B 450, H 70



4x 2,7W



1320lm



4x 2,7W



Remote,
App



9 008606 221691

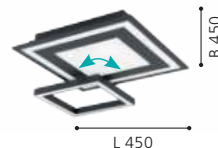



900022



900024



900023



900023 SAVATARILA-Z

ceiling light; steel, white / plastic, white
Deckenleuchte; Stahl, weiss / Kunststoff, weiss
plafonnier; acier, blanc / plastique, blanc

L 450, B 450, H 70

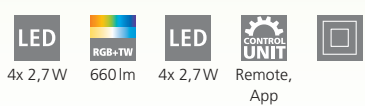

900022 SALITERAS-Z

ceiling light; steel, white / plastic, white
Deckenleuchte; Stahl, weiss / Kunststoff, weiss
plafonnier; acier, blanc / plastique, blanc

L 1160, B 160, H 50



900024 SALITERAS-Z

ceiling light; steel, black / plastic, white
Deckenleuchte; Stahl, schwarz / Kunststoff, weiss
plafonnier; acier, noir / plastique, blanc

L 1160, B 160, H 50

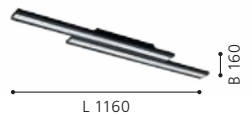
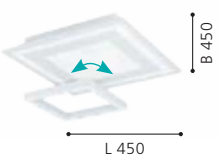



900054



900056



TURCONA-Z

Frameless luminaire

Rahmenlose Leuchte

Luminaire sans cadre



900054 TURCONA-Z

ceiling light; steel, aluminium, white / plastic, white
Deckenleuchte; Stahl, Alu, weiss / Kunststoff, weiss
plafonnier; acier, aluminium, blanc / plastique, blanc

H 60, Ø 300



15,7W



1730lm



Remote,
App



9 008606 221905



900056 TURCONA-Z

ceiling light; steel, aluminium, white / plastic, white
Deckenleuchte; Stahl, Alu, weiss / Kunststoff, weiss
plafonnier; acier, aluminium, blanc / plastique, blanc

H 75, Ø 600



34,2W



3980lm



Remote,
App



9 008606 221929

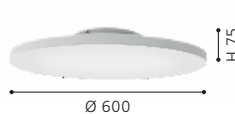

900055 TURCONA-Z

ceiling light; steel, aluminium, white / plastic, white
Deckenleuchte; Stahl, Alu, weiss / Kunststoff, weiss
plafonnier; acier, aluminium, blanc / plastique, blanc

H 75, Ø 450



22,4W



2490lm



Remote,
App



9 008606 221912





900055

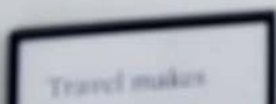



99548



99549



99548 HERRORA-Z

ceiling light; aluminium, white / plastic, white
Deckenleuchte; Alu, weiss / Kunststoff, weiss
plafonnier; aluminium, blanc / plastique, blanc

L 595, B 595, H 40



99549 HERRORA-Z

ceiling light; aluminium, white / plastic, white
Deckenleuchte; Alu, weiss / Kunststoff, weiss
plafonnier; aluminium, blanc / plastique, blanc

L 1200, B 300, H 40



99639 HERRORA-Z

ceiling light; aluminium, white / plastic, white
Deckenleuchte; Alu, weiss / Kunststoff, weiss
plafonnier; aluminium, blanc / plastique, blanc

L 450, B 450, H 40



9 002759 995485



9 002759 995492



9 002759 996390

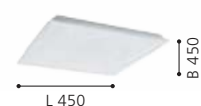



99639

LED



900057



900058



900059



TURCONA-Z

Frameless luminaire

Rahmenlose Leuchte

Luminaire sans cadre

900057 TURCONA-Z

ceiling light; steel, aluminium, white / plastic, white
Deckenleuchte; Stahl, Alu, weiss / Kunststoff, weiss
plafonnier; acier, aluminium, blanc / plastique, blanc

L 300, B 300, H 50



16W



1750lm



Remote,
App



900058 TURCONA-Z

ceiling light; steel, aluminium, white / plastic, white
Deckenleuchte; Stahl, Alu, weiss / Kunststoff, weiss
plafonnier; acier, aluminium, blanc / plastique, blanc

L 450, B 450, H 70



6x 3,8W



2400lm



Remote,
App



900059 TURCONA-Z

ceiling light; steel, aluminium, white / plastic, white
Deckenleuchte; Stahl, Alu, weiss / Kunststoff, weiss
plafonnier; acier, aluminium, blanc / plastique, blanc

L 600, B 600, H 75



6x 5,4W



4000lm



Remote,
App



9 008606 221936

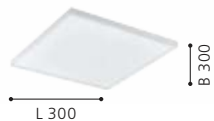

9 008606 221943

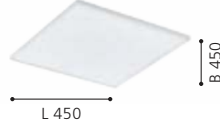

9 008606 221950

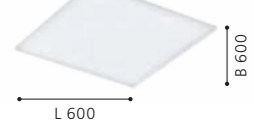



900062

LED



900061

LED

900062 TURCONA-Z

ceiling light; steel, aluminium, white / plastic, white
Deckenleuchte; Stahl, Alu, weiss / Kunststoff, weiss
plafonnier; acier, aluminium, blanc / plastique, blanc

L 1200, B 100, H 50

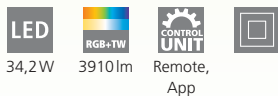

34,2W 3910lm Remote, App



9 008606 221974



900061 TURCONA-Z

ceiling light; steel, aluminium, white / plastic, white
Deckenleuchte; Stahl, Alu, weiss / Kunststoff, weiss
plafonnier; acier, aluminium, blanc / plastique, blanc

L 1200, B 300, H 50



3x 10,6W 4000lm Remote, App



9 008606 221967





900044



900045



900046



900044 SALOBRENA-Z

ceiling light; aluminium, white / plastic, white
Deckenleuchte; Alu, weiss / Kunststoff, weiss
plafonnier; aluminium, blanc / plastique, blanc

L 300, B 300, H 50



15,3W 1790lm Remote, App

900045 SALOBRENA-Z

ceiling light; aluminium, white / plastic, white
Deckenleuchte; Alu, weiss / Kunststoff, weiss
plafonnier; aluminium, blanc / plastique, blanc

L 450, B 450, H 50



21,5W 2500lm Remote, App

900046 SALOBRENA-Z

ceiling light; aluminium, white / plastic, white
Deckenleuchte; Alu, weiss / Kunststoff, weiss
plafonnier; aluminium, blanc / plastique, blanc

L 595, B 595, H 50



33W 4100lm Remote, App



9 008606 221813



9 008606 221820

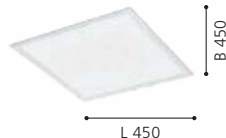

9 008606 221837





900047

LED



900048

LED



900047 SALOBRENA-Z

ceiling light; aluminium, white / plastic, white
Deckenleuchte; Alu, weiss / Kunststoff, weiss
plafonnier; aluminium, blanc / plastique, blanc

L 1200, B 300, H 50



33,5W 4150lm Remote, App



9 008606 221844



900048 SALOBRENA-Z

ceiling light; aluminium, white / plastic, white
Deckenleuchte; Alu, weiss / Kunststoff, weiss
plafonnier; aluminium, blanc / plastique, blanc

L 1200, B 100, H 45



33,5W 4150lm Remote, App



9 008606 221851

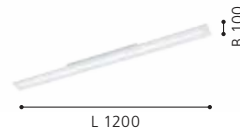

Zubehör inkludiert
Accessoires inclus



900049

LED



900051

LED



900052

LED

900049 SALOBRENA-Z

ceiling light; aluminium, black / plastic, white
Deckenleuchte; Alu, schwarz / Kunststoff, weiss
plafonnier; aluminium, noir / plastique, blanc

L 300, B 300, H 50

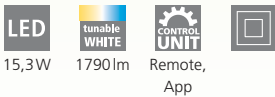

15,3W 1790lm Remote, App



9 008606 221868



900051 SALOBRENA-Z

ceiling light; aluminium, black / plastic, white
Deckenleuchte; Alu, schwarz / Kunststoff, weiss
plafonnier; aluminium, noir / plastique, blanc

L 450, B 450, H 50



21,5W 2500lm Remote, App



9 008606 221875



900052 SALOBRENA-Z

ceiling light; aluminium, black / plastic, white
Deckenleuchte; Alu, schwarz / Kunststoff, weiss
plafonnier; aluminium, noir / plastique, blanc

L 595, B 595, H 50

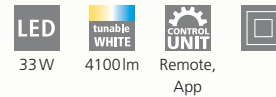

33W 4100lm Remote, App



9 008606 221882





900053



900095



900053 SALOBRENA-Z

ceiling light; aluminium, black / plastic, white
 Deckenleuchte; Alu, schwarz / Kunststoff, weiss
 plafonnier; aluminium, noir / plastique, blanc

L 1200, B 300, H 50



900095 SALOBRENA-Z

ceiling light; aluminium, steel, black / plastic, white
 Deckenleuchte; Alu, Stahl, schwarz / Kunststoff, weiss
 plafonnier; aluminium, acier, noir / plastique, blanc

L 1200, B 100, H 45

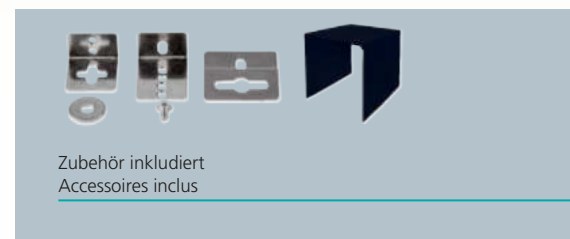
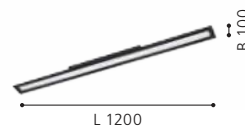

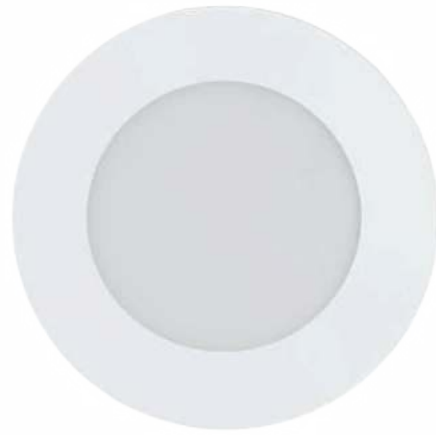

900099



900101



900102



900099 FUEVA-Z

recessed light; steel, white / plastic, white
Einbauleuchte; Stahl, weiss / Kunststoff, weiss
luminaire encastrable; acier, blanc / plastique, blanc

H 26, Ø 85



3x 2,8W 3x 390lm Remote, App Ø75 IP20, IP44



9 008606 225569



Ø 85

900101 FUEVA-Z

recessed light; steel, white / plastic, white
Einbauleuchte; Stahl, weiss / Kunststoff, weiss
luminaire encastrable; acier, blanc / plastique, blanc

H 26, Ø 120



5,4W 800lm Remote, App Ø105 IP20, IP44



9 008606 225576



Ø 120

900102 FUEVA-Z

recessed light; steel, white / plastic, white
Einbauleuchte; Stahl, weiss / Kunststoff, weiss
luminaire encastrable; acier, blanc / plastique, blanc

H 26, Ø 165



10,5W 1520lm Remote, App Ø155 IP20, IP44



9 008606 225583



Ø 165

98842

LED



98842 FUEVA-Z

recessed light; aluminium, white / plastic, white
Einbauleuchte; Alu, weiss / Kunststoff, weiss
luminaire encastrable; aluminium, blanc / plastique, blanc

Ø 216, ET 26



16,5W



2100lm



Remote,
App



Ø 205



IP20, IP44



9 002759 988425



Ø 216



900112



900111



900113



900111 FUEVA-Z

recessed light; steel, satin nickel / plastic, white
Einbauleuchte; Stahl, nickel-matt / Kunststoff, weiss
luminaire encastrable; acier, nickel mat / plastique, blanc

H 26, Ø 85



3x 2,8W



3x 390lm



Remote,
App



Ø 75



IP20, IP44



Ø 85

900112 FUEVA-Z

recessed light; steel, satin nickel / plastic, white
Einbauleuchte; Stahl, nickel-matt / Kunststoff, weiss
luminaire encastrable; acier, nickel mat / plastique, blanc

H 26, Ø 120



5,4W



800lm



Remote,
App



Ø 105



IP20, IP44



Ø 120

900113 FUEVA-Z

recessed light; steel, satin nickel / plastic, white
Einbauleuchte; Stahl, nickel-matt / Kunststoff, weiss
luminaire encastrable; acier, nickel mat / plastique, blanc

H 26, Ø 165



10,5W



1520lm



Remote,
App



Ø 155



IP20, IP44



Ø 165





98844

LED

98844 FUEVA-Z

recessed light; aluminium, satin nickel / plastic, white
 Einbauleuchte; Alu, nickel-matt / Kunststoff, weiss
 luminaire encastrable; aluminium, nickel mat / plastique, blanc

Ø 216, ET 26

-  LED
16,5W
-  tunable
WHITE
2100lm
-  CONTROL
UNIT
Remote,
App
-  Ø 205
-  IP20, IP44



Ø 216



900105



900106



98846



900105 FUEVA-Z

recessed light; steel, black / plastic, white
Einbauleuchte; Stahl, schwarz / Kunststoff, weiss
luminaire encastrable; acier, noir / plastique, blanc

H 26, Ø 85



3x 2,8W 3x 390lm Remote, App Ø75 IP20, IP44



Ø 85

900106 FUEVA-Z

recessed light; steel, black / plastic, white
Einbauleuchte; Stahl, schwarz / Kunststoff, weiss
luminaire encastrable; acier, noir / plastique, blanc

H 26, Ø 120



5,4W 800lm Remote, App Ø105 IP20, IP44



Ø 120

98846 FUEVA-Z

recessed light; aluminium, black / plastic, white
Einbauleuchte; Alu, schwarz / Kunststoff, weiss
luminaire encastrable; aluminium, noir / plastique, blanc

Ø 216, ET 26



16,5W 2100lm Remote, App Ø205 IP20, IP44



Ø 216



900107

LED

900107 FUEVA-Z

recessed light; steel, black / plastic, white
 Einbauleuchte; Stahl, schwarz / Kunststoff, weiss
 luminaire encastrable; acier, noir / plastique, blanc

H 26, Ø 165

-  LED
10,5W
-  tunable
WHITE
1520lm
-  CONTROL
UNIT
Remote,
App
-  Ø 155
-  IP20, IP44





900104

LED



900103

LED



98849

LED

900104 FUEVA-Z

surface-mounted light; steel, white / plastic, white
 Aufbauleuchte; Stahl, weiss / Kunststoff, weiss
 luminaire en saillie; acier, blanc / plastique, blanc

L 210, B 210, H 28



98849 FUEVA-Z

surface-mounted light; aluminium, white / plastic, white
 Aufbauleuchte; Alu, weiss / Kunststoff, weiss
 luminaire en saillie; aluminium, blanc / plastique, blanc

L 285, B 285, H 28

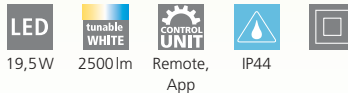

900103 FUEVA-Z

surface-mounted light; steel, white / plastic, white
 Aufbauleuchte; Stahl, weiss / Kunststoff, weiss
 luminaire en saillie; acier, blanc / plastique, blanc

H 28, Ø 210

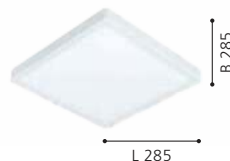
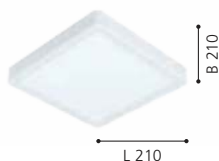
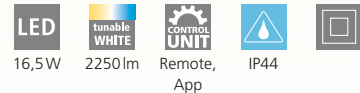



98843 FUEVA-Z

surface-mounted light; aluminium, white / plastic, white
Aufbauleuchte; Alu, weiss / Kunststoff, weiss
luminaire en saillie; aluminium, blanc / plastique, blanc

H 28, Ø 285

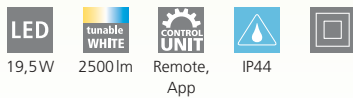

LED

19,5W

tunable
WHITE

2500lm

CONTROL
UNIT

Remote,
App

IP44



H 28

Ø 285



98843

LED



900114



900115



98845



900114 FUEVA-Z

surface-mounted light; steel, satin nickel / plastic, white
Aufbauleuchte; Stahl, nickel-matt / Kunststoff, weiss
luminaire en saillie; acier, nickel mat / plastique, blanc

H 28, Ø 210



16,5W



2250lm



Remote,
App



IP44



98845 FUEVA-Z

surface-mounted light; aluminium, satin nickel / plastic, white
Aufbauleuchte; Alu, nickel-matt / Kunststoff, weiss
luminaire en saillie; aluminium, nickel mat / plastique, blanc

H 28, Ø 285



19,5W



2500lm



Remote,
App



IP44



900115 FUEVA-Z

surface-mounted light; steel, satin nickel / plastic, white
Aufbauleuchte; Stahl, nickel-matt / Kunststoff, weiss
luminaire en saillie; acier, nickel mat / plastique, blanc

L 210, B 210, H 28



16,5W



2250lm



Remote,
App



IP44



9 008606 225699



9 002759 988456



9 008606 225705





98852 FUEVA-Z

surface-mounted light; aluminium, satin nickel / plastic, white
Aufbauleuchte; Alu, nickel-matt / Kunststoff, weiss
luminaire en saillie; aluminium, nickel mat / plastique, blanc

L 285, B 285, H 28



19,5W



2500lm



Remote,
App



IP44

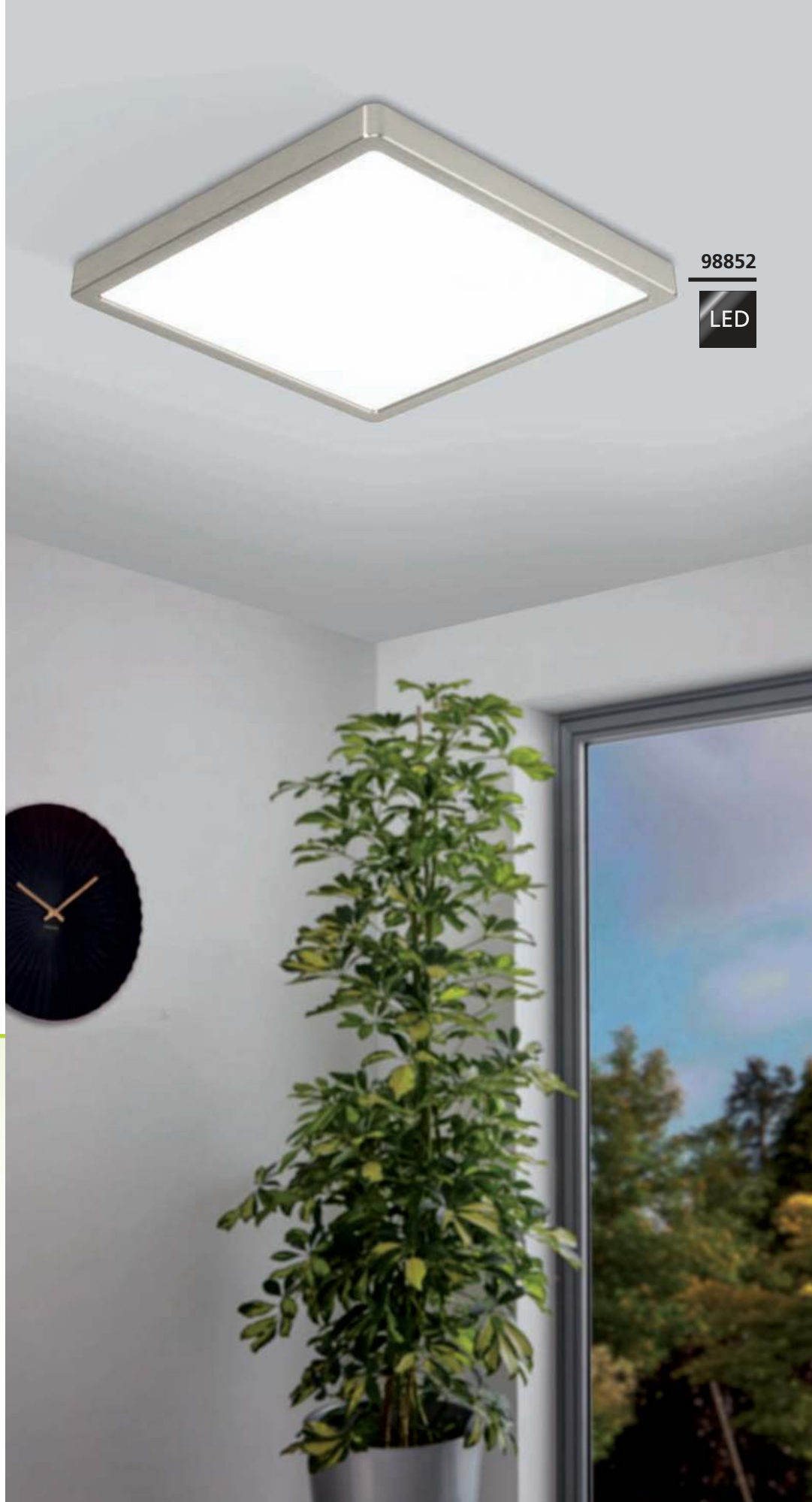

98852





900108

LED



98854

LED



98847

LED

900108 FUEVA-Z

surface-mounted light; steel, black / plastic, white
Aufbauleuchte; Stahl, schwarz / Kunststoff, weiss
luminaire en saillie; acier, noir / plastique, blanc

H 28, Ø 210



16,5W



2250lm



Remote,
App



IP44



98847 FUEVA-Z

surface-mounted light; aluminium, black / plastic, white
Aufbauleuchte; Alu, schwarz / Kunststoff, weiss
luminaire en saillie; aluminium, noir / plastique, blanc

H 28, Ø 285



19,5W



2500lm



Remote,
App



IP44



98854 FUEVA-Z

surface-mounted light; aluminium, black / plastic, white
Aufbauleuchte; Alu, schwarz / Kunststoff, weiss
luminaire en saillie; aluminium, noir / plastique, blanc

L 285, B 285, H 28



19,5W



2500lm



Remote,
App



IP44



9 008606 225644



Ø 210



9 002759 988470



Ø 285



9 002759 988548



L 285



900109

LED

900109 FUEVA-Z

surface-mounted light; steel, black / plastic, white
Aufbauleuchte; Stahl, schwarz / Kunststoff, weiss
luminaire en saillie; acier, noir / plastique, blanc

L 210, B 210, H 28



16,5W



2250lm



Remote,
App



IP44



9 008606 225651

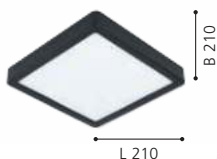



ROVITO-Z

These lights have individually controllable light settings on the inside and outside of the frame.

Diese Leuchten verfügen über individuell steuerbare Lichteinstellungen der Rahmen innen und außen.

Ces lumières ont des paramètres d'éclairage contrôlables individuellement du cadre.

900088 ROVITO-Z

ceiling light; plastic, white / plastic, white
Deckenleuchte; Kunststoff, weiss / Kunststoff, weiss
plafonnier; plastique, blanc / plastique, blanc

L 295, B 295, H 25

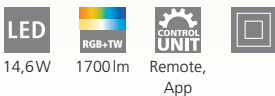

900089 ROVITO-Z

ceiling light; plastic, white / plastic, white
Deckenleuchte; Kunststoff, weiss / Kunststoff, weiss
plafonnier; plastique, blanc / plastique, blanc

L 420, B 420, H 25



900086 ROVITO-Z

ceiling light; plastic, white / plastic, white
Deckenleuchte; Kunststoff, weiss / Kunststoff, weiss
plafonnier; plastique, blanc / plastique, blanc

H 25, Ø 295

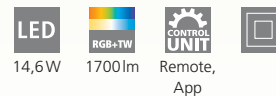



900087

LED

900087 ROVITO-Z

ceiling light; plastic, white / plastic, white

Deckenleuchte; Kunststoff, weiss / Kunststoff, weiss

plafonnier; plastique, blanc / plastique, blanc

H 25, Ø 420



16,5W



2200lm



Remote,
App



9 008606 225484





900093



900092



900094



ROVITO-Z

These lights have individually controllable light settings on the inside and outside of the frame.

Diese Leuchten verfügen über individuell steuerbare Lichteinstellungen der Rahmen innen und außen.

Ces lumières ont des paramètres d'éclairage contrôlables individuellement du cadre.

900093 ROVITO-Z

ceiling light; plastic, black / plastic, white
Deckenleuchte; Kunststoff, schwarz / Kunststoff, weiss
plafonnier; plastique, noir / plastique, blanc

L 295, B 295, H 25

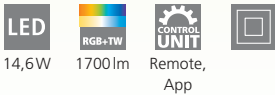

14,6W

1700lm

Remote,
App

900094 ROVITO-Z

ceiling light; plastic, black / plastic, white
Deckenleuchte; Kunststoff, schwarz / Kunststoff, weiss
plafonnier; plastique, noir / plastique, blanc

L 420, B 420, H 25

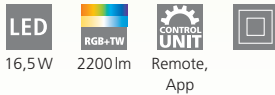

16,5W

2200lm

Remote,
App

900092 ROVITO-Z

ceiling light; plastic, black / plastic, white
Deckenleuchte; Kunststoff, schwarz / Kunststoff, weiss
plafonnier; plastique, noir / plastique, blanc

H 25, Ø 420

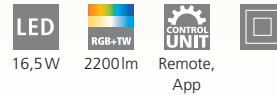

16,5W

2200lm

Remote,
App



9 008606 225538



9 008606 225545



9 008606 225521





900091



900091 ROVITO-Z

ceiling light; plastic, black / plastic, white

Deckenleuchte; Kunststoff, schwarz / Kunststoff, weiss

plafonnier; plastique, noir / plastique, blanc

H 25, Ø 295



14,6W



1700lm



Remote,
App



9 008606 225514





99686

99687



99684

99685



99684

Driver included

Treiber inkludiert

Chauffeur inclus



1x 1,5 m



99685

Extension for starter set 99684 without driver

Erweiterung für Starterset 99684 ohne Treiber

Rallonge pour kit de démarrage 99684 sans pilote

99686, 99687

Driver included

Treiber inkludiert

Chauffeur inclus



1x 1,5 m

99686 LED STRIPE-Z

bar / strip light; plastic, white
Leuchtband/-stab; Kunststoff, weiss
bande lumineuse / bâton l; plastique, blanc

L 5000, B 10

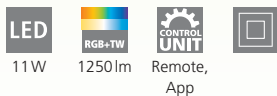

11W

1250lm

Remote, App

99687 LED STRIPE-Z

bar / strip light; plastic, white
Leuchtband/-stab; Kunststoff, weiss
bande lumineuse / bâton l; plastique, blanc

L 8000, B 12, H 3

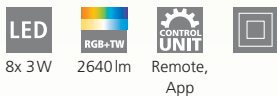

8x 3W

2640lm

Remote, App

99684 LED STRIPE-Z

bar / strip light; plastic, white
Leuchtband/-stab; Kunststoff, weiss
bande lumineuse / bâton l; plastique, blanc

L 3000, B 8



13,5W

1450lm

Remote, App



9 002759 996864



L 5000



9 002759 996871



L 8000



9 002759 996840



L 3000



99687



99685 LED STRIPE-Z

bar / strip light; plastic, white
 Leuchtband/-stab; Kunststoff, weiss
 bande lumineuse / bâton l; plastique, blanc

L 2000, B 8

9W
 950lm
 Remote, App

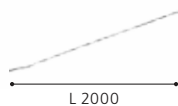



EGLO CONNECT.Z ILLUMINANT

One illuminant – numerous possibilities: 16.7 million colours and over 50,000 white tones ensure the right atmosphere in your home at all times. The illuminant can be controlled via remote control or app using Bluetooth technology: You can control the brightness or adjust colour tones – and all this without complicated installation and comfortably from the sofa.

But the illuminant can do much more: it can be expanded at will using intelligent mesh technology, and up to 50 illuminants can be grouped together. This makes it easy to create and program a wide variety of lighting scenarios. You can also use the app to select from a large number of pre-set lighting scenes.

Security is not neglected either, as the illuminants form a self-contained network and are therefore protected from external access.

EGLO CONNECT.Z LEUCHTMITTEL

Ein Leuchtmittel – zahlreiche Möglichkeiten: 16,7 Millionen Farben und über 50.000 Weißtöne sorgen jederzeit für die richtige Stimmung in Ihrem Heim. Über die Bluetooth-Technologie kann das Leuchtmittel per Fernbedienung oder App gesteuert werden: Sie können die Helligkeit kontrollieren oder Farbtöne einstellen – und das alles ohne aufwändige Installation und bequem vom Sofa aus.

Aber das Leuchtmittel kann noch viel mehr: es lässt sich per intelligenter Mesh-Technologie beliebig erweitern, bis zu 50 Leuchtmittel sind hierbei gruppierbar. So lassen sich problemlos und einfach unterschiedlichste Lichtszenarien erstellen und programmieren. Mit der App können Sie aber auch aus einer Vielzahl vorgegebener Lichtstimmungen auswählen.

Auch die Sicherheit kommt nicht zu kurz, denn die Leuchtmittel bilden ein in sich geschlossenes Netzwerk und sind somit vor Zugriffen von Außen geschützt.

AMPOULE EGLO CONNECT.Z

Une seule ampoule – de nombreuses possibilités : 16,7 millions de couleurs et plus de 50 000 tons de blanc assurent à tout moment la bonne ambiance dans votre maison. L'ampoule peut être commandée via une télécommande ou une appli, utilisant la technologie Bluetooth : Vous pouvez contrôler la luminosité ou régler les tons de couleurs – et tout cela sans installation compliquée et de manière confortablement depuis votre canapé.

Mais l'ampoule peut faire beaucoup plus : elle peut être étendue à volonté grâce à la technologie Mesh intelligentes, et jusqu'à 50 ampoules peuvent être regroupées. Il est ainsi facile de créer et de programmer une grande variété de scène lumineuse. Vous pouvez également utiliser l'appli pour sélectionner un grand nombre d'ambiance lumineuse prédéfinies.

La sécurité n'est pas négligée non plus, car les ampoules forment un réseau fermé et sont donc protégées des accès externes.

12253 E27-LED-A60

Dimensions Abmessungen / Dimensions	L 118, Ø 60
Socket Sockel / Douille	E27
Wattage Wattage / Puissance	9 W
Light Colour Lichtfarbe / Couleur lumineuse	2765 K
Operating voltage Betriebsspannung / Tension de fonctionnement	220-240V 50/60Hz
Lifetime Lebensdauer / Durée de vie	15000 h
Colour rendering index Farbwiedergabeindex / L'indice de restitution de couleurs	80



12254 E27-LED-G95

Dimensions Abmessungen / Dimensions	L 142, Ø 95
Socket Sockel / Douille	E27
Wattage Wattage / Puissance	13,5 W
Light Colour Lichtfarbe / Couleur lumineuse	2765 K
Operating voltage Betriebsspannung / Tension de fonctionnement	220-240V 50/60Hz
Lifetime Lebensdauer / Durée de vie	15000 h
Colour rendering index Farbwiedergabeindex / L'indice de restitution de couleurs	80



13,5 W

1300 lm
LUMEN



12252 E14-LED-P45

Dimensions Abmessungen / Dimensions	L 92, Ø 45
Socket Sockel / Douille	E14
Wattage Wattage / Puissance	4,9 W
Light Colour Lichtfarbe / Couleur lumineuse	2765 K
Operating voltage Betriebsspannung / Tension de fonctionnement	220-240V 50/60Hz
Lifetime Lebensdauer / Durée de vie	15000 h
Colour rendering index Farbwiedergabeindex / L'indice de restitution de couleurs	80



4,9 W

470 lm
LUMEN



12251 GU10-LED

Dimensions Abmessungen / Dimensions	L 59, Ø 50
Socket Sockel / Douille	GU10
Wattage Wattage / Puissance	4,9 W
Light Colour Lichtfarbe / Couleur lumineuse	2765 K
Operating voltage Betriebsspannung / Tension de fonctionnement	220-240V 50/60Hz
Lifetime Lebensdauer / Durée de vie	15000 h
Colour rendering index Farbwiedergabeindex / L'indice de restitution de couleurs	83
Beamangle Ausstrahlwinkel / Angle de rayonnement	45°



4,9 W

345 lm
LUMEN



12226 E27-LED-A60

Dimensions Abmessungen / Dimensions	L 105, Ø 60
Socket Sockel / Douille	E27
Wattage Wattage / Puissance	6 W
Light Colour Lichtfarbe / Couleur lumineuse	2700 K
Operating voltage Betriebsspannung / Tension de fonctionnement	220-240V 50/60Hz
Lifetime Lebensdauer / Durée de vie	15000 h
Colour rendering index Farbwiedergabeindex / L'indice de restitution de couleurs	80



6 W

806 lm
LUMEN

A+ E warm WHITE

6 W ~ 60 W

9 002759 122263

12227 E27-LED-ST64

Dimensions Abmessungen / Dimensions	L 142, Ø 64
Socket Sockel / Douille	E27
Wattage Wattage / Puissance	6 W
Light Colour Lichtfarbe / Couleur lumineuse	2700 K
Operating voltage Betriebsspannung / Tension de fonctionnement	220-240V 50/60Hz
Lifetime Lebensdauer / Durée de vie	15000 h
Colour rendering index Farbwiedergabeindex / L'indice de restitution de couleurs	80



6 W

806 lm
LUMEN

A+ E warm WHITE

6 W ~ 60 W

9 002759 122270

12228 E27-LED-G80

Dimensions Abmessungen / Dimensions	L 120, Ø 80
Socket Sockel / Douille	E27
Wattage Wattage / Puissance	6 W
Light Colour Lichtfarbe / Couleur lumineuse	2700 K
Operating voltage Betriebsspannung / Tension de fonctionnement	220-240V 50/60Hz
Lifetime Lebensdauer / Durée de vie	15000 h
Colour rendering index Farbwiedergabeindex / L'indice de restitution de couleurs	80



6 W

806 lm
LUMEN

A+ E warm WHITE

6 W ~ 60 W

9 002759 122287

12229 E27-LED-G95

Dimensions Abmessungen / Dimensions	L 140, Ø 95
Socket Sockel / Douille	E27
Wattage Wattage / Puissance	6 W
Light Colour Lichtfarbe / Couleur lumineuse	2700 K
Operating voltage Betriebsspannung / Tension de fonctionnement	220-240V 50/60Hz
Lifetime Lebensdauer / Durée de vie	15000 h
Colour rendering index Farbwiedergabeindex / L'indice de restitution de couleurs	80



6 W

806 lm
LUMEN

A E warm WHITE

6 W 60W

9 002759 122294

12231 E27-LED-A60

Dimensions Abmessungen / Dimensions	L 105, Ø 60
Socket Sockel / Douille	E27
Wattage Wattage / Puissance	6 W
Light Colour Lichtfarbe / Couleur lumineuse	4000 K
Operating voltage Betriebsspannung / Tension de fonctionnement	220-240V 50/60Hz
Lifetime Lebensdauer / Durée de vie	15000 h
Colour rendering index Farbwiedergabeindex / L'indice de restitution de couleurs	80



6 W

806 lm
LUMEN

A E neutral WHITE

6 W 60W

9 002759 122317

12232 E27-LED-ST64

Dimensions Abmessungen / Dimensions	L 142, Ø 64
Socket Sockel / Douille	E27
Wattage Wattage / Puissance	6 W
Light Colour Lichtfarbe / Couleur lumineuse	4000 K
Operating voltage Betriebsspannung / Tension de fonctionnement	220-240V 50/60Hz
Lifetime Lebensdauer / Durée de vie	15000 h
Colour rendering index Farbwiedergabeindex / L'indice de restitution de couleurs	80



6 W

806 lm
LUMEN

A E neutral WHITE

6 W 60W

9 002759 122324

12233 E27-LED-G80

Dimensions Abmessungen / Dimensions	L 120, Ø 80
Socket Socket / Douille	E27
Wattage Wattage / Puissance	6 W
Light Colour Lichtfarbe / Couleur lumineuse	4000 K
Operating voltage Betriebsspannung / Tension de fonctionnement	220-240V 50/60Hz
Lifetime Lebensdauer / Durée de vie	15000 h
Colour rendering index Farbwiedergabeindex / L'indice de restitution de couleurs	80



6 W
806 lm
LUMEN



12234 E27-LED-G95

Dimensions Abmessungen / Dimensions	L 140, Ø 95
Socket Socket / Douille	E27
Wattage Wattage / Puissance	6 W
Light Colour Lichtfarbe / Couleur lumineuse	4000 K
Operating voltage Betriebsspannung / Tension de fonctionnement	220-240V 50/60Hz
Lifetime Lebensdauer / Durée de vie	15000 h
Colour rendering index Farbwiedergabeindex / L'indice de restitution de couleurs	80



6 W
806 lm
LUMEN



12235 E27-LED-A60

Dimensions Abmessungen / Dimensions	L 105, Ø 60
Socket Socket / Douille	E27
Wattage Wattage / Puissance	6 W
Light Colour Lichtfarbe / Couleur lumineuse	2265 K
Operating voltage Betriebsspannung / Tension de fonctionnement	220-240V 50/60Hz
Lifetime Lebensdauer / Durée de vie	15000 h
Colour rendering index Farbwiedergabeindex / L'indice de restitution de couleurs	80



6 W
806 lm
LUMEN



12236 E27-LED-ST64

Dimensions Abmessungen / Dimensions	L 142, Ø 64
Socket Sockel / Douille	E27
Wattage Wattage / Puissance	6 W
Light Colour Lichtfarbe / Couleur lumineuse	2265 K
Operating voltage Betriebsspannung / Tension de fonctionnement	220-240V 50/60Hz
Lifetime Lebensdauer / Durée de vie	15000 h
Colour rendering index Farbwiedergabeindex / L'indice de restitution de couleurs	80



6 W

806 lm
LUMEN



12237 E27-LED-G80

Dimensions Abmessungen / Dimensions	L 120, Ø 80
Socket Sockel / Douille	E27
Wattage Wattage / Puissance	6 W
Light Colour Lichtfarbe / Couleur lumineuse	2265 K
Operating voltage Betriebsspannung / Tension de fonctionnement	220-240V 50/60Hz
Lifetime Lebensdauer / Durée de vie	15000 h
Colour rendering index Farbwiedergabeindex / L'indice de restitution de couleurs	80



6 W

806 lm
LUMEN



12239 E27-LED-G95

Dimensions Abmessungen / Dimensions	L 140, Ø 95
Socket Sockel / Douille	E27
Wattage Wattage / Puissance	6 W
Light Colour Lichtfarbe / Couleur lumineuse	2265 K
Operating voltage Betriebsspannung / Tension de fonctionnement	220-240V 50/60Hz
Lifetime Lebensdauer / Durée de vie	15000 h
Colour rendering index Farbwiedergabeindex / L'indice de restitution de couleurs	80



6 W

806 lm
LUMEN



12221 E27-LED-A60

Dimensions Abmessungen / Dimensions	L 105, Ø 60
Socket Sockel / Douille	E27
Wattage Wattage / Puissance	4,9 W
Light Colour Lichtfarbe / Couleur lumineuse	2200 K
Operating voltage Betriebsspannung / Tension de fonctionnement	220-240V 50/60Hz
Lifetime Lebensdauer / Durée de vie	15000 h
Colour rendering index Farbwiedergabeindex / L'indice de restitution de couleurs	80



4,9 W

500 lm
LUMEN

AG F warm WHITE

4,9 W ~ 41 W



9 002759 122218

12222 E27-LED-ST64

Dimensions Abmessungen / Dimensions	L 142, Ø 64
Socket Sockel / Douille	E27
Wattage Wattage / Puissance	4,9 W
Light Colour Lichtfarbe / Couleur lumineuse	2200 K
Operating voltage Betriebsspannung / Tension de fonctionnement	220-240V 50/60Hz
Lifetime Lebensdauer / Durée de vie	15000 h
Colour rendering index Farbwiedergabeindex / L'indice de restitution de couleurs	80



4,9 W

500 lm
LUMEN

AG F warm WHITE

4,9 W ~ 41 W



9 002759 122225

12223 E27-LED-G80

Dimensions Abmessungen / Dimensions	L 120, Ø 80
Socket Sockel / Douille	E27
Wattage Wattage / Puissance	4,9 W
Light Colour Lichtfarbe / Couleur lumineuse	2200 K
Operating voltage Betriebsspannung / Tension de fonctionnement	220-240V 50/60Hz
Lifetime Lebensdauer / Durée de vie	15000 h
Colour rendering index Farbwiedergabeindex / L'indice de restitution de couleurs	80



4,9 W

500 lm
LUMEN

AG F warm WHITE

4,9 W ~ 41 W



9 002759 122232

12224 E27-LED-G95

Dimensions Abmessungen / Dimensions	L 140, Ø 95
Socket Sockel / Douille	E27
Wattage Wattage / Puissance	4,9 W
Light Colour Lichtfarbe / Couleur lumineuse	2200 K
Operating voltage Betriebsspannung / Tension de fonctionnement	220-240V 50/60Hz
Lifetime Lebensdauer / Durée de vie	15000 h
Colour rendering index Farbwiedergabeindex / L'indice de restitution de couleurs	80



4,9 W

500 lm
LUMEN



4,9 W



41 W



12225 E27-LED-G125

Dimensions Abmessungen / Dimensions	L 172, Ø 125
Socket Sockel / Douille	E27
Wattage Wattage / Puissance	6 W
Light Colour Lichtfarbe / Couleur lumineuse	2200 K
Operating voltage Betriebsspannung / Tension de fonctionnement	220-240V 50/60Hz
Lifetime Lebensdauer / Durée de vie	15000 h
Colour rendering index Farbwiedergabeindex / L'indice de restitution de couleurs	80



6 W

650 lm
LUMEN



6 W



50 W



12241 E27-LED-A60

Dimensions Abmessungen / Dimensions	L 105, Ø 60
Socket Sockel / Douille	E27
Wattage Wattage / Puissance	4,9 W
Light Colour Lichtfarbe / Couleur lumineuse	2265 K
Operating voltage Betriebsspannung / Tension de fonctionnement	220-240V 50/60Hz
Lifetime Lebensdauer / Durée de vie	15000 h
Colour rendering index Farbwiedergabeindex / L'indice de restitution de couleurs	80



4,9 W
360 lm
LUMEN



12242 E27-LED-ST64

Dimensions Abmessungen / Dimensions	L 142, Ø 64
Socket Sockel / Douille	E27
Wattage Wattage / Puissance	4,9 W
Light Colour Lichtfarbe / Couleur lumineuse	2265 K
Operating voltage Betriebsspannung / Tension de fonctionnement	220-240V 50/60Hz
Lifetime Lebensdauer / Durée de vie	15000 h
Colour rendering index Farbwiedergabeindex / L'indice de restitution de couleurs	80



4,9 W
360 lm
LUMEN



12243 E27-LED-G80

Dimensions Abmessungen / Dimensions	L 120, Ø 80
Socket Sockel / Douille	E27
Wattage Wattage / Puissance	4,9 W
Light Colour Lichtfarbe / Couleur lumineuse	2265 K
Operating voltage Betriebsspannung / Tension de fonctionnement	220-240V 50/60Hz
Lifetime Lebensdauer / Durée de vie	15000 h
Colour rendering index Farbwiedergabeindex / L'indice de restitution de couleurs	80



4,9 W
360 lm
LUMEN



12244 E27-LED-G95

Dimensions Abmessungen / Dimensions	L 140, Ø 95
Socket Sockel / Douille	E27
Wattage Wattage / Puissance	4,9 W
Light Colour Lichtfarbe / Couleur lumineuse	2265 K
Operating voltage Betriebsspannung / Tension de fonctionnement	220-240V 50/60Hz
Lifetime Lebensdauer / Durée de vie	15000 h
Colour rendering index Farbwiedergabeindex / L'indice de restitution de couleurs	80



12245 E27-LED-G125

Dimensions Abmessungen / Dimensions	L 170, Ø 125
Socket Sockel / Douille	E27
Wattage Wattage / Puissance	4,9 W
Light Colour Lichtfarbe / Couleur lumineuse	2265 K
Operating voltage Betriebsspannung / Tension de fonctionnement	220-240V 50/60Hz
Lifetime Lebensdauer / Durée de vie	15000 h
Colour rendering index Farbwiedergabeindex / L'indice de restitution de couleurs	80



12255 E27-LED-A60

Dimensions Abmessungen / Dimensions	L 105, Ø 60
Socket Sockel / Douille	E27
Wattage Wattage / Puissance	6 W
Light Colour Lichtfarbe / Couleur lumineuse	4000 K
Operating voltage Betriebsspannung / Tension de fonctionnement	220-240V 50/60Hz
Lifetime Lebensdauer / Durée de vie	15000 h
Colour rendering index Farbwiedergabeindex / L'indice de restitution de couleurs	80



incl./inkl./inclus



6 W
806 lm
LUMEN



12256 E27-LED-ST64

Dimensions Abmessungen / Dimensions	L 142, Ø 64
Socket Sockel / Douille	E27
Wattage Wattage / Puissance	4,9 W
Light Colour Lichtfarbe / Couleur lumineuse	2200 K
Operating voltage Betriebsspannung / Tension de fonctionnement	220-240V 50/60Hz
Lifetime Lebensdauer / Durée de vie	15000 h
Colour rendering index Farbwiedergabeindex / L'indice de restitution de couleurs	80



incl./inkl./inclus



4,9 W
500 lm
LUMEN



12257 E27-LED-A60

Dimensions Abmessungen / Dimensions	L 105, Ø 60
Socket Sockel / Douille	E27
Wattage Wattage / Puissance	6 W
Light Colour Lichtfarbe / Couleur lumineuse	4000 K
Operating voltage Betriebsspannung / Tension de fonctionnement	220-240V 50/60Hz
Lifetime Lebensdauer / Durée de vie	15000 h
Colour rendering index Farbwiedergabeindex / L'indice de restitution de couleurs	80



incl./inkl./inclus



6 W
806 lm
LUMEN



12258 E27-LED-ST64

Dimensions Abmessungen / Dimensions	L 142, Ø 64
Socket Sockel / Douille	E27
Wattage Wattage / Puissance	4,9 W
Light Colour Lichtfarbe / Couleur lumineuse	2200 K
Operating voltage Betriebsspannung / Tension de fonctionnement	220-240V 50/60Hz
Lifetime Lebensdauer / Durée de vie	15000 h
Colour rendering index Farbwiedergabeindex / L'indice de restitution de couleurs	80



incl./inkl./inclus

4,9 W

500 lm
LUMEN



warm
WHITE



4,9 W



41 W



EGLO Access

Let **light** follow
your **life**



OVERVIEW

EGLO ACCESS



ACCESS REMOTE
p. 102



ZUBIETA-A
p. 102-104



SILERAS-A
p. 105



FRANIA-A
p. 106-107



MORATICA-A
p. 107



SARSINA-A
p. 108



SALOBRENA-A
p. 110-111



FUEVA-A
p. 112



This product is available in different colors and shapes./ Dieser Artikel ist in unterschiedlichen Farben und Formen verfügbar.
Cet article est disponible en différentes couleurs et formes.

FUNCTIONS

FUNKTIONEN FONCTIONS

Relax with warm light and leave the hustle and bustle of everyday life behind you. Concentrate on your work or dispel fatigue, with neutral white light the energy level is replenished. EGLO Access offers these possibilities and many more. All functions and highlights at a glance:

- › It works with radio frequency technology and allows 360 degree control
- › Controllable up to a distance of 10 meters
- › Up to 8 different items can be connected
- › Easy handling thanks to 4 ready-made settings and 2 memory functions

NIGHT LIGHT

RELAX MODE

WORK MODE

SWITCH OFF AFTER 30 MINUTES

Mit warmem Licht entspannen und die Hektik des Alltages hinter sich lassen. Konzentriert arbeiten oder die Müdigkeit vertreiben, mit neutralweißem Licht wird das Energielevel wieder aufgefüllt. Diese Möglichkeiten und noch viele mehr bietet Ihnen EGLO Access. Alle Funktionen und Highlights auf einem Blick:

- › Es arbeitet mit Funktechnologie und ermöglicht eine 360-Grad-Steuerung
- › Steuerbar bis zu einer Entfernung von 10 Metern
- › Bis zu 8 verschiedene Artikel können miteinander verbunden werden
- › Einfache Handhabung durch 4 vorgefertigte Einstellungen und 2 Speicherfunktionen

NACHTLICHT

ENTSPANNUNGSMODUS

ARBEITSMODUS

AUSSCHALTEN NACH 30 MINUTEN

Lumière chaude pour se détendre et laisser l'agitation quotidienne derrière soi. Travailler de manière concentrée ou chasser la fatigue, avec une lumière blanche neutre, le niveau d'énergie est rétabli. EGLO Access vous offre ces possibilités et bien d'autres encore. Toutes les fonctions et les points forts en un coup d'œil :

- › Il fonctionne avec la technologie de la fréquence radio et permet un contrôle à 360 degrés
- › Contrôlable jusqu'à une distance de 10 mètres
- › Jusqu'à 8 articles différents peuvent être connectés ensemble
- › Manipulation facile grâce à 4 réglages prêts à l'emploi et 2 fonctions mémoire

VEILLEUSE

MODE DE DÉCOMPRESSION

MODE DE TRAVAIL

EXTINCTION APRÈS 30 MINUTES

COLOUR TEMPERATURES SCALE / FARBTEMPERATUREN SKALA / ÉCHELLE DES TEMPÉRATURES DE COULEUR



REMOTE CONTROL

FERNBEDIENUNG
TÉLÉCOMMANDE

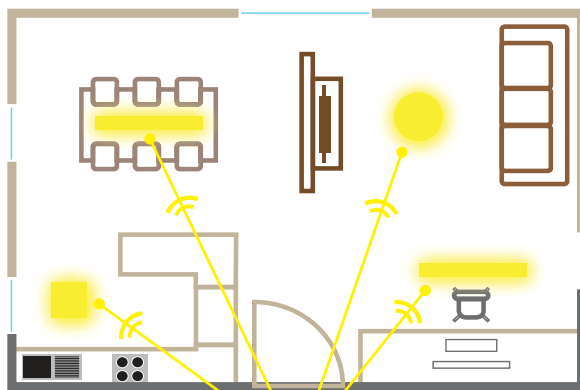

no internet necessary
kein Internet erforderlich
nul besoin d'internet



Control up to 8 EGLO Access luminaires
Bis zu 8 EGLO Access Leuchten steuerbar
Contrôle jusqu'à 8 luminaires EGLO Access



98894

LED

incl./inkl./inclus



33199



incl./inkl./inclus

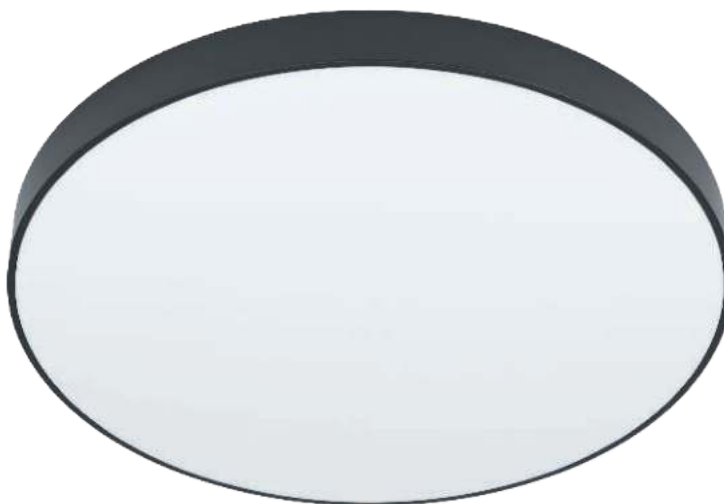

98895

LED

incl./inkl./inclus



33199 ACCESS REMOTE

remote control; plastic, anthracite
Fernbedienung; Kunststoff, anthrazit
Télécommande; plastique, gris anthracite

L 118, B 45



ACCU
CR2032

98894 ZUBIETA-A

surface-mounted light; steel, black / plastic, white
Aufbauleuchte; Stahl, schwarz / Kunststoff, weiss
luminaire en saillie; acier, noir / plastique, blanc

H 40, Ø 300



18W



1900lm



Remote

98895 ZUBIETA-A

surface-mounted light; steel, black / plastic, white
Aufbauleuchte; Stahl, schwarz / Kunststoff, weiss
luminaire en saillie; acier, noir / plastique, blanc

H 40, Ø 450



24W



2300lm



Remote



9 002759 331993



B 45



9 002759 988944



SURFACE



Ø 300



9 002759 988951



SURFACE



Ø 450



98896

LED

incl./inkl./inclus



98896 ZUBIETA-A

surface-mounted light; steel, black / plastic, white
Aufbauleuchte; Stahl, schwarz / Kunststoff, weiss
luminaire en saillie; acier, noir / plastique, blanc

H 40, Ø 595

LED

36W

tunable
WHITE

3700lm



CONTROL
UNIT

Remote

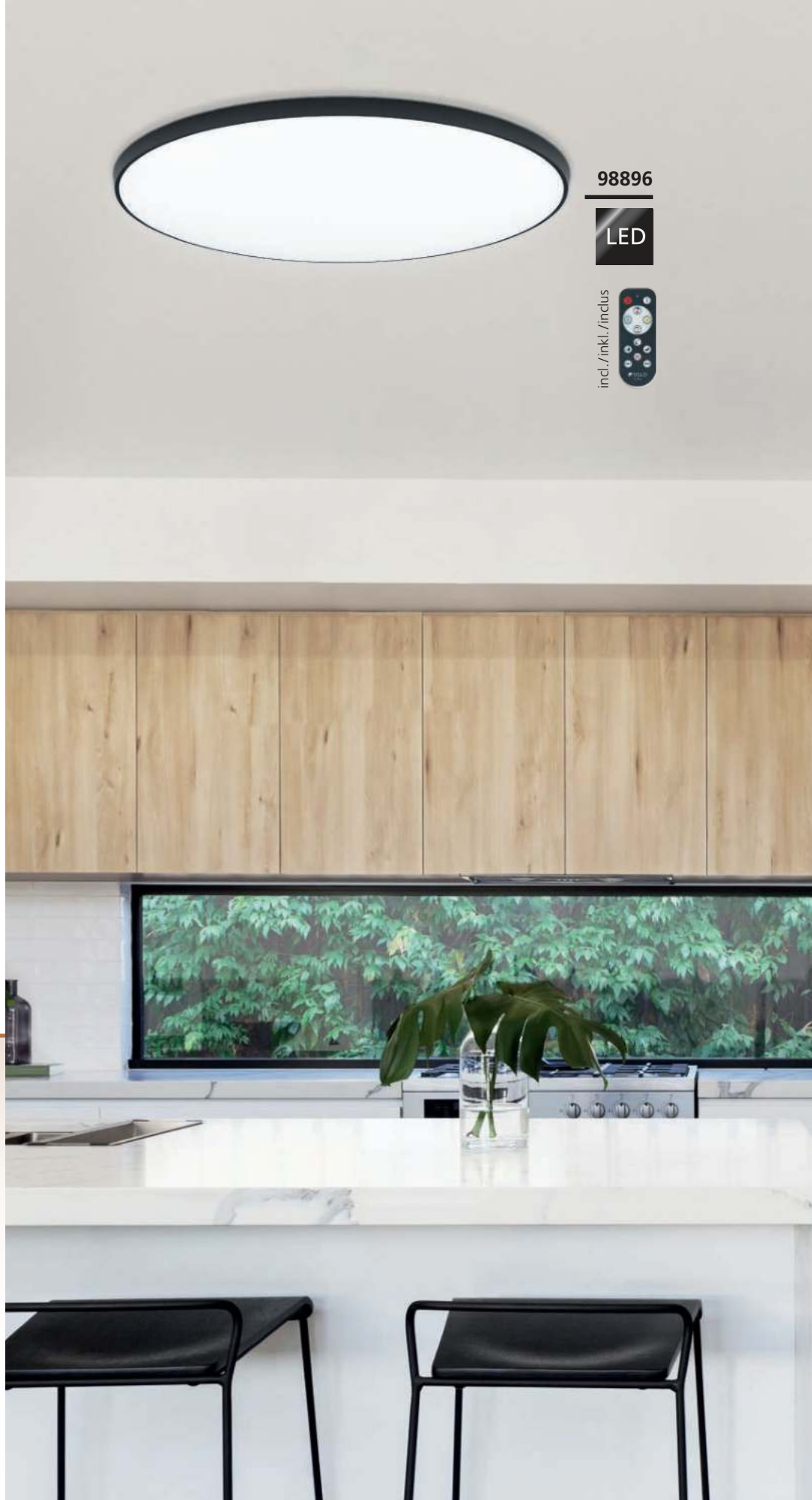



98892



98891



98893



98891 ZUBIETA-A

surface-mounted light; steel, white / plastic, white
Aufbauleuchte; Stahl, weiss / Kunststoff, weiss
luminaire en saillie; acier, blanc / plastique, blanc

H 40, Ø 300



18W



1900lm



Remote

98892 ZUBIETA-A

surface-mounted light; steel, white / plastic, white
Aufbauleuchte; Stahl, weiss / Kunststoff, weiss
luminaire en saillie; acier, blanc / plastique, blanc

H 40, Ø 450



24W



2300lm



Remote

98893 ZUBIETA-A

surface-mounted light; steel, white / plastic, white
Aufbauleuchte; Stahl, weiss / Kunststoff, weiss
luminaire en saillie; acier, blanc / plastique, blanc

H 40, Ø 595



36W



3700lm



Remote



9 002759 988913



9 002759 988920



9 002759 988937





98227



98228

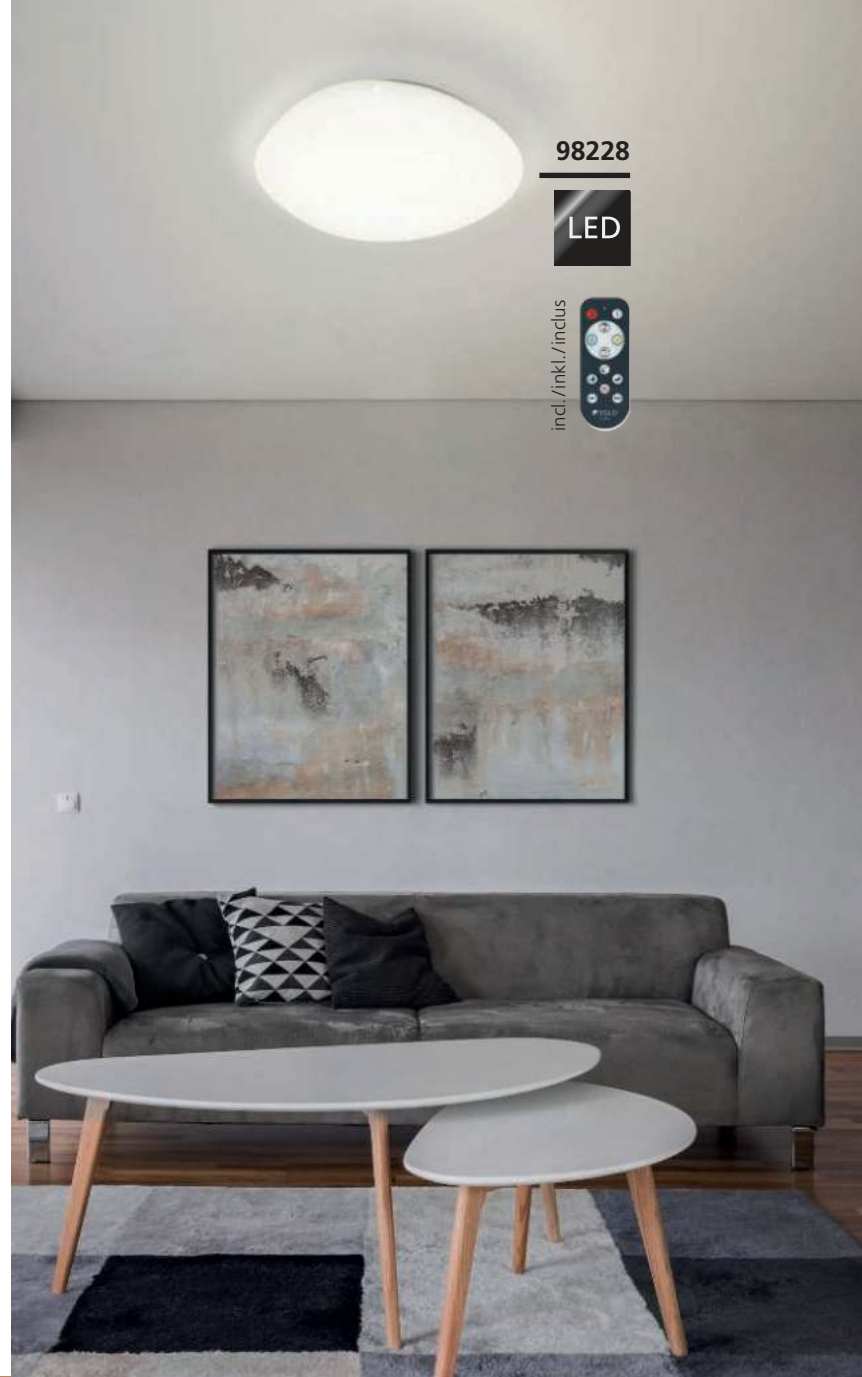

98227 SILERAS-A

wall / ceiling light; steel, white / plastic with crystal effect, white
 Wand- / Deckenleuchte; Stahl, weiss / Kunststoff m.Kristalleffekt, weiss
 applique / plafonnier; acier, blanc / plastique avec effet cristal, blanc

H 80, Ø 450



98228 SILERAS-A

wall / ceiling light; steel, white / plastic with crystal effect, white
 Wand- / Deckenleuchte; Stahl, weiss / Kunststoff m.Kristalleffekt, weiss
 applique / plafonnier; acier, blanc / plastique avec effet cristal, blanc

H 85, Ø 600





98294

LED

incl./inkl./inclus



98236

LED

incl./inkl./inclus



98237

LED

incl./inkl./inclus



98294 FRANIA-A

wall / ceiling light; steel, white / plastic with crystal effect, white
Wand- / Deckenleuchte; Stahl, weiss / Kunststoff m.Kristalleffekt, weiss
applique / plafonnier; acier, blanc / plastique avec effet cristal, blanc

H 55, Ø 300

LED

12 W

tunable
WHITE

1050 lm



CONTROL
UNIT

Remote



IP44

98236 FRANIA-A

wall / ceiling light; steel, white / plastic with crystal effect, white
Wand- / Deckenleuchte; Stahl, weiss / Kunststoff m.Kristalleffekt, weiss
applique / plafonnier; acier, blanc / plastique avec effet cristal, blanc

H 55, Ø 400

LED

19 W

tunable
WHITE

2400 lm



CONTROL
UNIT

Remote

98237 FRANIA-A

wall / ceiling light; steel, white / plastic with crystal effect, white
Wand- / Deckenleuchte; Stahl, weiss / Kunststoff m.Kristalleffekt, weiss
applique / plafonnier; acier, blanc / plastique avec effet cristal, blanc

H 75, Ø 570

LED

32,5 W

tunable
WHITE

3900 lm



CONTROL
UNIT

Remote



9 002759 982942



Ø 300



9 002759 982362



Ø 400



9 002759 982379



Ø 570



98219

LED



incl./inkl./inclus



98235

LED



incl./inkl./inclus



98235 FRANIA-A

wall / ceiling light; steel, white / plastic, white
Wand- / Deckenleuchte; Stahl, weiss / Kunststoff, weiss
applique / plafonnier; acier, blanc / plastique, blanc

H 55, Ø 300



12W

1050lm

Remote

98219 MORATICA-A

ceiling light; steel, plastic, white, transparent / plastic with
crystal effect, white, silver
Deckenleuchte; Stahl, Kunststoff, weiss, transparent / Kunststoff
m. Kristalleffekt, weiss, silber
plafonnier; acier, plastique, blanc, transparent / plastique avec
effet cristal, blanc, argent
H 75, Ø 570



32,5W

3900lm

Remote



9 002759 982355



9 002759 982195





98207



98208



98207 SARSINA-A

ceiling light; aluminium, white / plastic, white
Deckenleuchte; Alu, weiss / Kunststoff, weiss
plafonnier; aluminium, blanc / plastique, blanc

H 50, Ø 300



14W



2000lm



Remote



98208 SARSINA-A

ceiling light; aluminium, white / plastic, white
Deckenleuchte; Alu, weiss / Kunststoff, weiss
plafonnier; aluminium, blanc / plastique, blanc

H 50, Ø 450



19,5W



2750lm



Remote



98209 SARSINA-A

ceiling light; aluminium, white / plastic, white
Deckenleuchte; Alu, weiss / Kunststoff, weiss
plafonnier; aluminium, blanc / plastique, blanc

H 50, Ø 600



30W



4000lm



Remote



9 002759 982072

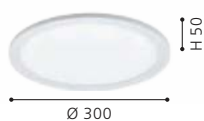

9 002759 982089

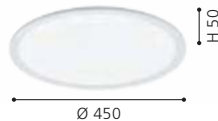

9 002759 982096

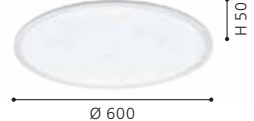



98209

LED

incl./inkl./inclus





98205

LED



incl./inkl./inclus



98206

LED



incl./inkl./inclus



98205 SALOBRENA-A

ceiling light; aluminium, white / plastic, white
Deckenleuchte; Alu, weiss / Kunststoff, weiss
plafonnier; aluminium, blanc / plastique, blanc

L 1200, B 300, H 50



30W



3900lm



Remote



98206 SALOBRENA-A

ceiling light; aluminium, white / plastic, white
Deckenleuchte; Alu, weiss / Kunststoff, weiss
plafonnier; aluminium, blanc / plastique, blanc

L 1195, B 100, H 50



30W



3900lm



Remote



98297 SALOBRENA-A

ceiling light; aluminium, white / plastic, white
Deckenleuchte; Alu, weiss / Kunststoff, weiss
plafonnier; aluminium, blanc / plastique, blanc

L 450, B 450, H 50



20W



2600lm



Remote



9 002759 982058



9 002759 982065



9 002759 982973

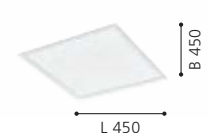



98297



98201



98203



98201 SALOBRENA-A

ceiling light; aluminium, white / plastic, white
Deckenleuchte; Alu, weiss / Kunststoff, weiss
plafonnier; aluminium, blanc / plastique, blanc

L 300, B 300, H 50



98203 SALOBRENA-A

ceiling light; aluminium, white / plastic, white
Deckenleuchte; Alu, weiss / Kunststoff, weiss
plafonnier; aluminium, blanc / plastique, blanc

L 600, B 600, H 50



9 002759 982010

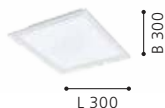

9 002759 982034

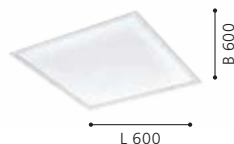



98292



FUEVA-A

These luminaires inspire with their extremely flat and elegant design.

Diese Leuchten begeistern durch ihre extrem flache und elegante Bauweise.

Ces lumières enthousiasment par la méthode de construction extrêmement plate et élégante.



98293



98292 FUEVA-A

surface-mounted light; aluminium, white / plastic, white
 Aufbauleuchte; Alu, weiss / Kunststoff, weiss
 luminaire en saillie; aluminium, blanc / plastique, blanc

H 30, Ø 225



98293 FUEVA-A

surface-mounted light; aluminium, white / plastic, white
 Aufbauleuchte; Alu, weiss / Kunststoff, weiss
 luminaire en saillie; aluminium, blanc / plastique, blanc

H 30, Ø 300



98212 FUEVA-A

recessed light; aluminium, white / plastic, white
 Einbauleuchte; Alu, weiss / Kunststoff, weiss
 luminaire encastrable; aluminium, blanc / plastique, blanc

Ø 120, ET 30





98212

LED

incl./inkl./inclus



LIGHTING FAMILIES

FABRIC LUMINAIRES

STOFFLEUCHTEN

LUMINAIRES À TEXTIL

SIMPLE CLASSINESS

The textile luminaires with their unusual designs are perfectly trendy and bring cosiness to every home. Selected textiles in natural shades and clear shapes form the basis of a friendly and tasteful living environment in our textile luminaires. Inner coatings in sophisticated gold and classical silver add an air of luxury.

SCHLICHTE ELEGANZ

Die Stoffleuchten mit ihrem außergewöhnlichen Design sind voll im Trend und sorgen für Gemütlichkeit in jedem Zuhause. Bei den Stoffleuchten bilden ausgesuchte Stoffe in Naturtönen und klare Formgebungen die Grundlage für eine freundliche und geschmackvolle Wohnumgebung. Für einen Hauch von Luxus sorgen die Innenbeschichtungen in edlem Gold und klassischem Silber.



ÉLÉGANCE SIMPLE

Les luminaires en étoffe avec leur design extraordinaire sont très tendance et assurent un confort dans chaque maison. Chez les luminaires en étoffe, des étoffes sélectionnées dans des tons naturels et des formes claires forment la base d'un cadre de vie convivial et de bon goût. Les revêtements internes en or fin et en argent classique ajoutent une touche de luxe.



OVERVIEW

LIGHTING FAMILIES / FABRIC



This product is available in different colors and shapes./ Dieser Artikel ist in unterschiedlichen Farben und Formen verfügbar.
Cet article est disponible en différentes couleurs et formes.



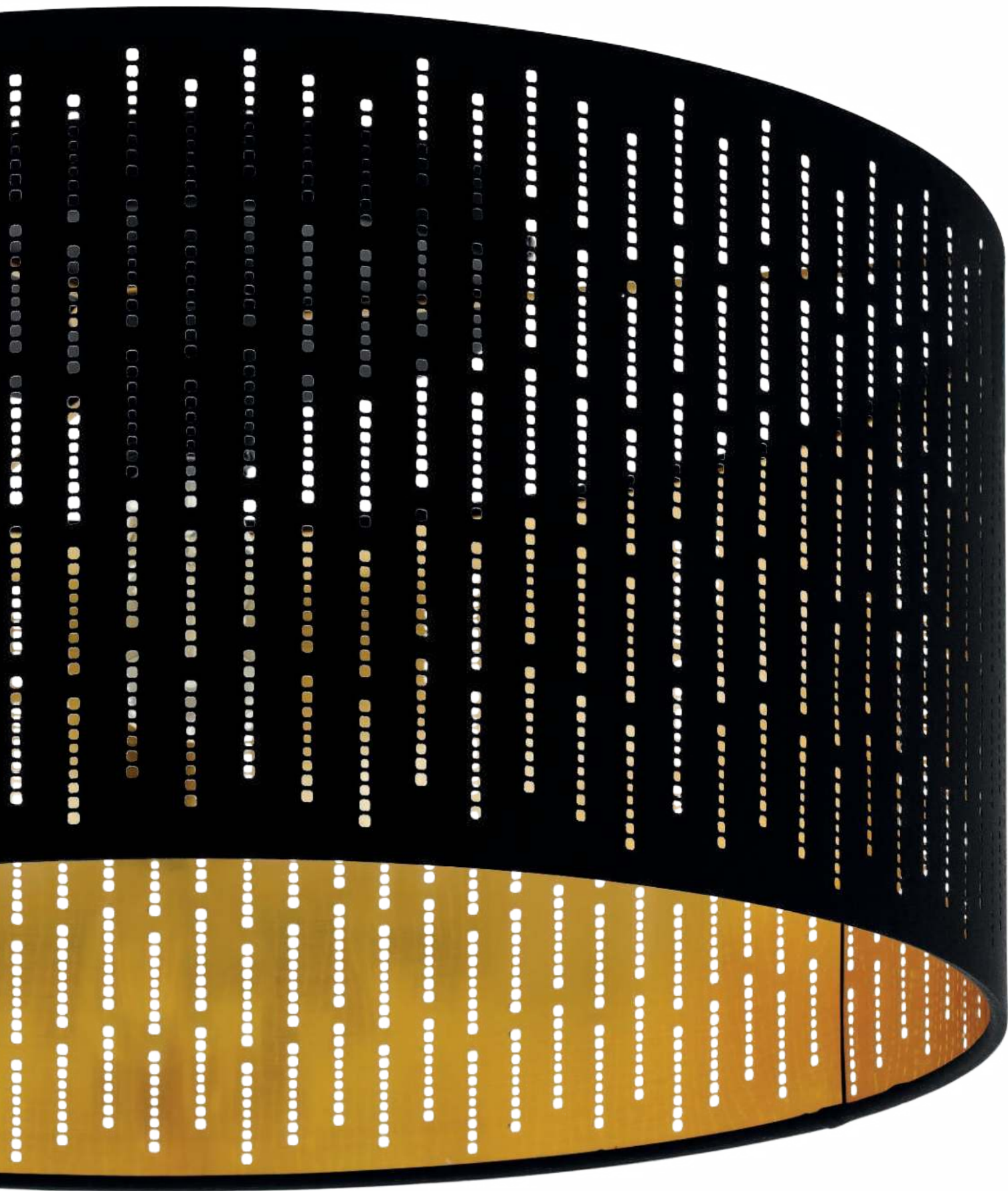

FABRIC MATERIALS

COATING



coating, silver
Beschichtung, silber
revêtement, argent

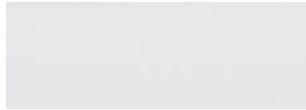

coating, white
Beschichtung, weiß
revêtement, blanc



coating, black
Beschichtung, schwarz
revêtement, noir



coating, gold
Beschichtung, gold
revêtement, or



coating, copper
Beschichtung, kupfer
revêtement, cuivre



coating, brass
Beschichtung, messing
revêtement, laiton



coating, brass & white
Beschichtung, messing & weiß
revêtement, laiton & blanc

SHADES

GLOSSY



fabric, glossy black
Textil, samtglänzend schwarz
tissu, velours noir brillant



fabric, glossy cappuccino
Textil, samtglänzend cappuccino
tissu, velours cappuccino brillant

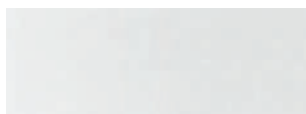

fabric, glossy white
Textil, samtglänzend weiß
tissu, velours blanc brillant

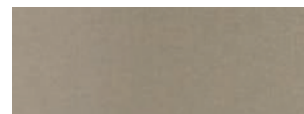

fabric, glossy taupe
Textil, samtglänzend taupe
tissu, velours taupe brillant



fabric, glossy grey
Textil, samtglänzend grau
tissu, velours gris brillant



fabric, glossy gold
Textil, samtglänzend gold
tissu, velours or brillant

MAT



fabric, mat black
Textil, matt schwarz
tissu, tapis noir



fabric, mat anthracite-brown
Textil, matt anthrazit-braun
tissu, tapis anthracite-marron



fabric, mat white
Textil, matt weiß
tissu, tapis blanc

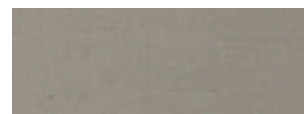

fabric, mat taupe
Textil, matt taupe
tissu, tapis taupe



fabric, mat grey
Textil, matt grau
tissu, tapis gris



fabric, mat white & gold
Textil, matt weiß & gold
tissu, tapis blanc & or

LINEN



linen, grey
Leinen, grau
lin, gris



linen, brown
Leinen, braun
lin, marron



97777

LED

incl./inkl./inclus



97782

LED

incl./inkl./inclus



97779

LED

incl./inkl./inclus

97777 ROMAO 1

ceiling light; steel, white / fabric, plastic, white
Deckenleuchte; Stahl, weiss / Textil, Kunststoff, weiss
plafonnier; acier, blanc / tissu, plastique, blanc

H 120, Ø 570

LED

36W

tunable
WHITE

4300lm



CONTROL
UNIT

Remote

97782 ROMAO 1

ceiling light; steel, white / fabric, plastic, white
Deckenleuchte; Stahl, weiss / Textil, Kunststoff, weiss
plafonnier; acier, blanc / tissu, plastique, blanc

H 120, Ø 760

LED

54W

tunable
WHITE

6500lm



CONTROL
UNIT

Remote

97779 ROMAO

ceiling light; steel, white / fabric linen, plastic, grey, white
Deckenleuchte; Stahl, weiss / Textil Leinen, Kunststoff, grau,
weiss
plafonnier; acier, blanc / tissu de lin, plastique, gris, blanc

H 120, Ø 570

LED

36W

tunable
WHITE

4300lm



CONTROL
UNIT

Remote



9 002759 977771



Ø 570



9 002759 977825



Ø 760



9 002759 977795



Ø 570



97784

LED

incl./inkl./inclus



97778

LED

incl./inkl./inclus



97783

LED

incl./inkl./inclus

TUNABLE WHITE 3000 - 5000 K	DIMMABLE 10 - 100 %	TIMER FUNCTION off after 30sec.	NIGHT LIGHT FUNCTION	97777	97782
				97778	97783
				97779	97784

see page / siehe Seite / voir la page 454

97784 ROMAO

ceiling light; steel, white / fabric linen, plastic, grey, white
Deckenleuchte; Stahl, weiss / Textil Leinen, Kunststoff, grau, weiss
plafonnier; acier, blanc / tissu de lin, plastique, gris, blanc

H 120, Ø 760



97778 ROMAO 3

ceiling light; steel, white / fabric, plastic, taupe, white
Deckenleuchte; Stahl, weiss / Textil, Kunststoff, taupe, weiss
plafonnier; acier, blanc / tissu, plastique, taupe, blanc

H 120, Ø 570



97783 ROMAO 3

ceiling light; steel, white / fabric, plastic, taupe, white
Deckenleuchte; Stahl, weiss / Textil, Kunststoff, taupe, weiss
plafonnier; acier, blanc / tissu, plastique, taupe, blanc

H 120, Ø 760



9 002759 977849



9 002759 977788



9 002759 977832





97611 PASTERI

ceiling light; steel, white / fabric, white
Deckenleuchte; Stahl, weiss / Textil, weiss
plafonnier; acier, blanc / tissu, blanc

H 150, Ø 570



97615 PASTERI

ceiling light; steel, white / fabric, white
Deckenleuchte; Stahl, weiss / Textil, weiss
plafonnier; acier, blanc / tissu, blanc

H 150, Ø 760



97619 PASTERI

ceiling light; steel, white / fabric, white
Deckenleuchte; Stahl, weiss / Textil, weiss
plafonnier; acier, blanc / tissu, blanc

H 170, Ø 980





97613 PASTERI

ceiling light; steel, white / fabric, linen, grey, white
Deckenleuchte; Stahl, weiss / Textil, Leinen, grau, weiss
plafonnier; acier, blanc / tissu, lin, gris, blanc

H 150, Ø 570



97617 PASTERI

ceiling light; steel, white / fabric, linen, grey, white
Deckenleuchte; Stahl, weiss / Textil, Leinen, grau, weiss
plafonnier; acier, blanc / tissu, lin, gris, blanc

H 150, Ø 760



97622 PASTERI

ceiling light; steel, white / fabric, linen, grey, white
Deckenleuchte; Stahl, weiss / Textil, Leinen, grau, weiss
plafonnier; acier, blanc / tissu, lin, gris, blanc

H 170, Ø 980



DESIGN
HIGHLIGHT
DETAIL



97614



97618



97614 PASTERI

ceiling light; steel, white / fabric, linen, brown, white
Deckenleuchte; Stahl, weiss / Textil, Leinen, braun, weiss
plafonnier; acier, blanc / tissu, lin, marron, blanc

H 150, Ø 570



E27 3x 25W



9 002759 976149



97618 PASTERI

ceiling light; steel, white / fabric, linen, brown, white
Deckenleuchte; Stahl, weiss / Textil, Leinen, braun, weiss
plafonnier; acier, blanc / tissu, lin, marron, blanc

H 150, Ø 760



E27 5x 25W



9 002759 976187





97612 PASTERI

ceiling light; steel, white / fabric, taupe, white
Deckenleuchte; Stahl, weiss / Textil, taupe, weiss
plafonnier; acier, blanc / tissu, taupe, blanc

H 150, Ø 570



97616 PASTERI

ceiling light; steel, white / fabric, taupe, white
Deckenleuchte; Stahl, weiss / Textil, taupe, weiss
plafonnier; acier, blanc / tissu, taupe, blanc

H 150, Ø 760



97621 PASTERI

ceiling light; steel, white / fabric, taupe, white
Deckenleuchte; Stahl, weiss / Textil, taupe, weiss
plafonnier; acier, blanc / tissu, taupe, blanc

H 170, Ø 980





PASTERI SQUARE
POSADERRA



99089



99298

99089 PASTERI SQUARE

ceiling light; steel, white / fabric, plastic, white
Deckenleuchte; Stahl, weiss / Textil, Kunststoff, weiss
plafonnier; acier, blanc / tissu, plastique, blanc

L 575, B 575, H 165



E27



5x 25W

99298 POSADERRA

ceiling light; steel, white / fabric, plastic, white
Deckenleuchte; Stahl, weiss / Textil, Kunststoff, weiss
plafonnier; acier, blanc / tissu, plastique, blanc

L 750, B 280, H 150



E27



3x 28W



9 002759 990893



9 002759 992989

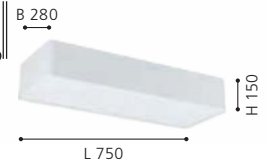



99091



99092

99091 PASTERI SQUARE

ceiling light; steel, white / fabric, plastic, taupe, white
 Deckenleuchte; Stahl, weiss / Textil, Kunststoff, taupe, weiss
 plafonnier; acier, blanc / tissu, plastique, taupe, blanc

L 575, B 575, H 165



E27



5x 25W

99092 PASTERI SQUARE

ceiling light; steel, white / fabric, plastic, grey, white
 Deckenleuchte; Stahl, weiss / Textil, Kunststoff, grau, weiss
 plafonnier; acier, blanc / tissu, plastique, gris, blanc

L 575, B 575, H 165



E27



5x 25W



9 002759 990916

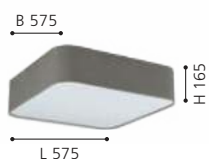

9 002759 990923





93395

LED



96538

LED



93397

LED

93395 PALOMARO

ceiling light; plastic, white / fabric, anthracite
Deckenleuchte; Kunststoff, weiss / Textil, anthrazit
plafonnier; plastique, blanc / tissu, anthracite

H 90, Ø 320

LED

warm
WHITE



3x 3,6W 1110lm

96538 PALOMARO 1

ceiling light; plastic, white / fabric, anthracite
Deckenleuchte; Kunststoff, weiss / Textil, anthrazit
plafonnier; plastique, blanc / tissu, anthracite

H 100, Ø 405

LED

warm
WHITE



18W 2000lm

93397 PALOMARO

ceiling light; plastic, white / fabric, anthracite
Deckenleuchte; Kunststoff, weiss / Textil, anthrazit
plafonnier; plastique, blanc / tissu, anthracite

H 110, Ø 500

LED

warm
WHITE



4x 5,4W 2200lm



9 002759 933951



9 002759 965389



9 002759 933975





93949



96539



93952



93949 PALOMARO

ceiling light; plastic, white / fabric, taupe
Deckenleuchte; Kunststoff, weiss / Textil, taupe
plafonnier; plastique, blanc / tissu, taupe

H 90, Ø 320



3x 3,6W 1110lm

96539 PALOMARO 1

ceiling light; plastic, white / fabric, taupe
Deckenleuchte; Kunststoff, weiss / Textil, taupe
plafonnier; plastique, blanc / tissu, taupe

H 100, Ø 405



18W 2000lm

93952 PALOMARO

ceiling light; plastic, white / fabric, taupe
Deckenleuchte; Kunststoff, weiss / Textil, taupe
plafonnier; plastique, blanc / tissu, taupe

H 110, Ø 500



4x 5,4W 2200lm



9 002759 939496



9 002759 965396



9 002759 939526





97479



97838



98409

97479 PASTORE

ceiling light; steel, white / fabric, anthracite-brown, white, grey
Deckenleuchte; Stahl, weiss / Textil, anthrazit-braun, weiss, grau
plafonnier; acier, blanc / tissu, marron anthracite, blanc, gris

L 610, B 495, H 255



E27 3x 60W

97838 PASTORE

ceiling light; steel, white / fabric, brown, grey, white, black
Deckenleuchte; Stahl, weiss / Textil, braun, grau, weiss, schwarz
plafonnier; acier, blanc / tissu, marron, gris, blanc, noir

H 285, Ø 990



E27 6x 40W

98409 PASTORE 1

ceiling light; steel, white / fabric, taupe
Deckenleuchte; Stahl, weiss / Textil, taupe
plafonnier; acier, blanc / tissu, taupe

H 250, Ø 990



E27 6x 40W



9 002759 974794

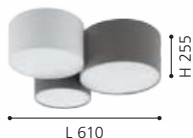

9 002759 978389



9 002759 984090





99508



99509



PASTORE | PASTORE 1
PASTORE 2

99508 PASTORE 2

ceiling light; steel, white / fabric, black, white
Deckenleuchte; Stahl, weiss / Textil, schwarz, weiss
plafonnier; acier, blanc / tissu, noir, blanc

L 610, B 495, H 255



E27 3x 60W



9 002759 995089



L 610

99509 PASTORE 2

ceiling light; steel, white / fabric, black, white
Deckenleuchte; Stahl, weiss / Textil, schwarz, weiss
plafonnier; acier, blanc / tissu, noir, blanc

H 285, Ø 990



E27 6x 40W



9 002759 995096

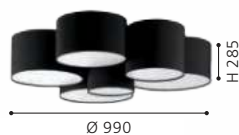

Ø 990

DESIGN
HIGHLIGHT
DETAIL



31581



31572

31581 PASTERI

pendant light; steel, satin nickel / fabric, taupe
 Hängeleuchte; Stahl, nickel-matt / Textil, taupe
 luminaire en suspension; acier, nickel mat / tissu, taupe

L 750, B 220, H 1100

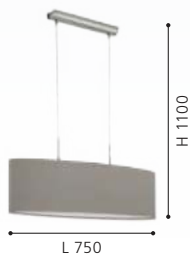

31572 PASTERI

pendant light; steel, satin nickel / fabric, taupe
 Hängeleuchte; Stahl, nickel-matt / Textil, taupe
 luminaire en suspension; acier, nickel mat / tissu, taupe

H 1100, Ø 380



31589 PASTERI

ceiling light; plastic, steel, white / fabric, taupe
 Deckenleuchte; Kunststoff, Stahl, weiss / Textil, taupe
 plafonnier; plastique, acier, blanc / tissu, taupe

H 90, Ø 320





31589

LED



31576

31576 PASTERI

pendant light; steel, satin nickel / fabric, taupe
Hängeleuchte; Stahl, nickel-matt / Textil, taupe
luminaire en suspension; acier, nickel mat / tissu, taupe

H 1100, Ø 530



E27



1x 60W



9 002759 315764





94919



94919



94925



96478



94919 PASTERI

ceiling light; steel, satin nickel / fabric, glass, taupe
Deckenleuchte; Stahl, nickel-matt / Textil, Glas, taupe
plafonnier; acier, nickel mat / tissu, verre, taupe

H 195, Ø 475



E27 3x 25W



9 002759 949198



94925 PASTERI

wall light; steel, satin nickel / fabric, taupe
Wandleuchte; Stahl, nickel-matt / Textil, taupe
applique; acier, nickel mat / tissu, taupe

L 145, H 305, A 195

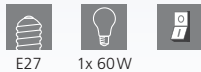

E27 1x 60W



9 002759 949259



96478 PASTERI

wall light; steel, satin nickel / fabric, taupe
Wandleuchte; Stahl, nickel-matt / Textil, taupe
applique; acier, nickel mat / tissu, taupe

L 150, H 380, A 195



E27 1x 40W 1x 3,8W 320lm



9 002759 964788

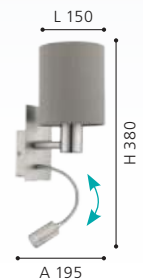



95122



95122

These luminaires can be switched on and off by touching the specially designed "Touch Me" part of the fixture.

Diese Leuchten können ein- und ausgeschaltet werden, indem man sie an den dafür vorgesehenen "Touch Me" Bereichen berührt.

Ces luminaires peuvent être éteints et allumés simplement en touchant la partie spécialement conçue pour "Touch Me" du luminaire.



31595



95167

95122 PASTERI

table light; steel, satin nickel / fabric, taupe
Tischleuchte; Stahl, nickel-matt / Textil, taupe
luminaire de table; acier, nickel mat / tissu, taupe

H 255, Ø 120

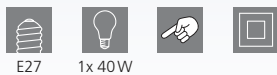

E27 1x 40W



9 002759 951221



31595 PASTERI

table light; steel, satin nickel / fabric, taupe
Tischleuchte; Stahl, nickel-matt / Textil, taupe
luminaire de table; acier, nickel mat / tissu, taupe

H 400, Ø 180

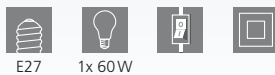

E27 1x 60W



9 002759 315955



95167 PASTERI

floor light; steel, satin nickel / fabric, taupe
Stehleuchte; Stahl, nickel-matt / Textil, taupe
lampadaire; acier, nickel mat / tissu, taupe

H 1575, Ø 280, Base: Ø 230



E27 1x 60W



9 002759 951672

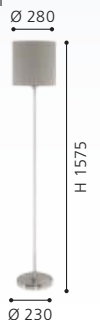



31582



31592

LED



31586

31582 PASTERI

pendant light; steel, satin nickel / fabric, grey
 Hängeleuchte; Stahl, nickel-matt / Textil, grau
 luminaire en suspension; acier, nickel mat / tissu, gris

L 750, B 220, H 1100



9 002759 315825

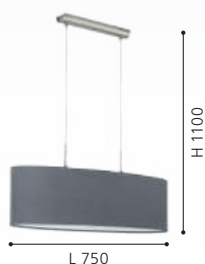

31586 PASTERI

pendant light; steel, satin nickel / fabric, grey
 Hängeleuchte; Stahl, nickel-matt / Textil, grau
 luminaire en suspension; acier, nickel mat / tissu, gris

L 1000, B 280, H 1100



9 002759 315863



31592 PASTERI

ceiling light; plastic, steel, white / fabric, grey
 Deckenleuchte; Kunststoff, Stahl, weiss / Textil, grau
 plafonnier; plastique, acier, blanc / tissu, gris

H 90, Ø 320



9 002759 315924





94921



31573



31577

94921 PASTERI

ceiling light; steel, satin nickel / fabric, glass, grey
Deckenleuchte; Stahl, nickel-matt / Textil, Glas, grau
plafonnier; acier, nickel mat / tissu, verre, gris

H 195, Ø 475



E27 3x 25W



9 002759 949211

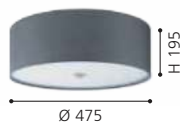

31577 PASTERI

pendant light; steel, satin nickel / fabric, grey
Hängeleuchte; Stahl, nickel-matt / Textil, grau
luminaire en suspension; acier, nickel mat / tissu, gris

H 1100, Ø 530



E27 1x 60W



9 002759 315771



31573 PASTERI

pendant light; steel, satin nickel / fabric, grey
Hängeleuchte; Stahl, nickel-matt / Textil, grau
luminaire en suspension; acier, nickel mat / tissu, gris

H 1100, Ø 380



E27 1x 60W



9 002759 315733

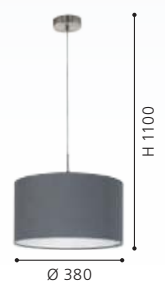



94926



96479

LED

94926 PASTERI

wall light; steel, satin nickel / fabric, grey
Wandleuchte; Stahl, nickel-matt / Textil, grau
applique; acier, nickel mat / tissu, gris

L 145, H 305, A 195



96479 PASTERI

wall light; steel, satin nickel / fabric, grey
Wandleuchte; Stahl, nickel-matt / Textil, grau
applique; acier, nickel mat / tissu, gris

L 150, H 380, A 195





95119



95119

These luminaires can be switched on and off by touching the specially designed "Touch Me" part of the fixture.

Diese Leuchten können ein- und ausgeschaltet werden, indem man sie an den dafür vorgesehenen "Touch Me" Bereichen berührt.

Ces luminaires peuvent être éteints et allumés simplement en touchant la partie spécialement conçue pour "Touch Me" du luminaire.



31596



95166

95119 PASTERI

table light; steel, satin nickel / fabric, grey
Tischleuchte; Stahl, nickel-matt / Textil, grau
luminaire de table; acier, nickel mat / tissu, gris

H 255, Ø 120



E27 1x 40W



9 002759 951191



31596 PASTERI

table light; steel, satin nickel / fabric, grey
Tischleuchte; Stahl, nickel-matt / Textil, grau
luminaire de table; acier, nickel mat / tissu, gris

H 400, Ø 180



E27 1x 60W



9 002759 315962



95166 PASTERI

floor light; steel, satin nickel / fabric, grey
Stehleuchte; Stahl, nickel-matt / Textil, grau
lampadaire; acier, nickel mat / tissu, gris

H 1575, Ø 280, Base: Ø 230



E27 1x 60W



9 002759 951665





31578



31574



96481

The main and reading lights can be switched on separately.

Das Haupt- und das Leselicht können getrennt voneinander geschaltet werden.

Les luminaires principales et de lecture peuvent être allumées séparément.



96481

LED

31578 PASTERI

pendant light; steel, satin nickel / fabric, anthracite-brown
Hängeleuchte; Stahl, nickel-matt / Textil, anthrazit-braun
luminaire en suspension; acier, nickel mat / tissu, marron anthracite

H 1100, Ø 530



31574 PASTERI

pendant light; steel, satin nickel / fabric, anthracite-brown
Hängeleuchte; Stahl, nickel-matt / Textil, anthrazit-braun
luminaire en suspension; acier, nickel mat / tissu, marron anthracite

H 1100, Ø 380



96481 PASTERI

wall light; steel, satin nickel / fabric, anthracite-brown
Wandleuchte; Stahl, nickel-matt / Textil, anthrazit-braun
applique; acier, nickel mat / tissu, marron anthracite

L 150, H 380, A 195





31579



31575



31579 PASTERI

pendant light; steel, satin nickel / fabric, white
 Hängeleuchte; Stahl, nickel-matt / Textil, weiss
 luminaire en suspension; acier, nickel mat / tissu, blanc

L 750, B 220, H 1100

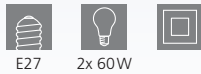

31575 PASTERI

pendant light; steel, satin nickel / fabric, white
 Hängeleuchte; Stahl, nickel-matt / Textil, weiss
 luminaire en suspension; acier, nickel mat / tissu, blanc

H 1100, Ø 530





31571



94918



31588

LED



EGLO
RECOMMENDS
110033

94918

31571 PASTERI

pendant light; steel, satin nickel / fabric, white
Hängeleuchte; Stahl, nickel-matt / Textil, weiss
luminaire en suspension; acier, nickel mat / tissu, blanc

H 1100, Ø 380



9 002759 315719



31588 PASTERI

ceiling light; plastic, steel, white / fabric, white
Deckenleuchte; Kunststoff, Stahl, weiss / Textil, weiss
plafonnier; plastique, acier, blanc / tissu, blanc

H 90, Ø 320



9 002759 315887



94918 PASTERI

ceiling light; steel, satin nickel / fabric, glass, white
Deckenleuchte; Stahl, nickel-matt / Textil, Glas, weiss
plafonnier; acier, nickel mat / tissu, verre, blanc

H 195, Ø 475



9 002759 949181





94924



95118



96477

LED

95118

These luminaires can be switched on and off by touching the specially designed "Touch Me" part of the fixture.

Diese Leuchten können ein- und ausgeschaltet werden, indem man sie an den dafür vorgesehenen "Touch Me" Bereichen berührt.

Ces luminaires peuvent être éteints et allumés simplement en touchant la partie spécialement conçue pour "Touch Me" du luminaire.



96477 PASTERI

wall light; steel, satin nickel / fabric, white
Wandleuchte; Stahl, nickel-matt / Textil, weiss
applique; acier, nickel mat / tissu, blanc

L 150, H 380, A 195



9 002759 964771

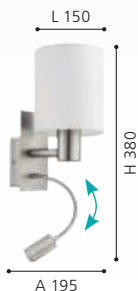

94924 PASTERI

wall light; steel, satin nickel / fabric, white
Wandleuchte; Stahl, nickel-matt / Textil, weiss
applique; acier, nickel mat / tissu, blanc

L 145, H 305, A 195



9 002759 949242



95118 PASTERI

table light; steel, satin nickel / fabric, white
Tischleuchte; Stahl, nickel-matt / Textil, weiss
luminaire de table; acier, nickel mat / tissu, blanc

H 255, Ø 120



9 002759 951184





31594



95164

31594 PASTERI

table light; steel, satin nickel / fabric, white
Tischleuchte; Stahl, nickel-matt / Textil, weiss
luminaire de table; acier, nickel mat / tissu, blanc

H 400, Ø 180

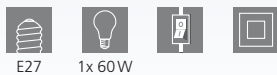

E27 1x 60W



95164 PASTERI

floor light; steel, satin nickel / fabric, white
Stehleuchte; Stahl, nickel-matt / Textil, weiss
lampadaire; acier, nickel mat / tissu, blanc

H 1575, Ø 280, Base: Ø 230



E27 1x 60W





95044



95045

95044 PASTERI

pendant light; steel, satin nickel / fabric, white, copper
Hängeleuchte; Stahl, nickel-matt / Textil, weiss, kupfer
luminaire en suspension; acier, nickel mat / tissu, blanc, cuivre

H 1100, Ø 380



E27



1x 60W



9 002759 950446



95045 PASTERI

pendant light; steel, satin nickel / fabric, white, copper
Hängeleuchte; Stahl, nickel-matt / Textil, weiss, kupfer
luminaire en suspension; acier, nickel mat / tissu, blanc, cuivre

H 1100, Ø 530



E27



1x 60W



9 002759 950453





96483

LED



96484

LED

96483 PASTERI

wall light; steel, satin nickel / fabric, black, copper
Wandleuchte; Stahl, nickel-matt / Textil, schwarz, kupfer
applique; acier, nickel mat / tissu, noir, cuivre

L 150, H 380, A 195



E27



1x 40W



1x 3,8W



320lm



9 002759 964832

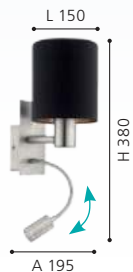

96484 PASTERI

wall light; steel, satin nickel / fabric, white, copper
Wandleuchte; Stahl, nickel-matt / Textil, weiss, kupfer
applique; acier, nickel mat / tissu, blanc, cuivre

L 150, H 380, A 195



E27



1x 40W



1x 3,8W



320lm



9 002759 964849



96483, 96484

The main and reading lights can be switched on separately.

Das Haupt- und das Leselicht können getrennt voneinander geschaltet werden.

Les luminaires principales et de lecture peuvent être allumées séparément.



97643



97644

97643 VISERBELLA

pendant light; steel, champagne / fabric, gold
 Hängeleuchte; Stahl, champagner / Textil, gold
 luminaire en suspension; acier, champagne / tissu, doré

H 1100, Ø 380



97644 VISERBELLA

pendant light; steel, champagne / fabric, gold
 Hängeleuchte; Stahl, champagner / Textil, gold
 luminaire en suspension; acier, champagne / tissu, doré

H 1100, Ø 530



97641 VISERBELLA

ceiling light; steel, champagne / fabric, gold
 Deckenleuchte; Stahl, champagner / Textil, gold
 plafonnier; acier, champagne / tissu, doré

H 110, Ø 380





97641



97642



97641 | 97642



97642 VISERBELLA

ceiling light; steel, champagne / fabric, gold
Deckenleuchte; Stahl, champagner / Textil, gold
plafonnier; acier, champagne / tissu, doré

H 195, Ø 470

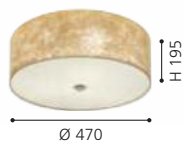



DESIGN
HIGHLIGHT
DETAIL



97645



97647

97645 VISERBELLA

wall light; steel, champagne / fabric, gold
Wandleuchte; Stahl, champagner / Textil, gold
applique; acier, champagne / tissu, doré

L 145, H 305, A 195



E27 1x 60W



9 002759 976453



97647 VISERBELLA

floor light; steel, champagne / fabric, gold
Stehleuchte; Stahl, champagner / Textil, gold
lampadaire; acier, champagne / tissu, doré

H 1585, Ø 280, Base: Ø 230

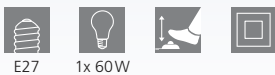

E27 1x 60W



9 002759 976477



97646 VISERBELLA

table light; steel, champagne / fabric, gold
Tischleuchte; Stahl, champagner / Textil, gold
luminaire de table; acier, champagne / tissu, doré

H 400, Ø 180, Base: Ø 150

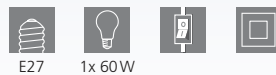

E27 1x 60W



9 002759 976460





97646



DESIGN
HIGHLIGHT
DETAIL



99272

99273

99273 ESTEPERRA

pendant light; steel, black / fabric, black, gold
Hängeleuchte; Stahl, schwarz / Textil, schwarz, gold
luminaire en suspension; acier, noir / tissu, noir, or

H 1100, Ø 380



E27

1x 40W



9 002759 992736



99272 ESTEPERRA

ceiling light; steel, black / fabric, black, gold
Deckenleuchte; Stahl, schwarz / Textil, schwarz, gold
plafonnier; acier, noir / tissu, noir, or

H 240, Ø 475



E27

1x 40W



9 002759 992729



99274 ESTEPERRA

pendant light; steel, black / fabric, black, gold
Hängeleuchte; Stahl, schwarz / Textil, schwarz, gold
luminaire en suspension; acier, noir / tissu, noir, or

H 1100, Ø 530



E27

3x 40W



9 002759 992743





99274



99279

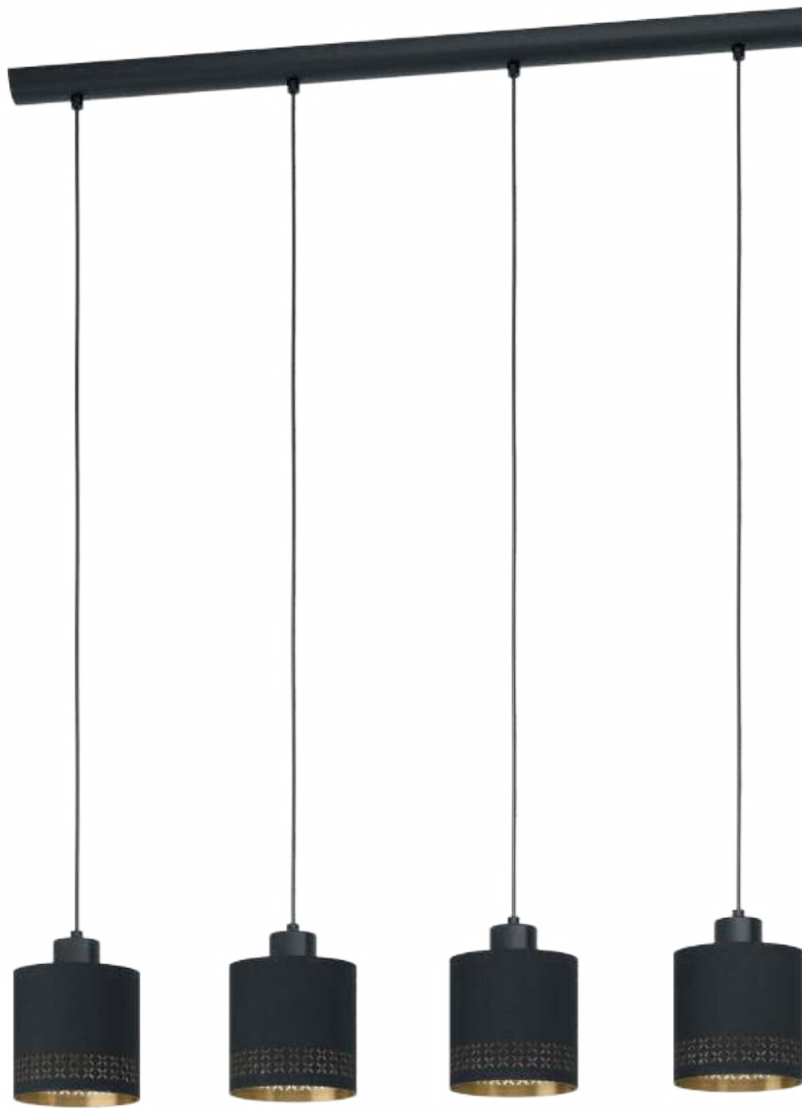

DESIGN
HIGHLIGHT
DETAIL



99279 ESTEPERRA

floor light; steel, black / fabric, black, gold
Stehleuchte; Stahl, schwarz / Textil, schwarz, gold
lampadaire; acier, noir / tissu, noir, or

H 1405, Ø 380, Base: Ø 645



E27 1x 40W



9 002759 992798



99275 ESTEPERRA

pendant light; steel, black / fabric, black, gold
Hängeleuchte; Stahl, schwarz / Textil, schwarz, gold
luminaire en suspension; acier, noir / tissu, noir, or

L 940, B 160, H 1100



E27 4x 28W



9 002759 992750





98313

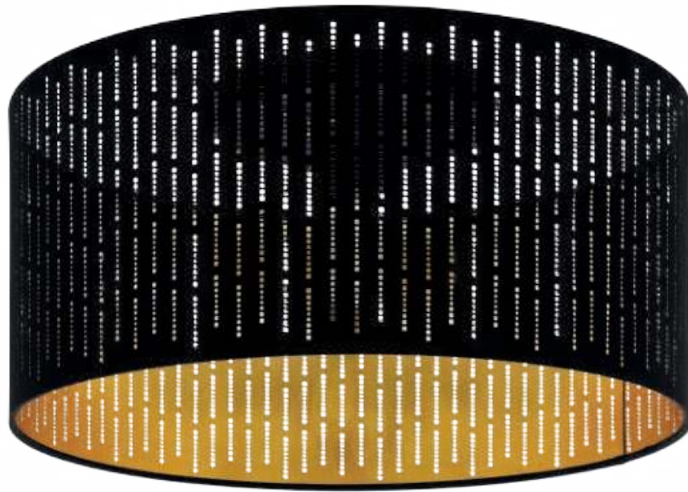

98311



98314



98313 VARILLAS

pendant light; steel, black / fabric with cut-outs, black, gold
 Hängeleuchte; Stahl, schwarz / Textil mit Ausstanzungen, schwarz, gold
 luminaire en suspension; acier, noir / tissu avec découpes, noir, or

H 1100, Ø 530



98311 VARILLAS

ceiling light; steel, black / fabric with cut-outs, black, gold
 Deckenleuchte; Stahl, schwarz / Textil mit Ausstanzungen, schwarz, gold
 plafonnier; acier, noir / tissu avec découpes, noir, or

H 240, Ø 475

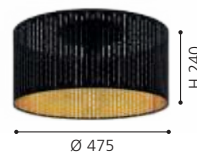

98314 VARILLAS

table light; steel, black / fabric with cut-outs, black, gold
 Tischleuchte; Stahl, schwarz / Textil mit Ausstanzungen, schwarz, gold
 luminaire de table; acier, noir / tissu avec découpes, noir, or

H 255, Ø 120

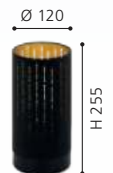
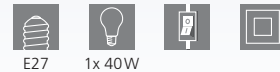



99613

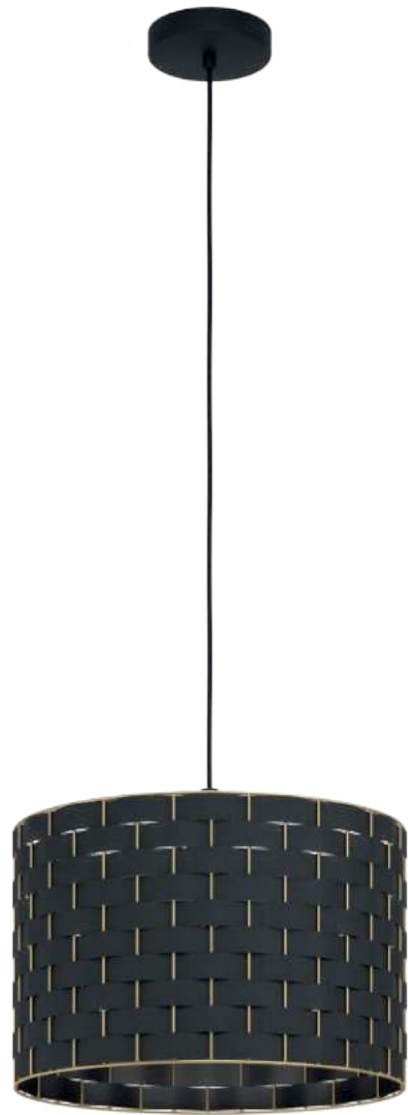

99524

99613 MARASALES

pendant light; steel, black / fabric, black, brass
 Hängeleuchte; Stahl, schwarz / Textil, schwarz, messing
 luminaire en suspension; acier, noir / tissu, noir, laiton

L 780, B 220, H 1100

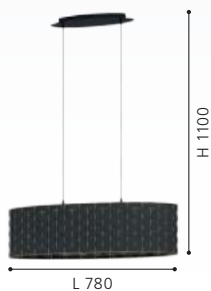

99524 MARASALES

pendant light; steel, black / fabric, black, brass
 Hängeleuchte; Stahl, schwarz / Textil, schwarz, messing
 luminaire en suspension; acier, noir / tissu, noir, laiton

H 1100, Ø 380



99525 MARASALES

pendant light; steel, black / fabric, black, brass
 Hängeleuchte; Stahl, schwarz / Textil, schwarz, messing
 luminaire en suspension; acier, noir / tissu, noir, laiton

H 1100, Ø 550

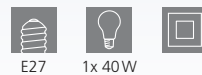

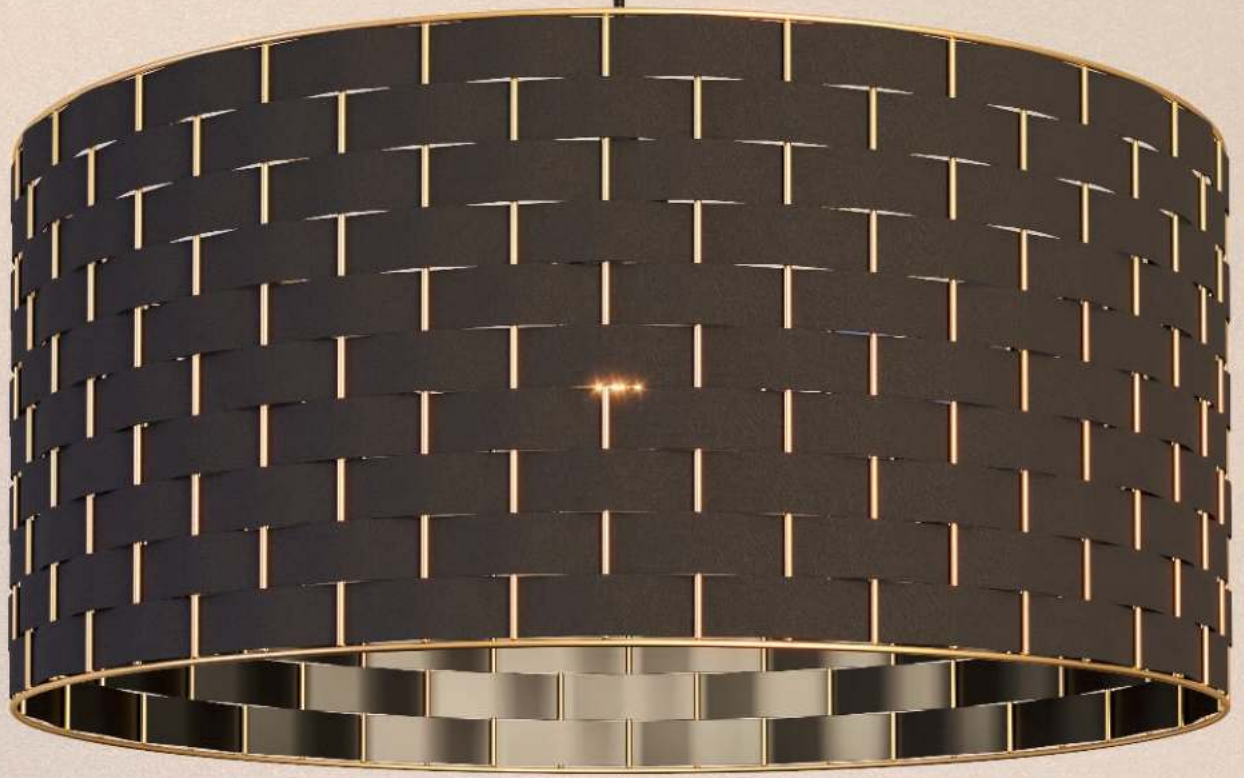

99525





99523



99526

99523 MARASALES

ceiling light; steel, black / fabric, black, brass
Deckenleuchte; Stahl, schwarz / Textil, schwarz, messing
plafonnier; acier, noir / tissu, noir, laiton

H 250, Ø 480

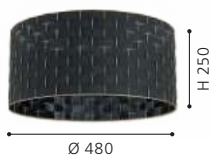

99526 MARASALES

table light; steel, black / fabric, black, brass
Tischleuchte; Stahl, schwarz / Textil, schwarz, messing
luminaire de table; acier, noir / tissu, noir, laiton

H 570, Ø 280

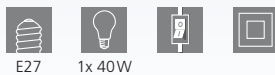

99527 MARASALES

floor light; steel, black / fabric, black, brass
Stehleuchte; Stahl, schwarz / Textil, schwarz, messing
lampadaire; acier, noir / tissu, noir, laiton

H 1490, Ø 450, Base: Ø 745

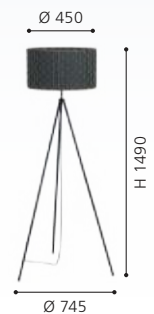
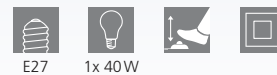



99527



900145



900144

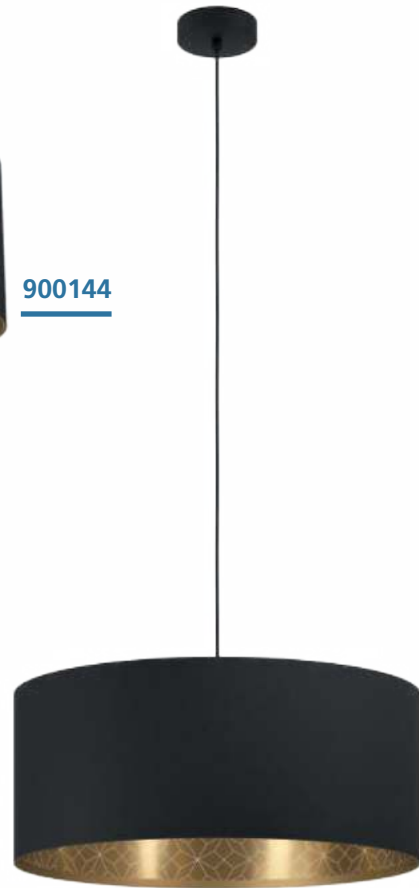

900146

900145 ZARAGOZA

pendant light; steel, black / fabric with decor, black, gold
Hängeleuchte; Stahl, schwarz / Textil mit Dekor, schwarz, gold
luminaire en suspension; acier, noir / tissu avec décor, noir, or

H 1100, Ø 380



900144 ZARAGOZA

ceiling light; steel, black / fabric with decor, black, gold
Deckenleuchte; Stahl, schwarz / Textil mit Dekor, schwarz, gold
plafonnier; acier, noir / tissu avec décor, noir, or

H 240, Ø 475



900146 ZARAGOZA

pendant light; steel, black / fabric with decor, black, gold
Hängeleuchte; Stahl, schwarz / Textil mit Dekor, schwarz, gold
luminaire en suspension; acier, noir / tissu avec décor, noir, or

H 1100, Ø 530

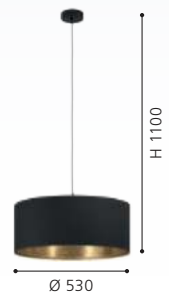



900147

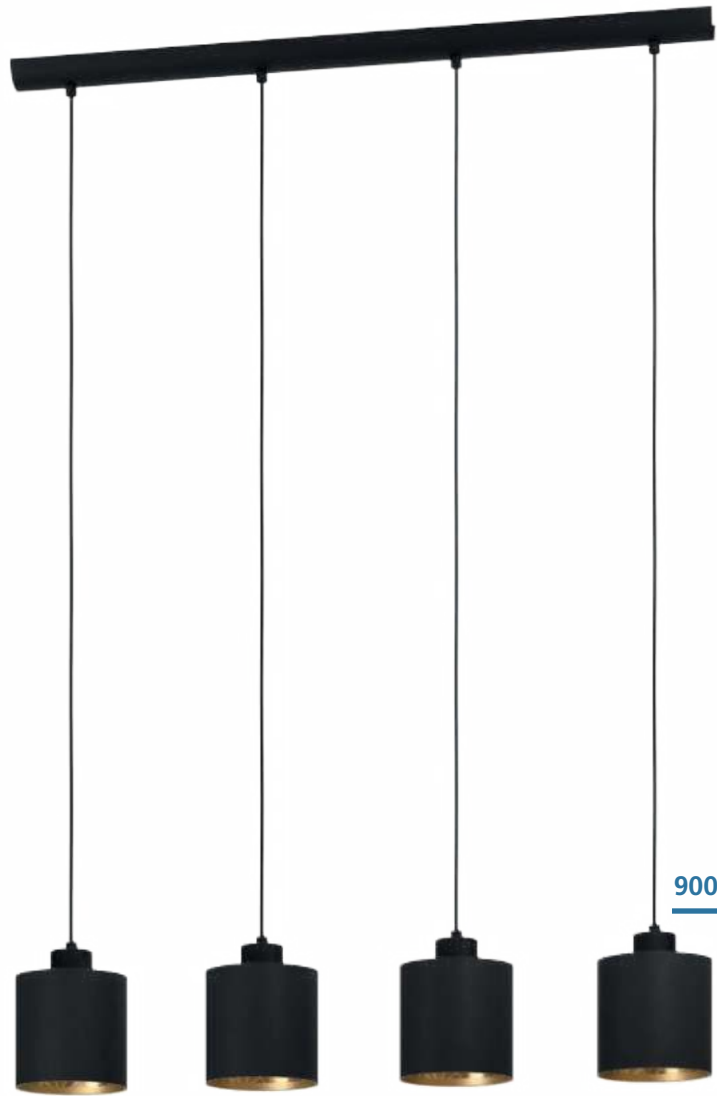

900148

900147 ZARAGOZA

pendant light; steel, black / fabric with decor, black, gold
 Hängeleuchte; Stahl, schwarz / Textil mit Dekor, schwarz, gold
 luminaire en suspension; acier, noir / tissu avec décor, noir, or

L 780, B 220, H 1100

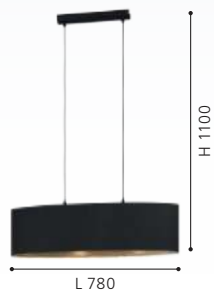

900148 ZARAGOZA

pendant light; steel, black / fabric with decor, black, gold
 Hängeleuchte; Stahl, schwarz / Textil mit Dekor, schwarz, gold
 luminaire en suspension; acier, noir / tissu avec décor, noir, or

L 925, B 160, H 1100

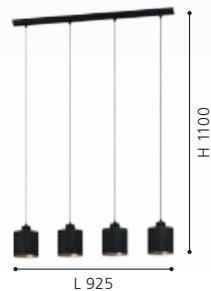



900634

900634 BUCAMARANGA

ceiling light; steel, white / fabric with decor, white, gold
Deckenleuchte; Stahl, weiss / Textil mit Dekor, weiss, gold
plafonnier; acier, blanc / tissu avec décor, blanc, or

H 240, Ø 475



900635 BUCAMARANGA

pendant light; steel, white / fabric with decor, white, gold
Hängeleuchte; Stahl, weiss / Textil mit Dekor, weiss, gold
luminaire en suspension; acier, blanc / tissu avec décor, blanc, or

H 1100, Ø 530





900635





31601



99543

LED



31606

31601 MASERLO

pendant light; steel, satin nickel / fabric, grey, silver
 Hängeleuchte; Stahl, nickel-matt / Textil, grau, silber
 luminaire en suspension; acier, nickel mat / tissu, gris, argent

H 1100, Ø 380



9 002759 316013



31606 MASERLO

pendant light; steel, satin nickel / fabric, grey, silver
 Hängeleuchte; Stahl, nickel-matt / Textil, grau, silber
 luminaire en suspension; acier, nickel mat / tissu, gris, argent

H 1100, Ø 530



9 002759 316068



99543 MASERLO 2

ceiling light; plastic, steel, white / fabric, grey, silver
 Deckenleuchte; Kunststoff, Stahl, weiss / Textil, grau, silber
 plafonnier; plastique, acier, blanc / tissu, gris, argent

H 90, Ø 380



9 002759 995430





31628



95173



31628 MASERLO

table light; steel, satin nickel / fabric, grey, silver
Tischleuchte; Stahl, nickel-matt / Textil, grau, silber
luminaire de table; acier, nickel mat / tissu, gris, argent

H 420, Ø 230

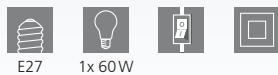

E27 1x 60W



9 002759 316280



95173 MASERLO

floor light; steel, satin nickel / fabric, grey, silver
Stehleuchte; Stahl, nickel-matt / Textil, grau, silber
lampadaire; acier, nickel mat / tissu, gris, argent

H 1510, Ø 380, Base: Ø 250



E27 1x 60W



9 002759 951733

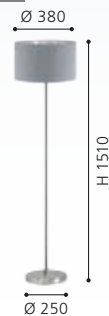



99044



99042



99043



MASERLO 1

99044 MASERLO 1

pendant light; steel, black / fabric, black
 Hängeleuchte; Stahl, schwarz / Textil, schwarz
 luminaire en suspension; acier, noir / tissu, noir

L 780, B 220, H 1100

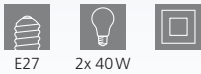

99042 MASERLO 1

pendant light; steel, black / fabric, black
 Hängeleuchte; Stahl, schwarz / Textil, schwarz
 luminaire en suspension; acier, noir / tissu, noir

H 1100, Ø 380

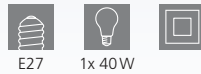

99043 MASERLO 1

pendant light; steel, black / fabric, black
 Hängeleuchte; Stahl, schwarz / Textil, schwarz
 luminaire en suspension; acier, noir / tissu, noir

H 1100, Ø 530

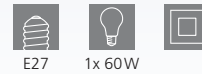



DESIGN
HIGHLIGHT
DETAIL



99041



MASERLO 1



99045

99041 MASERLO 1

ceiling light; steel, black / fabric, black
Deckenleuchte; Stahl, schwarz / Textil, schwarz
plafonnier; acier, noir / tissu, noir

H 240, Ø 400



E27 1x 40W



9 002759 990411

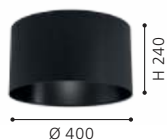

99045 MASERLO 1

table light; steel, black / fabric, black
Tischleuchte; Stahl, schwarz / Textil, schwarz
luminaire de table; acier, noir / tissu, noir

H 415, Ø 230, Base: Ø 145



E27 1x 40W



9 002759 990459



99046 MASERLO 1

floor light; steel, black / fabric, black
Stehleuchte; Stahl, schwarz / Textil, schwarz
lampadaire; acier, noir / tissu, noir

H 1515, Ø 380, Base: Ø 250



E27 1x 40W



9 002759 990466

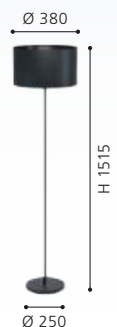



99046



31611



31616



31611 MASERLO

pendant light; steel, satin nickel / fabric, black, gold
 Hängeleuchte; Stahl, nickel-matt / Textil, schwarz, gold
 luminaire en suspension; acier, nickel mat / tissu, noir, or

L 780, B 220, H 1100

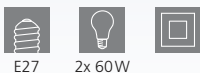

E27 2x 60W

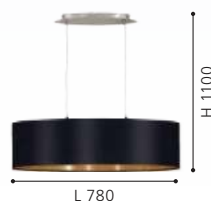

31616 MASERLO

pendant light; steel, satin nickel / fabric, black, gold
 Hängeleuchte; Stahl, nickel-matt / Textil, schwarz, gold
 luminaire en suspension; acier, nickel mat / tissu, noir, or

L 1000, B 250, H 1100



E27 2x 60W

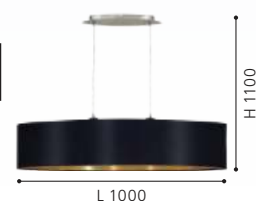



31599



31605

31599 MASERLO

pendant light; steel, satin nickel / fabric, black, gold
 Hängeleuchte; Stahl, nickel-matt / Textil, schwarz, gold
 luminaire en suspension; acier, nickel mat / tissu, noir, or

H 1100, Ø 380

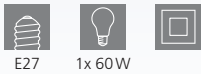

E27 1x 60W



9 002759 315993

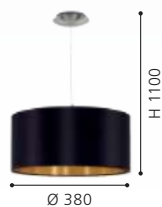

31605 MASERLO

pendant light; steel, satin nickel / fabric, black, gold
 Hängeleuchte; Stahl, nickel-matt / Textil, schwarz, gold
 luminaire en suspension; acier, nickel mat / tissu, noir, or

H 1100, Ø 530



E27 3x 60W



9 002759 316051

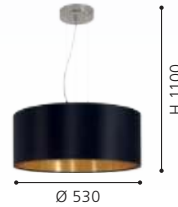



99539

LED



DESIGN
HIGHLIGHT
DETAIL



31627

99539 MASERLO 2

ceiling light; plastic, steel, white / fabric, black, gold
Deckenleuchte; Kunststoff, Stahl, weiss / Textil, schwarz, gold
plafonnier; plastique, acier, blanc / tissu, noir, or

H 90, Ø 380



21,6W 2500lm



9 002759 995393

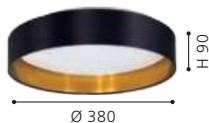

31627 MASERLO

table light; steel, satin nickel / fabric, black, gold
Tischleuchte; Stahl, nickel-matt / Textil, schwarz, gold
luminaire de table; acier, nickel mat / tissu, noir, or

H 420, Ø 230



E27 1x 60W



9 002759 316273



95169 MASERLO

floor light; steel, satin nickel / fabric, black, gold
Stehleuchte; Stahl, nickel-matt / Textil, schwarz, gold
lampadaire; acier, nickel mat / tissu, noir, or

H 1510, Ø 380, Base: Ø 250



E27 1x 60W



9 002759 951696

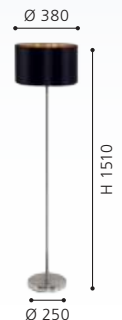



95169



31618

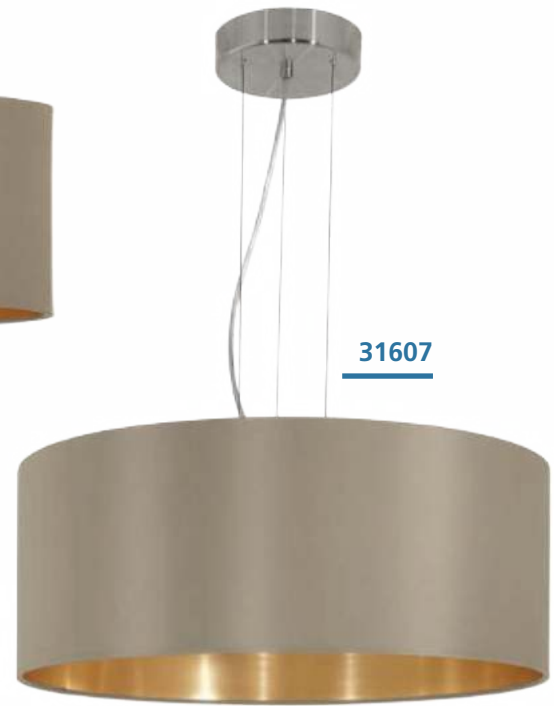

31607



31618 MASERLO

pendant light; steel, satin nickel / fabric, taupe, gold
 Hängeleuchte; Stahl, nickel-matt / Textil, taupe, gold
 luminaire en suspension; acier, nickel mat / tissu, taupe, or

L 1000, B 250, H 1100

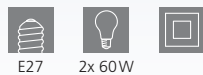

E27 2x 60W

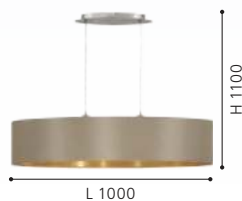

31607 MASERLO

pendant light; steel, satin nickel / fabric, taupe, gold
 Hängeleuchte; Stahl, nickel-matt / Textil, taupe, gold
 luminaire en suspension; acier, nickel mat / tissu, taupe, or

H 1100, Ø 530



E27 3x 60W

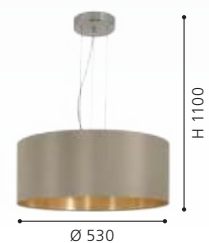



99541



31602



31613

31602 MASERLO

pendant light; steel, satin nickel / fabric, taupe, gold
Hängeleuchte; Stahl, nickel-matt / Textil, taupe, gold
luminaire en suspension; acier, nickel mat / tissu, taupe, or

H 1100, Ø 380



E27 1x 60W



9 002759 316020



99541 MASERLO 2

ceiling light; plastic, steel, white / fabric, taupe, gold
Deckenleuchte; Kunststoff, Stahl, weiss / Textil, taupe, gold
plafonnier; plastique, acier, blanc / tissu, taupe, or

H 90, Ø 380



LED 21,6W 2500lm



9 002759 995416

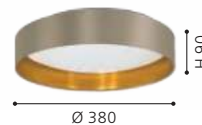

31613 MASERLO

pendant light; steel, satin nickel / fabric, taupe, gold
Hängeleuchte; Stahl, nickel-matt / Textil, taupe, gold
luminaire en suspension; acier, nickel mat / tissu, taupe, or

L 780, B 220, H 1100



E27 2x 60W



9 002759 316136

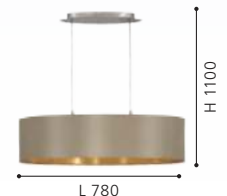



95055



31629



95171

95055 MASERLO

wall light; steel, satin nickel / fabric, taupe, gold
Wandleuchte; Stahl, nickel-matt / Textil, taupe, gold
applique; acier, nickel mat / tissu, taupe, or

H 260, Ø 230, A 595

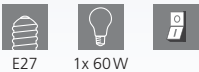

E27 1x 60W



9 002759 950552



31629 MASERLO

table light; steel, satin nickel / fabric, taupe, gold
Tischleuchte; Stahl, nickel-matt / Textil, taupe, gold
luminaire de table; acier, nickel mat / tissu, taupe, or

H 420, Ø 230

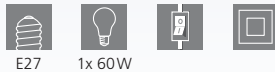

E27 1x 60W



9 002759 316297



95171 MASERLO

floor light; steel, satin nickel / fabric, taupe, gold
Stehleuchte; Stahl, nickel-matt / Textil, taupe, gold
lampadaire; acier, nickel mat / tissu, taupe, or

H 1510, Ø 380, Base: Ø 250



E27 1x 60W



9 002759 951719





31614

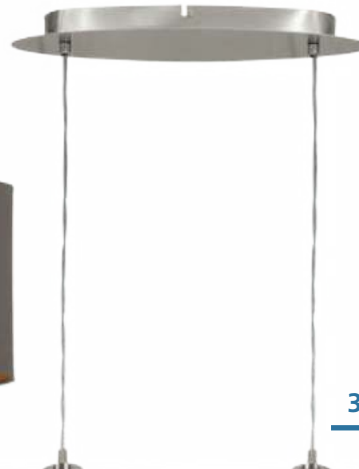

31619



31603

31614 MASERLO

pendant light; steel, satin nickel / fabric, cappuccino, gold
 Hängeleuchte; Stahl, nickel-matt / Textil, cappuccino, gold
 luminaire en suspension; acier, nickel mat / tissu, cappuccino, or

L 780, B 220, H 1100



E27 2x 60W



9 002759 316143

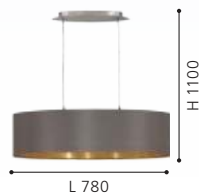

31619 MASERLO

pendant light; steel, satin nickel / fabric, cappuccino, gold
 Hängeleuchte; Stahl, nickel-matt / Textil, cappuccino, gold
 luminaire en suspension; acier, nickel mat / tissu, cappuccino, or

L 1000, B 250, H 1100



E27 2x 60W



9 002759 316198



31603 MASERLO

pendant light; steel, satin nickel / fabric, cappuccino, gold
 Hängeleuchte; Stahl, nickel-matt / Textil, cappuccino, gold
 luminaire en suspension; acier, nickel mat / tissu, cappuccino, or

H 1100, Ø 380



E27 1x 60W



9 002759 316037





99542

LED

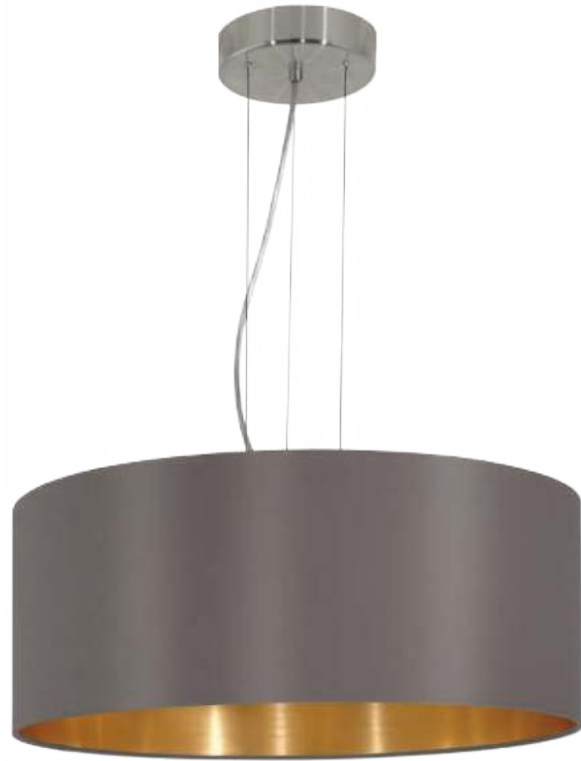

31608

99542 MASERLO 2

ceiling light; plastic, steel, white / fabric, cappuccino, gold
Deckenleuchte; Kunststoff, Stahl, weiss / Textil, cappuccino, gold
plafonnier; plastique, acier, blanc / tissu, cappuccino, or

H 90, Ø 380

LED

warm
WHITE



21,6W 2500lm



9 002759 995423

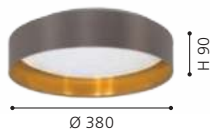

31608 MASERLO

pendant light; steel, satin nickel / fabric, cappuccino, gold
Hängeleuchte; Stahl, nickel-matt / Textil, cappuccino, gold
luminaire en suspension; acier, nickel mat / tissu, cappuccino, or

H 1100, Ø 530



E27



3x 60W



9 002759 316082



31631 MASERLO

table light; steel, satin nickel / fabric, cappuccino, gold
Tischleuchte; Stahl, nickel-matt / Textil, cappuccino, gold
luminaire de table; acier, nickel mat / tissu, cappuccino, or

H 420, Ø 230



E27



1x 60W



9 002759 316310





31631

95172 MASERLO

floor light; steel, satin nickel / fabric, cappuccino, gold
 Stehleuchte; Stahl, nickel-matt / Textil, cappuccino, gold
 lampadaire; acier, nickel mat / tissu, cappucino, or

H 1510, Ø 380, Base: Ø 250



E27



1x 60W



9 002759 951726

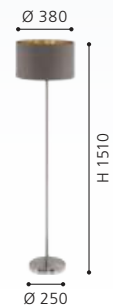

95172



97684

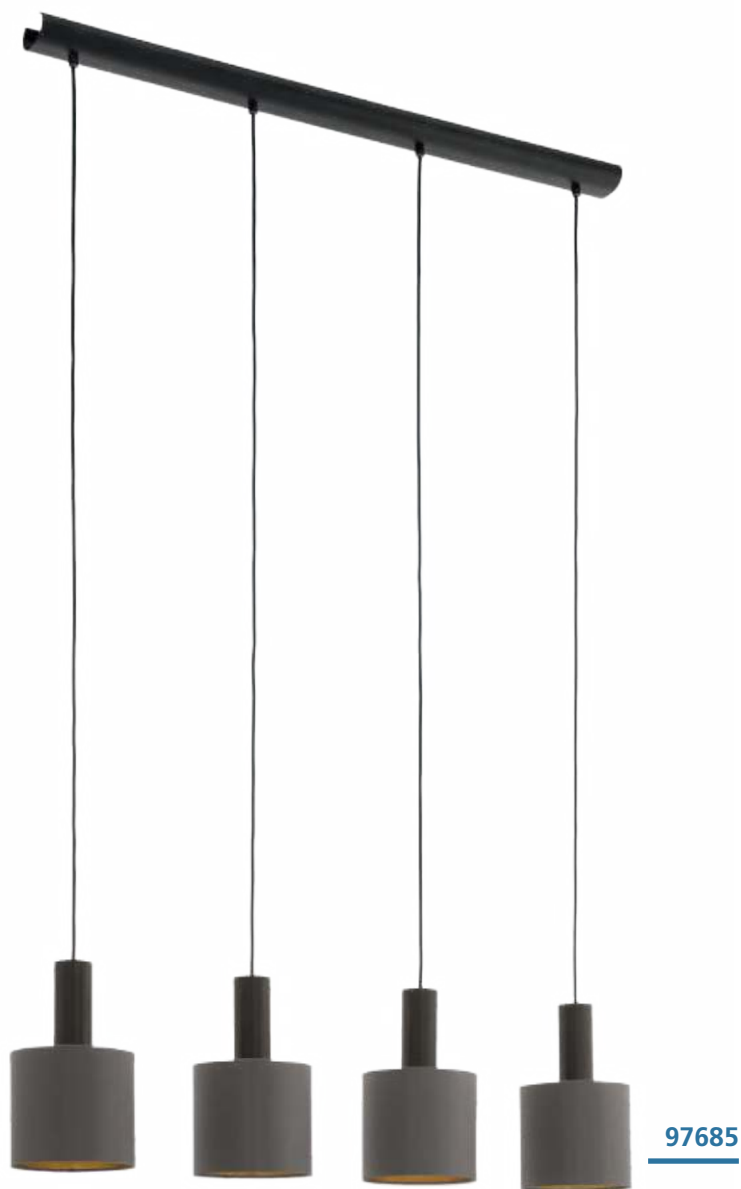

97685

97684 CONCESSA 1

pendant light; steel, dark brown / fabric, cappuccino, gold
 Hängeleuchte; Stahl, dunkelbraun / Textil, cappuccino, gold
 luminaire en suspension; acier, marron foncé / tissu, cappuccino, or

H 1500, Ø 420



E27



3x 60W



9 002759 976842



H 1500

Ø 420

97685 CONCESSA 1

pendant light; steel, dark brown / fabric, cappuccino, gold
 Hängeleuchte; Stahl, dunkelbraun / Textil, cappuccino, gold
 luminaire en suspension; acier, marron foncé / tissu, cappuccino, or

L 940, B 160, H 1500



E27



4x 60W



9 002759 976859

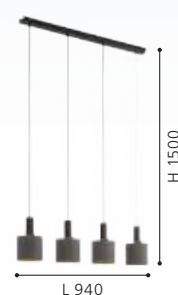

H 1500

L 940

DESIGN
HIGHLIGHT
DETAIL

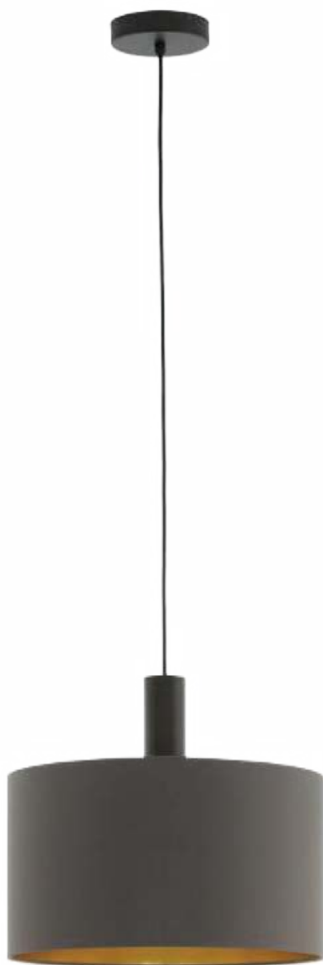

97682



97683

97682 CONCESSA 1

pendant light; steel, dark brown / fabric, cappuccino, gold
Hängeleuchte; Stahl, dunkelbraun / Textil, cappuccino, gold
luminaire en suspension; acier, marron foncé / tissu, cappuccino, or

H 1500, Ø 380



9 002759 976828



97683 CONCESSA 1

pendant light; steel, dark brown / fabric, cappuccino, gold
Hängeleuchte; Stahl, dunkelbraun / Textil, cappuccino, gold
luminaire en suspension; acier, marron foncé / tissu, cappuccino, or

H 1500, Ø 530

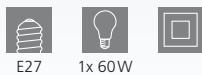

9 002759 976835



DESIGN
HIGHLIGHT
DETAIL



99445



99446



99445 ALBARIZA

pendant light; steel, wood, black, brown / fabric, cappuccino, gold

Hängeleuchte; Stahl, Holz, schwarz, braun / Textil, cappuccino, gold

luminaire en suspension; acier, bois, noir, marron / tissu, cappuccino, or

H 1100, Ø 160



E27

1x 40W



9 002759 994457



99446 ALBARIZA

pendant light; steel, wood, black, brown / fabric, cappuccino, gold

Hängeleuchte; Stahl, Holz, schwarz, braun / Textil, cappuccino, gold

luminaire en suspension; acier, bois, noir, marron / tissu, cappuccino, or

L 895, B 160, H 1100



E27

3x 40W



9 002759 994464

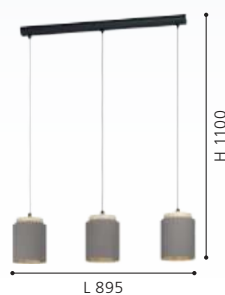

99447 ALBARIZA

pendant light; steel, wood, black, brown / fabric, cappuccino, gold

Hängeleuchte; Stahl, Holz, schwarz, braun / Textil, cappuccino, gold

luminaire en suspension; acier, bois, noir, marron / tissu, cappuccino, or

H 1500, Ø 700



E27

5x 40W



9 002759 994471

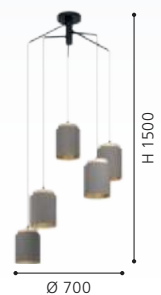



99447





99486

99487

99487 ALMEIDA 2

pendant light; steel, brushed brass / fabric, cappuccino, brass
 Hängeleuchte; Stahl, messing-gebürstet / Textil, cappuccino, messing
 luminaire en suspension; acier, laiton brossé / tissu, cappuccino, laiton

L 1200, B 155, H 1100



E14 5x 40W



9 002759 994877

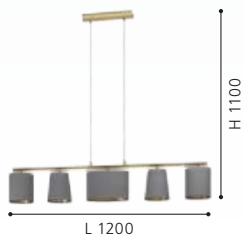

99486 ALMEIDA 2

ceiling light; steel, brushed brass / fabric, cappuccino, brass
 Deckenleuchte; Stahl, messing-gebürstet / Textil, cappuccino, messing
 plafonnier; acier, laiton brossé / tissu, cappuccino, laiton

L 810, B 155, H 280



E14 3x 40W



9 002759 994860

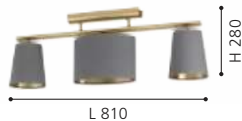

99612 ALMEIDA 2

floor light; steel, brushed brass / fabric, cappuccino, brass
 Stehleuchte; Stahl, messing-gebürstet / Textil, cappuccino, messing
 lampadaire; acier, laiton brossé / tissu, cappuccino, laiton

H 1670, Ø 320, Base: Ø 300

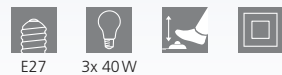

E27 3x 40W



9 002759 996123





99612

99611 ALMEIDA 2

table light; steel, brushed brass / fabric, cappuccino, brass
 Tischleuchte; Stahl, messing-gebürstet / Textil, cappuccino, messing
 luminaire de table; acier, laiton brossé / tissu, cappuccino, laiton

H 605, Ø 260, Base: Ø 200



E27



2x 40W



9 002759 996116



99611

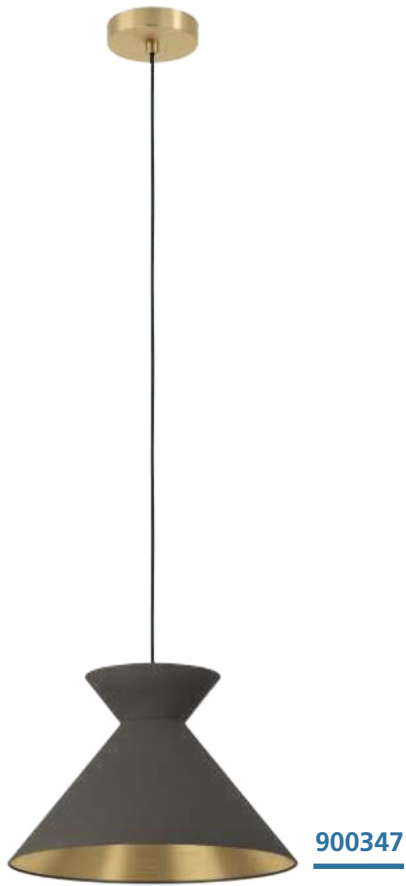

900347



900348



DESIGN
HIGHLIGHT
DETAIL

900347 NASTASIA

pendant light; steel, black / fabric, cappuccino, brass
Hängeleuchte; Stahl, schwarz / Textil, cappuccino, messing
luminaire en suspension; acier, noir / tissu, cappuccino, laiton

H 1100, Ø 380



E27 1x 40W



9 008606 238859



900348 NASTASIA

pendant light; steel, black / fabric, cappuccino, brass
Hängeleuchte; Stahl, schwarz / Textil, cappuccino, messing
luminaire en suspension; acier, noir / tissu, cappuccino, laiton

L 1000, B 240, H 1100



E27 3x 40W



9 008606 238866

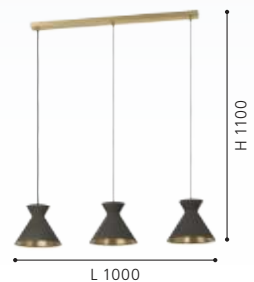



900376



900378



900377

900376 AGLIENTINA

pendant light; steel, brushed brass / fabric, white, brass
Hängeleuchte; Stahl, messing-gebürstet / Textil, weiss, messing
luminaire en suspension; acier, laiton brossé / tissu, blanc, laiton

H 1100, Ø 200



E27 1x 40W



9 008606 243587

900378 AGLIENTINA

floor light; steel, brushed brass / fabric, white, brass
Stehleuchte; Stahl, messing-gebürstet / Textil, weiss, messing
lampadaire; acier, laiton brossé / tissu, blanc, laiton

H 1700, Ø 200, Base: Ø 250



E27 1x 40W



9 008606 243600

900377 AGLIENTINA

pendant light; steel, brushed brass / fabric, white, brass
Hängeleuchte; Stahl, messing-gebürstet / Textil, weiss, messing
luminaire en suspension; acier, laiton brossé / tissu, blanc, laiton

L 900, B 200, H 1100



E27 3x 40W

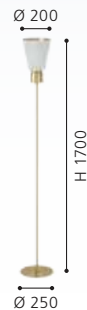

9 008606 243594

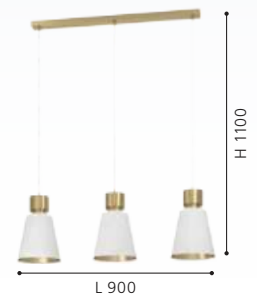



98587



98588



98587 ALMEIDA 1

pendant light; steel, black / fabric, grey, white
 Hängeleuchte; Stahl, schwarz / Textil, grau, weiss
 luminaire en suspension; acier, noir / tissu, gris, blanc

L 860, B 255, H 1100



E14



3x 25W

98588 ALMEIDA 1

pendant light; steel, black / fabric, black, grey, white
 Hängeleuchte; Stahl, schwarz / Textil, schwarz, grau, weiss
 luminaire en suspension; acier, noir / tissu, noir, gris, blanc

L 1200, B 255, H 1100



E14



5x 25W



9 002759 985875



9 002759 985882





95192



95194



94995

95192 ALMEIDA

ceiling light; steel, black / fabric, anthracite, white, brown
Deckenleuchte; Stahl, schwarz / Textil, anthrazit, weiss, braun
plafonnier; acier, noir / tissu, anthracite, blanc, marron

H 350, Ø 590

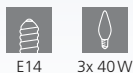

E14 3x 40W



9 002759 951924

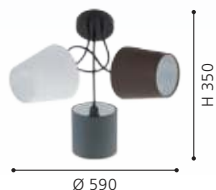

95194 ALMEIDA

table light; steel, black / fabric, white, anthracite
Tischleuchte; Stahl, schwarz / Textil, weiss, anthrazit
luminaire de table; acier, noir / tissu, blanc, anthracite

L 380, B 185, H 475, Base: Ø 155

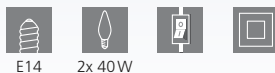

E14 2x 40W



9 002759 951948



94995 MARONDA

floor light; steel, black / fabric, anthracite, white, brown
Stehleuchte; Stahl, schwarz / Textil, anthrazit, weiss, braun
lampadaire; acier, noir / tissu, anthracite, blanc, marron

L 275, B 35, H 1520, Base: Ø 230

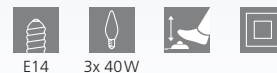

E14 3x 40W



9 002759 949952

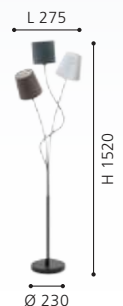

LIGHTING FAMILIES

WOOD LUMINAIRES
HOLZLEUCHTEN
LUMINAIRES À BOIS

SIMPLE CLASSINESS

The wood luminaires with their unusual designs are perfectly trendy and bring cosiness to every home. Our range of wood luminaires offers a great selection of various shapes, sizes and colours. It contains anything from suspended to table luminaires.

SCHLICHTE ELEGANZ

Die Holzleuchten mit ihrem außergewöhnlichen Design sind voll im Trend und sorgen für Gemütlichkeit in jedem Zuhause. Unser Sortiment an Holzleuchten bietet eine große Auswahl an verschiedenen Formen, Größen sowie Farben und reicht von der Hänge- bis hin zur Tischleuchte.



ÉLÉGANCE SIMPLE

Les luminaires en bois avec leur design extraordinaire sont très tendance et assurent un confort dans chaque maison. Notre gamme de luminaires en bois offre un grand choix de formes, de tailles et de couleurs différentes et s'étend des luminaires en suspension jusqu'aux luminaires de table.



OVERVIEW

LIGHTING FAMILIES / WOOD



VELASCO
p. 196-197

BAJAZZARA
p. 198-199

RUSTICARIA
p. 199

STELLATO 1
p. 200-201

STELLATO 2
p. 201-202

STELLATO 3
p. 203

TINDORI
p. 204-205

COSSANO
p. 205-207

COSSANO 2
p. 208

SENDERO
p. 210-211



This product is available in different colors and shapes./ Dieser Artikel ist in unterschiedlichen Farben und Formen verfügbar.
Cet article est disponible en différentes couleurs et formes.

WOOD MATERIALS

LAMELLA SHADES



wood, white
Holz, weiß
bois, blanc



wood, brown
Holz, braun
bois, marron



wood, maple
Holz, ahorn
bois, érable



wood, maple
Holz, ahorn
bois, érable



wood, brown
Holz, braun
bois, marron



wood, black
Holz, schwarz
bois, noir



wood, grey
Holz, grau
bois, gris



wood, nut
Holz, nuss
bois, noix



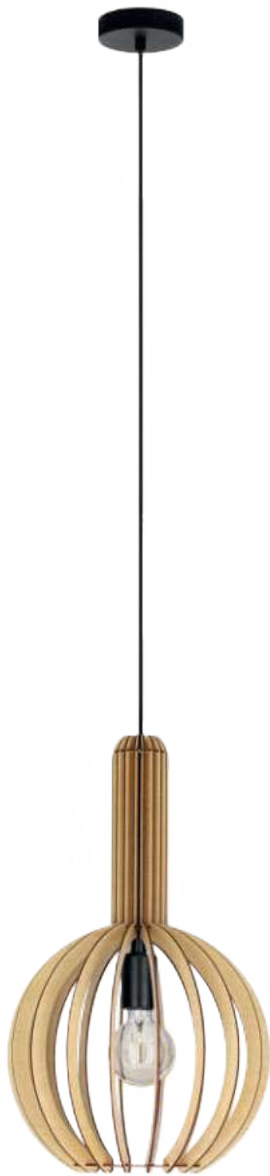

900151



900152



900153

900151 VELASCO

pendant light; steel, black / wood, maple
Hängeleuchte; Stahl, schwarz / Holz, ahorn
luminaire en suspension; acier, noir / bois, érable

H 1100, Ø 310



E27 1x 40W



9 008606 224043

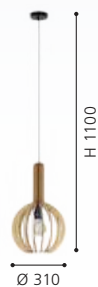

900152 VELASCO

pendant light; steel, black / wood, maple
Hängeleuchte; Stahl, schwarz / Holz, ahorn
luminaire en suspension; acier, noir / bois, érable

H 1100, Ø 380



E27 1x 40W



9 008606 224050



900153 VELASCO

pendant light; steel, black / wood, black
Hängeleuchte; Stahl, schwarz / Holz, schwarz
luminaire en suspension; acier, noir / bois, noir

H 1100, Ø 310



E27 1x 40W



9 008606 224067





900154



900154 VELASCO

pendant light; steel, black / wood, black
Hängeleuchte; Stahl, schwarz / Holz, schwarz
luminaire en suspension; acier, noir / bois, noir

H 1100, Ø 380



E27



1x 40W



9 008606 224074





900503



900502



900504

900503 BAJAZZARA

pendant light; steel, black / wood, grey
Hängeleuchte; Stahl, schwarz / Holz, grau
luminaire en suspension; acier, noir / bois, gris

L 890, B 190, H 1100



E27



3x 40W



9 008606 244331



L 890

H 1100

900502 BAJAZZARA

pendant light; steel, black / wood, grey
Hängeleuchte; Stahl, schwarz / Holz, grau
luminaire en suspension; acier, noir / bois, gris

H 1100, Ø 260



E27



1x 40W



9 008606 244324



Ø 260

H 1100

900504 BAJAZZARA

pendant light; steel, black / wood, black
Hängeleuchte; Stahl, schwarz / Holz, schwarz
luminaire en suspension; acier, noir / bois, noir

H 1100, Ø 260



E27



1x 40W



9 008606 244348



Ø 260

H 1100



900505



900385



900386



900505 BAJAZZARA

pendant light; steel, black / wood, black
Hängeleuchte; Stahl, schwarz / Holz, schwarz
luminaire en suspension; acier, noir / bois, noir

L 890, B 190, H 1100



E27 3x 40W



9 008606 244355



L 890

H 1100

900385 RUSTICARIA

ceiling light; steel, black / wood, glass, brown, white
Deckenleuchte; Stahl, schwarz / Holz, Glas, braun, weiss
plafonnier; acier, noir / bois, verre, marron, blanc

H 275, Ø 450



E27 1x 40W



9 008606 240036



Ø 450

H 275

900386 RUSTICARIA

pendant light; steel, black / wood, glass, brown, white
Hängeleuchte; Stahl, schwarz / Holz, Glas, braun, weiss
luminaire en suspension; acier, noir / bois, verre, marron, blanc

H 1100, Ø 450



E27 1x 40W



9 008606 240043



Ø 450

H 1100



95599



95598



95602

95599 STELLATO 1

pendant light; steel, satin nickel / wood, glass, maple, white
 Hängeleuchte; Stahl, nickel-matt / Holz, Glas, ahorn, weiss
 luminaire en suspension; acier, nickel mat / bois, verre, érable, blanc

H 1500, Ø 500



9 002759 955991



95598 STELLATO 1

pendant light; steel, satin nickel / wood, glass, maple, white
 Hängeleuchte; Stahl, nickel-matt / Holz, Glas, ahorn, weiss
 luminaire en suspension; acier, nickel mat / bois, verre, érable, blanc

H 1300, Ø 400



9 002759 955984



95602 STELLATO 1

wall light; steel, white / wood, glass, maple, white
 Wandleuchte; Stahl, weiss / Holz, Glas, ahorn, weiss
 applique; acier, blanc / bois, verre, érable, blanc

L 285, H 250, A 140



9 002759 956028

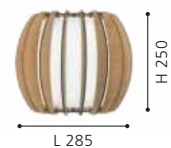



95597



STELLATO 1
STELLATO 2



95606



95607

95597 STELLATO 1

ceiling light; steel, satin nickel / wood, glass, maple, white
Deckenleuchte; Stahl, nickel-matt / Holz, Glas, ahorn, weiss
plafonnier; acier, nickel mat / bois, verre, érable, blanc

H 275, Ø 400

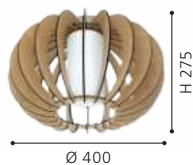

95606 STELLATO 2

pendant light; steel, white / wood, glass, white
Hängeleuchte; Stahl, weiss / Holz, Glas, weiss
luminaire en suspension; acier, blanc / bois, verre, blanc

H 1300, Ø 400

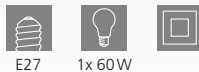

95607 STELLATO 2

pendant light; steel, white / wood, glass, white
Hängeleuchte; Stahl, weiss / Holz, Glas, weiss
luminaire en suspension; acier, blanc / bois, verre, blanc

H 1500, Ø 500





DESIGN
HIGHLIGHT
DETAIL

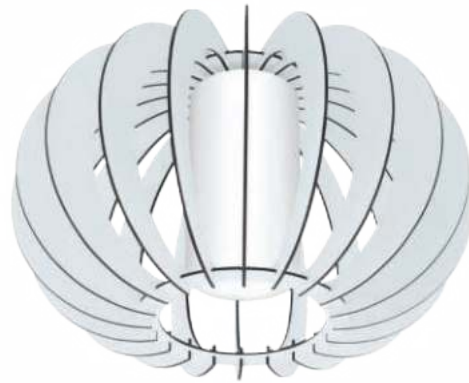

95605



95609



EGLO
RECOMMENDS
110033

STELLATO 2
STELLATO 3

95609 STELLATO 2

wall light; steel, white / wood, glass, white
Wandleuchte; Stahl, weiss / Holz, Glas, weiss
applique; acier, blanc / bois, verre, blanc

L 285, H 250, A 140



E27



1x 60W



9 002759 956097

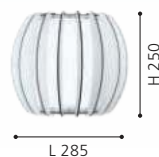

L 285

H 250

95605 STELLATO 2

ceiling light; steel, white / wood, glass, white
Deckenleuchte; Stahl, weiss / Holz, Glas, weiss
plafonnier; acier, blanc / bois, verre, blanc

H 275, Ø 400



E27



1x 60W



9 002759 956059

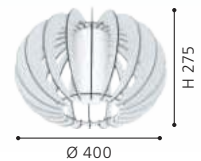

Ø 400

H 275



95591



95589



95594

95591 STELLATO 3

pendant light; steel, satin nickel / wood, glass, brown, white
 Hängeleuchte; Stahl, nickel-matt / Holz, Glas, braun, weiss
 luminaire en suspension; acier, nickel mat / bois, verre, marron, blanc

H 1300, Ø 400

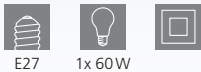

9 002759 955915



95589 STELLATO 3

ceiling light; steel, satin nickel / wood, glass, brown, white
 Deckenleuchte; Stahl, nickel-matt / Holz, Glas, braun, weiss
 plafonnier; acier, nickel mat / bois, verre, marron, blanc

H 275, Ø 400



9 002759 955892



95594 STELLATO 3

wall light; steel, white / wood, glass, brown, white
 Wandleuchte; Stahl, weiss / Holz, Glas, braun, weiss
 applique; acier, blanc / bois, verre, marron, blanc

L 285, H 250, A 140



9 002759 955946

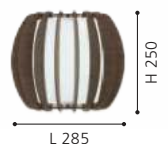



96211 | 96214

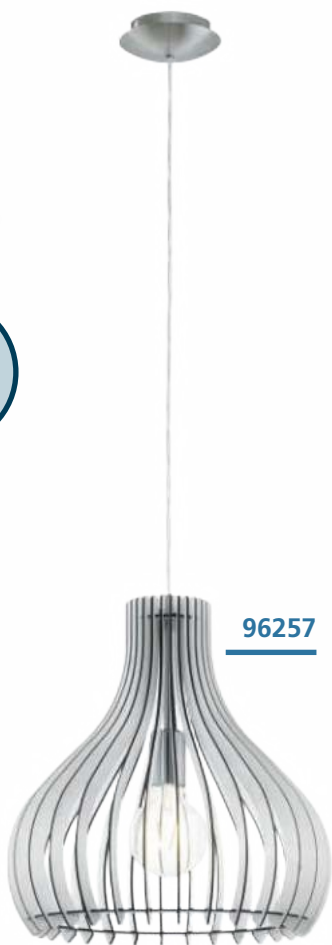

96257

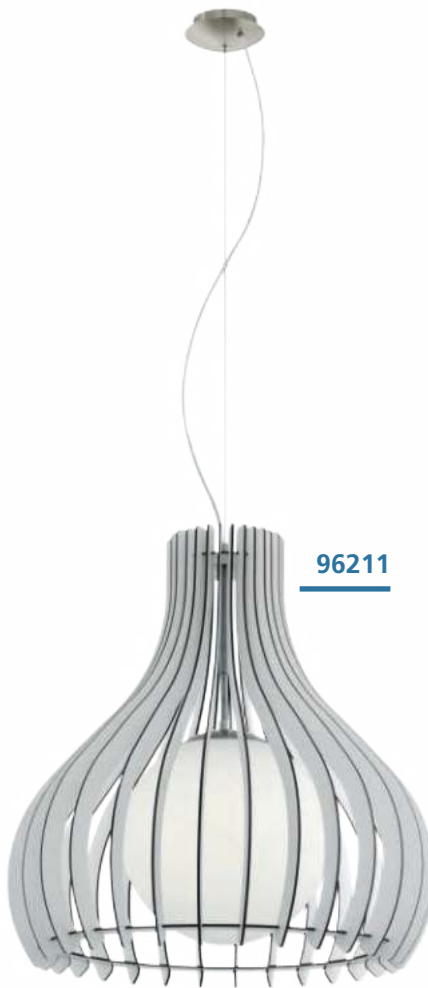

96211



96258

96257 TINDORI

pendant light; steel, satin nickel / wood, white
Hängeleuchte; Stahl, nickel-matt / Holz, weiss
luminaire en suspension; acier, nickel mat / bois, blanc

H 1300, Ø 380

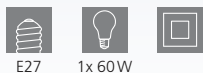

9 002759 962579



96211 TINDORI

pendant light; steel, satin nickel / wood, glass, white
Hängeleuchte; Stahl, nickel-matt / Holz, Glas, weiss
luminaire en suspension; acier, nickel mat / bois, verre, blanc

H 1500, Ø 500



9 002759 962111



96258 TINDORI

pendant light; steel, satin nickel / wood, maple
Hängeleuchte; Stahl, nickel-matt / Holz, ahorn
luminaire en suspension; acier, nickel mat / bois, érable

H 1300, Ø 380



9 002759 962586





96214



94438



94442

96214 TINDORI

pendant light; steel, satin nickel / wood, glass, maple, white
 Hängeleuchte; Stahl, nickel-matt / Holz, Glas, ahorn, weiss
 luminaire en suspension; acier, nickel mat / bois, verre, érable, blanc

H 1500, Ø 500



9 002759 962142



H 1500

Ø 500

94438 COSSANO

pendant light; steel, white / wood, white
 Hängeleuchte; Stahl, weiss / Holz, weiss
 luminaire en suspension; acier, blanc / bois, blanc

H 1300, Ø 300

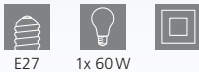

9 002759 944384



H 1300

Ø 300

94442 COSSANO

pendant light; steel, white / wood, white
 Hängeleuchte; Stahl, weiss / Holz, weiss
 luminaire en suspension; acier, blanc / bois, blanc

H 1500, Ø 450

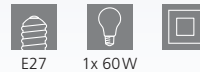

9 002759 944421



H 1500

Ø 450



94635 COSSANO

pendant light; steel, satin nickel / wood, brown
 Hängeleuchte; Stahl, nickel-matt / Holz, braun
 luminaire en suspension; acier, nickel mat / bois, marron

H 1300, Ø 300



94636 COSSANO

pendant light; steel, satin nickel / wood, brown
 Hängeleuchte; Stahl, nickel-matt / Holz, braun
 luminaire en suspension; acier, nickel mat / bois, marron

H 1500, Ø 500

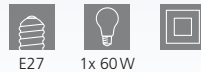

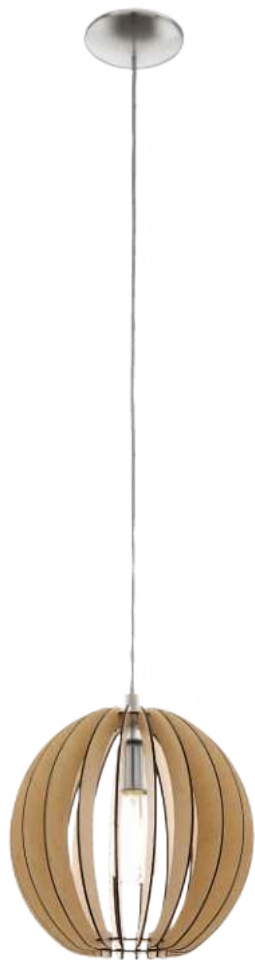

94764



94765



94767

94764 COSSANO

pendant light; steel, satin nickel / wood, maple
Hängeleuchte; Stahl, nickel-matt / Holz, ahorn
luminaire en suspension; acier, nickel mat / bois, érable

H 1300, Ø 300

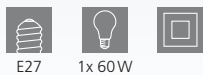

E27 1x 60W



94765 COSSANO

pendant light; steel, satin nickel / wood, maple
Hängeleuchte; Stahl, nickel-matt / Holz, ahorn
luminaire en suspension; acier, nickel mat / bois, érable

H 1500, Ø 500

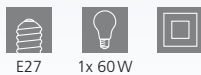

E27 1x 60W



94767 COSSANO

pendant light; steel, satin nickel / wood, maple
Hängeleuchte; Stahl, nickel-matt / Holz, ahorn
luminaire en suspension; acier, nickel mat / bois, érable

H 1500, Ø 450

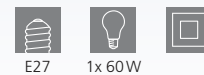

E27 1x 60W



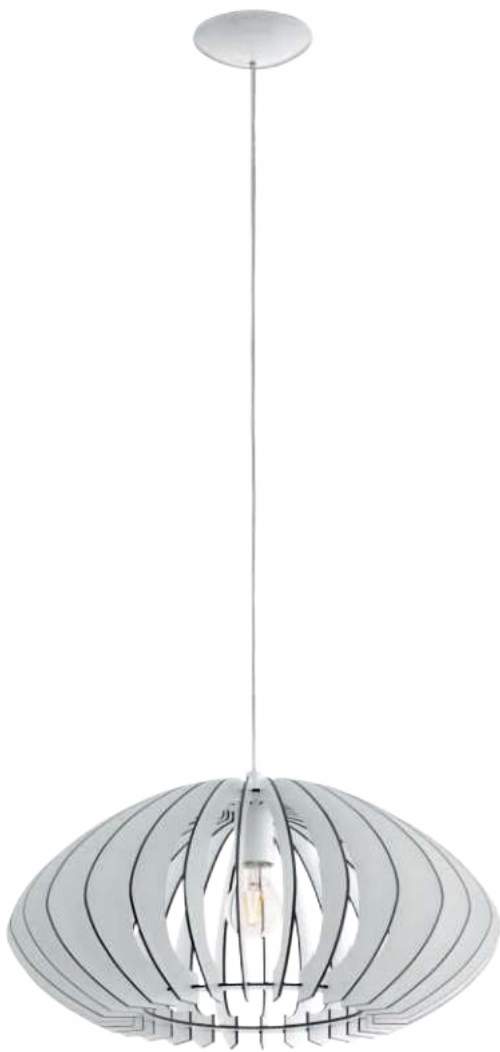

95254

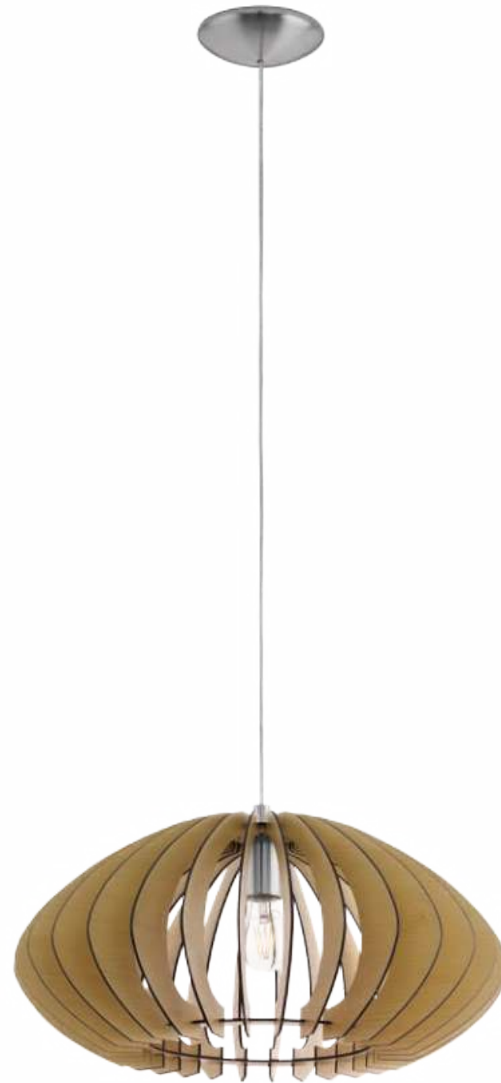

95257

95254 COSSANO 2

pendant light; steel, white / wood, white
 Hängeleuchte; Stahl, weiss / Holz, weiss
 luminaire en suspension; acier, blanc / bois, blanc

H 1500, Ø 500



95257 COSSANO 2

pendant light; steel, satin nickel / wood, maple
 Hängeleuchte; Stahl, nickel-matt / Holz, ahorn
 luminaire en suspension; acier, nickel mat / bois, érable

H 1500, Ø 500

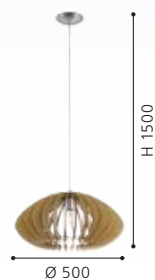
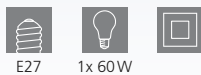

95261 COSSANO 2

pendant light; steel, satin nickel / wood, dark brown
 Hängeleuchte; Stahl, nickel-matt / Holz, dunkelbraun
 luminaire en suspension; acier, nickel mat / bois, marron foncé

H 1500, Ø 500

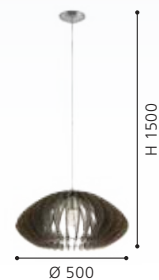



95261





96194



96195



96193

96194 SENDERO

pendant light; steel, satin nickel / wood, maple
Hängeleuchte; Stahl, nickel-matt / Holz, ahorn
luminaire en suspension; acier, nickel mat / bois, érable

L 775, B 250, H 1300

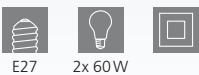

96193 SENDERO

pendant light; steel, satin nickel / wood, maple
Hängeleuchte; Stahl, nickel-matt / Holz, ahorn
luminaire en suspension; acier, nickel mat / bois, érable

H 1300, Ø 450



96195 SENDERO

wall light; steel, white / wood, maple
Wandleuchte; Stahl, weiss / Holz, ahorn
applique; acier, blanc / bois, érable

L 240, H 220, A 120

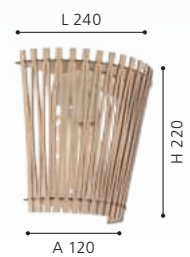



96199



96201

96199 SENDERO

pendant light; steel, satin nickel / wood, brown
 Hängeleuchte; Stahl, nickel-matt / Holz, braun
 luminaire en suspension; acier, nickel mat / bois, marron

H 1300, Ø 450



9 002759 961992



96201 SENDERO

pendant light; steel, satin nickel / wood, brown
 Hängeleuchte; Stahl, nickel-matt / Holz, braun
 luminaire en suspension; acier, nickel mat / bois, marron

L 775, B 250, H 1300

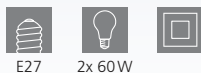

9 002759 962012



LIGHTING FAMILIES

STANDARD LUMINAIRES
STANDARD LEUCHTEN
LUMINAIRES STANDARD

FAMILY MEETING

This range combines ceiling, wall, suspended, floor and table luminaires. Give your rooms a consistent and stylish all-round illumination.

FAMILIENTREFFEN

Dieses Sortiment vereint sowohl Decken-, Wand- und Hängeleuchten als auch Tisch- und Stehleuchten. Verleihen Sie Ihren Räumlichkeiten eine einheitliche und stilvolle Rundumbeleuchtung.



RENCONTRE FAMILIALE

Cette gamme réunit aussi bien des plafonniers, des éclairages muraux, des éclairages suspendus que des lampes de table et des lampadaires. Donnez à vos pièces un éclairage d'ensemble unifié et riche en style.



OVERVIEW

LIGHTING FAMILIES / STANDARD

 TURALDO p.216	 LIBERTAD p.218, 220	 LIBERTAD 1 p.219	 CAMACHO p.222-223	 BOYAL p.224-227	 PANAGRIA p.228-229	 CANTERRAS p.230-231	 ABREOSA p.232
 CASIBARE p.234-235	 CREMELLA p.236-237	 ROMAZZINA p.238-241	 VENEZUELA p.242-243	 ESCANDIDOS p.244-245	 LURONE p.246-247	 NARICES p.248-249	 ERSEKA p.250-251
 MANZANARES p.252-253	 RONDO p.254-255	 RONDO 3 p.256	 OPTICA p.258-260	 GOROSIBA 1 p.262	 GOROSIBA p.262-263	 PINTO TEXTIL 1 p.264	 PINTO TEXTIL p.266-267
 PINTO NERO p.268	 PINTO GOLD p.270-271	 PINTO p.272-273	 TROY 3 p.274-275	 RIVATO p.276-277	 AMADORA p.278	 BAYMAN p.279	 VINOVO p.280
 MURCIA p.280-281	 SAVOY p.282-283	 MARBELLA p.284-285	 ERVIDEL p.286-287	 CLAVELLINA p.288-289	 ISIDRO p.290-291	 CARANACOA p.292-293	 BANDERILLAS p.294-295
 ALAMEDILLA p.294	 CODRIALES p.296-297	 SIBERIA p.298-299	 LEJIAS p.300-301	 LASANA 1 p.302, 307	 LASANA 2 p.302-303	 LASANA 3 p.304-305	 LASANA p.306



This product is available in different colors and shapes./ Dieser Artikel ist in unterschiedlichen Farben und Formen verfügbar.
Cet article est disponible en différentes couleurs et formes.



TARANDELL
p. 307



RONCADE 1
p. 308



SELVINA 1
p. 308



RONCADE
p. 309, 313



SELVINA
p. 309-310, 312



VALMORA
p. 310-311



NEVADO
p. 311



PALOZZA 1
p. 312



PALOZZA
p. 314-315





DESIGN
HIGHLIGHT
DETAIL



99077



99079

99077 TURALDO

ceiling light; wood, brown
Deckenleuchte; Holz, braun
plafonnier; bois, marron

H 80, Ø 70

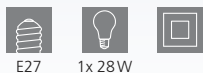

E27 1x 28W



9 002759 990770

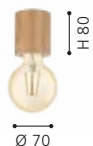

H 80

Ø 70

99079 TURALDO

table light; wood, brown
Tischleuchte; Holz, braun
luminaire de table; bois, marron

H 100, Ø 85



E27 1x 28W



9 002759 990794



H 100

Ø 85

99078 TURALDO

pendant light; wood, steel, brown, black
Hängeleuchte; Holz, Stahl, braun, schwarz
luminaire en suspension; bois, acier, marron, noir

H 1100, Ø 105



E27 1x 28W



9 002759 990787



H 1100

Ø 105



99078

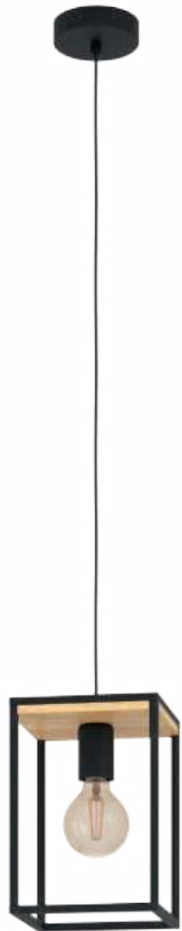

99795

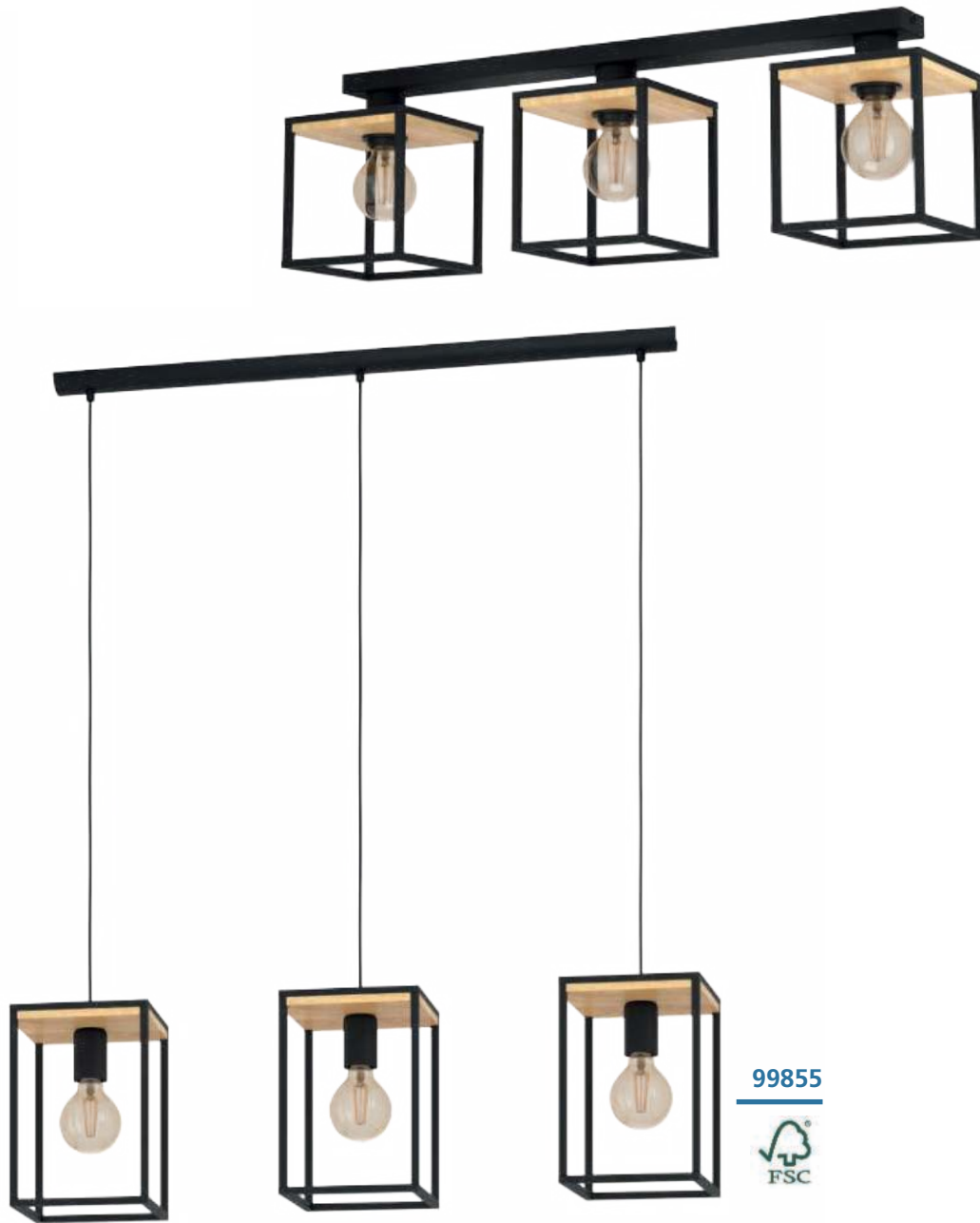

99856



99855



99795 LIBERTAD

pendant light; steel, wood, black, brown
Hängeleuchte; Stahl, Holz, schwarz, braun
luminaire en suspension; acier, bois, noir, marron

L 180, B 180, H 1100



E27

1x 40W



9 002759 997953



99855 LIBERTAD

pendant light; steel, wood, black, brown
Hängeleuchte; Stahl, Holz, schwarz, braun
luminaire en suspension; acier, bois, noir, marron

L 880, B 180, H 1100



E27

3x 40W



9 002759 998554



99856 LIBERTAD

ceiling light; steel, wood, black, brown
Deckenleuchte; Stahl, Holz, schwarz, braun
plafonnier; acier, bois, noir, marron

L 860, B 180, H 240



E27

3x 40W



9 002759 998561





900349



900349 LIBERTAD 1

pendant light; steel, wood, black, brown
 Hängeleuchte; Stahl, Holz, schwarz, braun
 luminaire en suspension; acier, bois, noir, marron

L 760, B 140, H 1100



E27



3x 40W



9 008606 243501

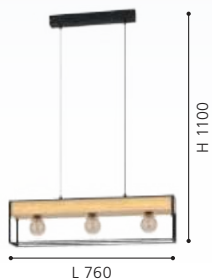

900349

The flower pots are included with this luminaire.

Bei dieser Leuchte sind die Blumentöpfe inkludiert.

Les pots de fleurs sont inclus avec ce luminaire.





99796



99798



99796 LIBERTAD

wall light; steel, wood, black, brown
Wandleuchte; Stahl, Holz, schwarz, braun
applique; acier, bois, noir, marron

L 140, H 240, A 165



E27 1x 40W



9 002759 997960



99798 LIBERTAD

floor light; steel, wood, black, brown
Stehleuchte; Stahl, Holz, schwarz, braun
lampadaire; acier, bois, noir, marron

L 180, B 180, H 1285

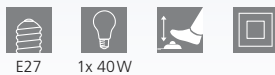

E27 1x 40W



9 002759 997984

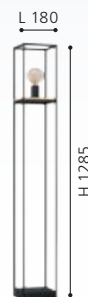

99797 LIBERTAD

table light; steel, wood, black, brown
Tischleuchte; Stahl, Holz, schwarz, braun
luminaire de table; acier, bois, noir, marron

L 140, B 140, H 350

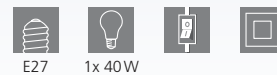

E27 1x 40W



9 002759 997977





99797





99293 CAMACHO

pendant light; steel, wood, black, brown / plastic, white
 Hängeleuchte; Stahl, Holz, schwarz, braun / Kunststoff, weiss
 luminaire en suspension; acier, bois, noir, marron / plastique, blanc

L 1100, B 60, H 1100

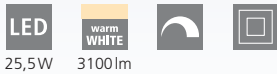

25,5W 3100lm



9 002759 992934

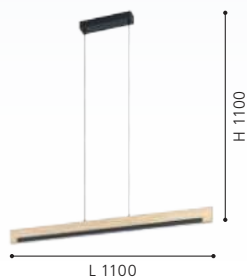

99292 CAMACHO

ceiling light; steel, wood, black, brown / plastic, white
 Deckenleuchte; Stahl, Holz, schwarz, braun / Kunststoff, weiss
 plafonnier; acier, bois, noir, marron / plastique, blanc

L 940, B 80, H 115



2x 10W 2600lm



9 002759 992927

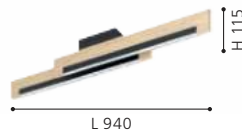

99294 CAMACHO

wall light; steel, wood, black, brown / plastic, white
 Wandleuchte; Stahl, Holz, schwarz, braun / Kunststoff, weiss
 applique; acier, bois, noir, marron / plastique, blanc

L 440, H 105, A 75



1x 9,6W 1050lm



9 002759 992941



TOUCH
ME



99296



99295



99295, 99296

These luminaires can be switched on and off by touching the specially designed "Touch Me" part of the fixture.

Diese Leuchten können ein- und ausgeschaltet werden, indem man sie an den dafür vorgesehenen "Touch Me" Bereichen berührt.

Ces luminaires peuvent être éteints et allumés simplement en touchant la partie spécialement conçue pour "Touch Me" du luminaire.

99296 CAMACHO

floor light; steel, wood, black, brown / plastic, white
Stehleuchte; Stahl, Holz, schwarz, braun / Kunststoff, weiss
lampadaire; acier, bois, noir, marron / plastique, blanc

L 75, B 20, H 1260, Base: B 250, T 200



19,5 W



2400lm



9 002759 992965

99295 CAMACHO

table light; steel, wood, black, brown / plastic, white
Tischleuchte; Stahl, Holz, schwarz, braun / Kunststoff, weiss
luminaire de table; acier, bois, noir, marron / plastique, blanc

L 75, B 20, H 405, Base: B 150, T 130



1x 6,5 W



800lm



9 002759 992958



99624 BOYAL

pendant light; steel, wood, black, brown rustic / plastic, white
 Hängeleuchte; Stahl, Holz, schwarz, braun rustikal / Kunststoff, weiss
 luminaire en suspension; acier, bois, noir, marron rustique / plastique, blanc

L 1010, B 400, H 1100

LED warm WHITE 2x 12,5W 3600lm LED warm WHITE 1x 15,5W 2250lm

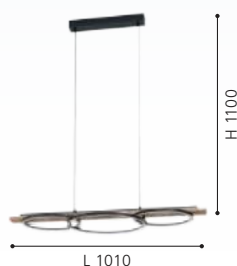

99413 BOYAL

ceiling light; steel, wood, black, brown rustic / plastic, white
 Deckenleuchte; Stahl, Holz, schwarz, braun rustikal / Kunststoff, weiss
 plafonnier; acier, bois, noir, marron rustique / plastique, blanc

L 1010, B 400, H 95

LED warm WHITE 2x 12W 3400lm LED warm WHITE 1x 12W 1700lm





99353



99457

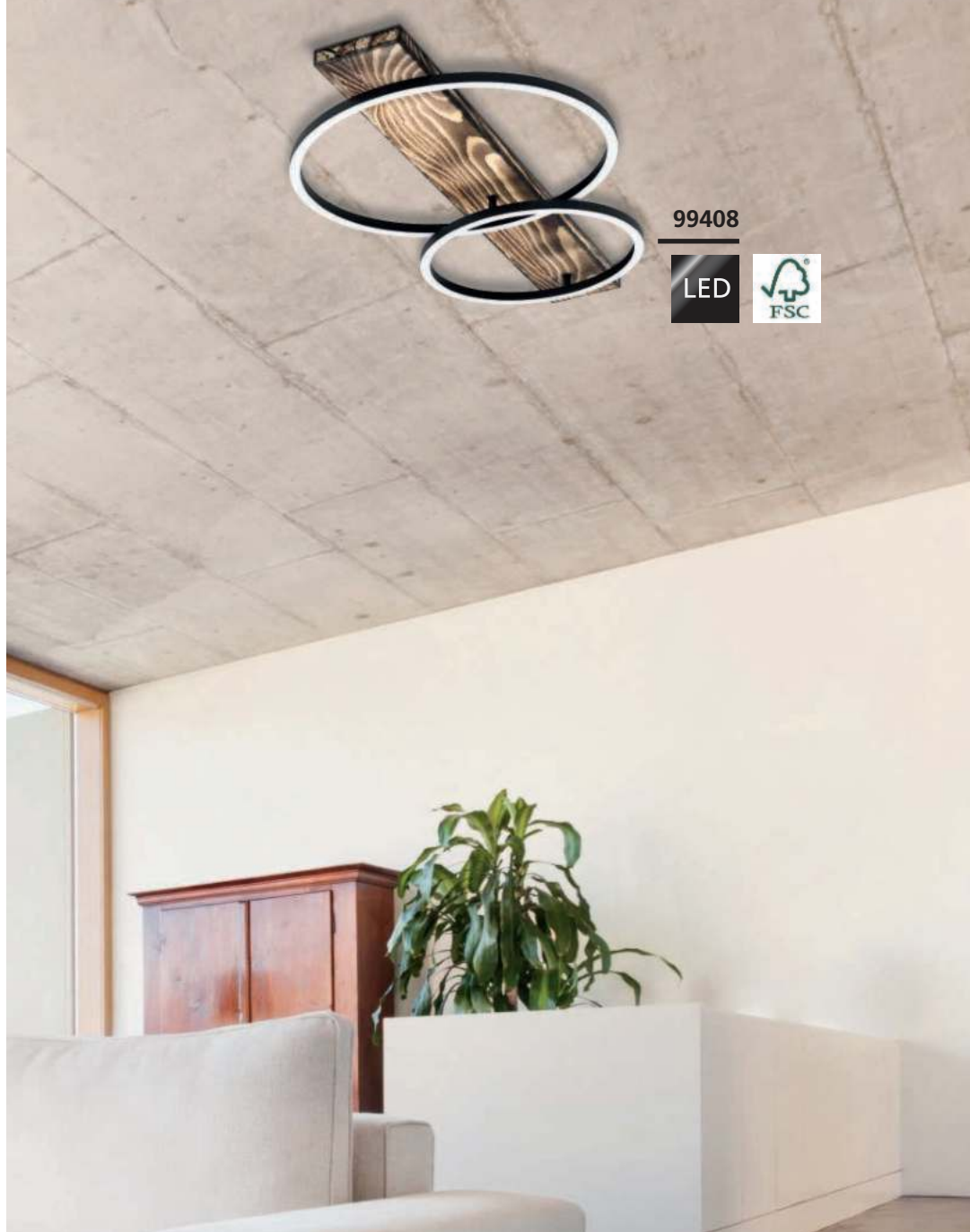

99408



99353 BOYAL

wall light; steel, wood, black, brown rustic / plastic, white
Wandleuchte; Stahl, Holz, schwarz, braun rustikal / Kunststoff, weiss
applique; acier, bois, noir, marron rustique / plastique, blanc

L 300, H 560, A 75



1x 12W 1700lm



9 002759 993535



99457 BOYAL

table light; steel, wood, black, brown rustic / plastic, white
Tischleuchte; Stahl, Holz, schwarz, braun rustikal / Kunststoff, weiss
luminaire de table; acier, bois, noir, marron rustique / plastique, blanc

L 300, B 150, H 425, Base: B 110, T 150



1x 12W 1700lm



9 002759 994570



99408 BOYAL

ceiling light; steel, wood, black, brown rustic / plastic, white
Deckenleuchte; Stahl, Holz, schwarz, braun rustikal / Kunststoff, weiss
plafonnier; acier, bois, noir, marron rustique / plastique, blanc

L 780, B 400, H 90



1x 12W 1700lm 1x 12W 1700lm



9 002759 994082





99625 BOYAL

pendant light; steel, black, brown / plastic, white
 Hängeleuchte; Stahl, schwarz, braun / Kunststoff, weiss
 luminaire en suspension; acier, noir, marron / plastique, blanc

L 1010, B 400, H 1100

LED warm WHITE LED warm WHITE

2x 12,5W 3600lm 1x 15,5W 2250lm



9 002759 996253

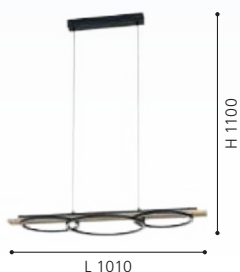

99468 BOYAL

ceiling light; steel, wood, black, brown / plastic, white
 Deckenleuchte; Stahl, Holz, schwarz, braun / Kunststoff, weiss
 plafonnier; acier, bois, noir, marron / plastique, blanc

L 1010, B 400, H 95

LED warm WHITE LED warm WHITE

2x 12W 3400lm 1x 12W 1700lm



9 002759 994686

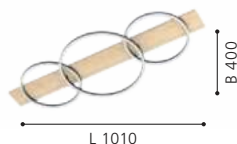

99467 BOYAL

ceiling light; steel, wood, black, brown / plastic, white
 Deckenleuchte; Stahl, Holz, schwarz, braun / Kunststoff, weiss
 plafonnier; acier, bois, noir, marron / plastique, blanc

L 780, B 400, H 90

LED warm WHITE LED warm WHITE

1x 12W 1700lm 1x 12W 1700lm



9 002759 994679

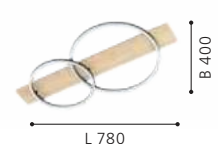



99469

LED



99466

LED

99469 BOYAL

table light; steel, wood, black, brown / plastic, white
Tischleuchte; Stahl, Holz, schwarz, braun / Kunststoff, weiss
luminaire de table; acier, bois, noir, marron / plastique, blanc

L 300, B 150, H 425, Base: B 110, T 150



1x 12W 1700lm



9 002759 994693



99466 BOYAL

wall light; steel, wood, black, brown / plastic, white
Wandleuchte; Stahl, Holz, schwarz, braun / Kunststoff, weiss
applique; acier, bois, noir, marron / plastique, blanc

L 300, H 560, A 75



1x 12W 1700lm



9 002759 994662

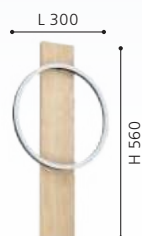



900489



900488



900491



900489 PANAGRIA

pendant light; aluminium, steel, wood, black, brown / plastic, white

Hängeleuchte; Alu, Stahl, Holz, schwarz, braun / Kunststoff, weiss

luminaire en suspension; aluminium, acier, bois, noir, marron / plastique, blanc

L 935, B 75, H 1100



2x 13W 3120lm



9 008606 244249

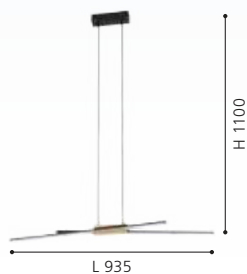

900488 PANAGRIA

ceiling light; aluminium, steel, wood, black, brown / plastic, white

Deckenleuchte; Alu, Stahl, Holz, schwarz, braun / Kunststoff, weiss

plafonnier; aluminium, acier, bois, noir, marron / plastique, blanc

L 935, B 75, H 110



2x 13W 3120lm



9 008606 244232



900491 PANAGRIA

wall light; aluminium, steel, wood, black, brown / plastic, white

Wandleuchte; Alu, Stahl, Holz, schwarz, braun / Kunststoff, weiss

applique; aluminium, acier, bois, noir, marron / plastique, blanc

L 75, H 540, A 85



2x 6,3W 1510lm



9 008606 244256



DESIGN
HIGHLIGHT
DETAIL



900492



900493



900492 PANAGRIA

table light; aluminium, steel, wood, black, brown / plastic, white
Tischleuchte; Alu, Stahl, Holz, schwarz, braun / Kunststoff, weiss
luminaire de table; aluminium, acier, bois, noir, marron /
plastique, blanc

L 75, B 45, H 455, Base: B 100, T 100



1x 6,8W 1440lm 1x 5,2W



9 008606 244263



900493 PANAGRIA

floor light; aluminium, steel, wood, black, brown / plastic, white
Stehleuchte; Alu, Stahl, Holz, schwarz, braun / Kunststoff, weiss
lampadaire; aluminium, acier, bois, noir, marron / plastique,
blanc

L 85, B 75, H 1460, Base: B 160, T 160

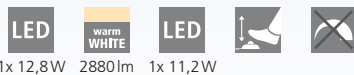

1x 12,8W 2880lm 1x 11,2W



9 008606 244270

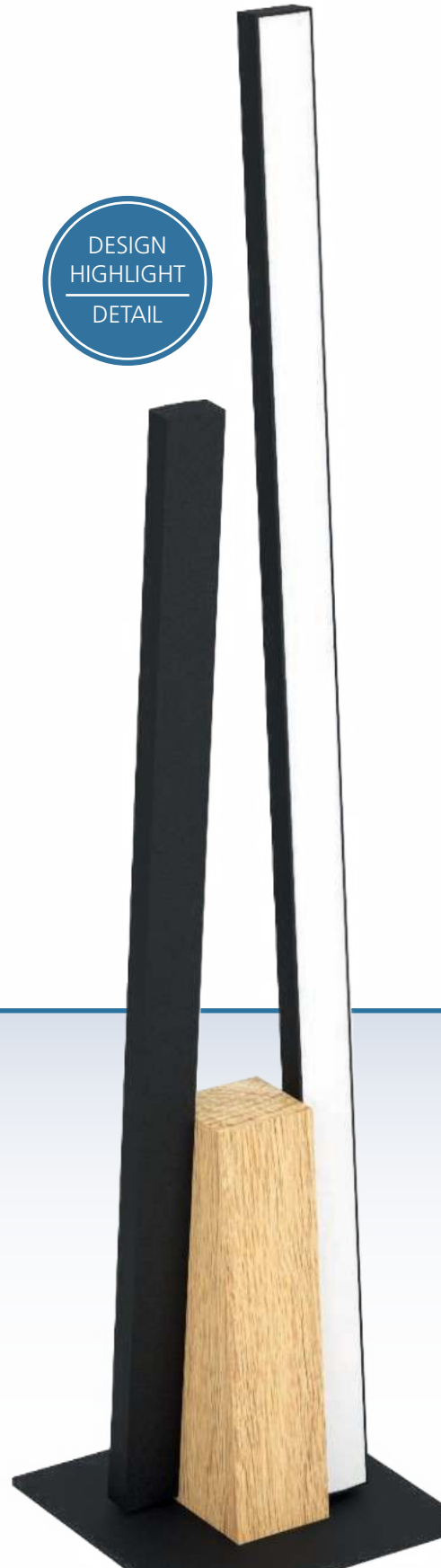



99545



99544

99545 CANTERRAS

pendant light; steel, black / terrazzo, grey, white
 Hängeleuchte; Stahl, schwarz / Terrazzo, grau, weiss
 luminaire en suspension; acier, noir / terrazzo, gris, blanc

L 975, B 150, H 1100



99544 CANTERRAS

pendant light; steel, black / terrazzo, grey, white
 Hängeleuchte; Stahl, schwarz / Terrazzo, grau, weiss
 luminaire en suspension; acier, noir / terrazzo, gris, blanc

H 1100, Ø 150

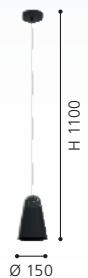



99546



99547



99546 CANTERRAS

wall light; steel, black / terrazzo, grey, white
 Wandleuchte; Stahl, schwarz / Terrazzo, grau, weiss
 applique; acier, noir / terrazzo, gris, blanc

L 150, H 320, A 275



9 002759 995461



99547 CANTERRAS

floor light; steel, black / terrazzo, grey, white
 Stehleuchte; Stahl, schwarz / Terrazzo, grau, weiss
 lampadaire; acier, noir / terrazzo, gris, blanc

L 430, B 150, H 1785, Base: Ø 300

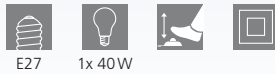

9 002759 995478





99513



99512

99513 ABREOSA

floor light; steel, black, grey
Stehleuchte; Stahl, schwarz, grau
lampadaire; acier, noir, gris

L 370, B 280, H 1510, Base: Ø 250

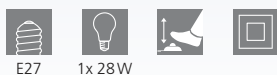

E27 1x 28W



9 002759 995133

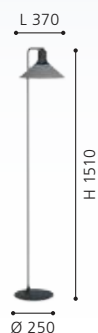

99512 ABREOSA

pendant light; steel, black, grey
Hängeleuchte; Stahl, schwarz, grau
luminaire en suspension; acier, noir, gris

L 1080, B 280, H 1100



E27 3x 28W



9 002759 995126



99511 ABREOSA

pendant light; steel, black, grey
Hängeleuchte; Stahl, schwarz, grau
luminaire en suspension; acier, noir, gris

H 1100, Ø 280



E27 1x 28W



9 002759 995119

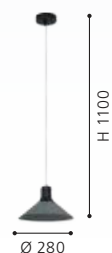

99511





99551

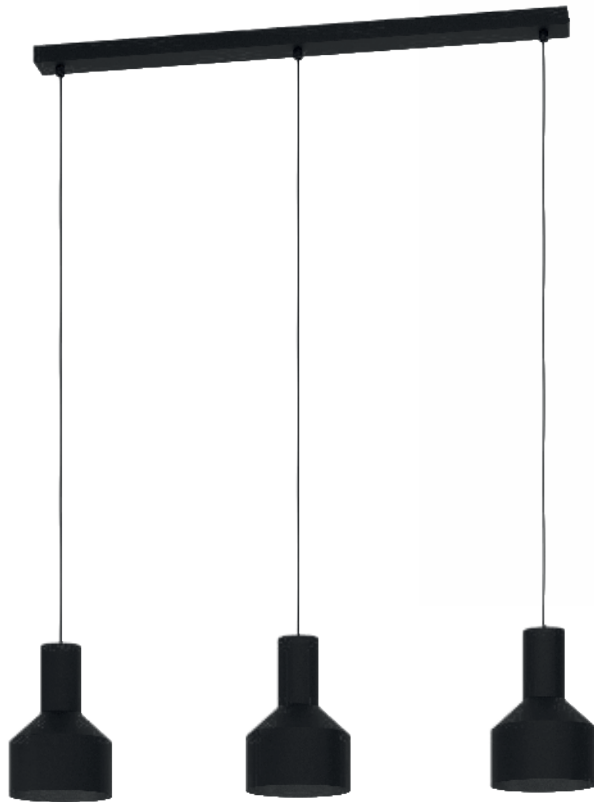

99552



99553

99551 CASIBARE

pendant light; steel, black
Hängeleuchte; Stahl, schwarz
luminaire en suspension; acier, noir

H 1100, Ø 150



9 002759 995515



99552 CASIBARE

pendant light; steel, black
Hängeleuchte; Stahl, schwarz
luminaire en suspension; acier, noir

L 850, B 150, H 1100



9 002759 995522

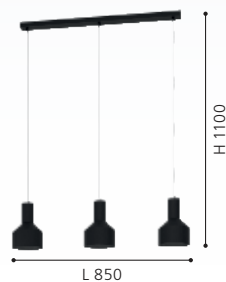

99553 CASIBARE

pendant light; steel, black
Hängeleuchte; Stahl, schwarz
luminaire en suspension; acier, noir

H 1500, Ø 710



9 002759 995539





99554



99555

99554 CASIBARE

table light; steel, black
Tischleuchte; Stahl, schwarz
luminaire de table; acier, noir

L 160, B 120, H 490, Base: Ø 155

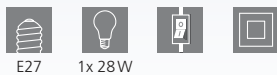

E27 1x 28W



9 002759 995546



99555 CASIBARE

floor light; steel, black
Stehleuchte; Stahl, schwarz
lampadaire; acier, noir

L 350, B 120, H 1605, Base: Ø 250

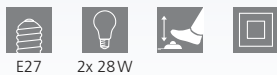

E27 2x 28W



9 002759 995553





99345



900164



99346

99345 CREMELLA

pendant light; steel, black
Hängeleuchte; Stahl, schwarz
luminaire en suspension; acier, noir

H 1100, Ø 370



900164 CREMELLA

ceiling light; steel, black
Deckenleuchte; Stahl, schwarz
plafonnier; acier, noir

H 260, Ø 370

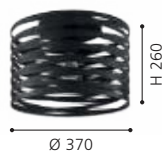
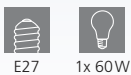

99346 CREMELLA

pendant light; steel, black
Hängeleuchte; Stahl, schwarz
luminaire en suspension; acier, noir

H 1100, Ø 180

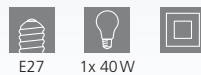



99347 CREMELLA

pendant light; steel, black
Hängeleuchte; Stahl, schwarz
luminaire en suspension; acier, noir

L 940, B 180, H 1100



E27 3x 40W



9 002759 993474

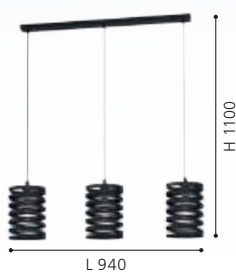

99506 CREMELLA

table light; steel, black
Tischleuchte; Stahl, schwarz
luminaire de table; acier, noir

H 290, Ø 180, Base: Ø 180



E27 1x 40W



9 002759 995065



99507 CREMELLA

floor light; steel, black
Stehleuchte; Stahl, schwarz
lampadaire; acier, noir

H 1510, Ø 370, Base: Ø 250



E27 1x 40W



9 002759 995072

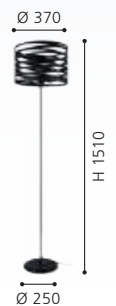



900494



900495

900494 ROMAZZINA

pendant light; steel, black
Hängeleuchte; Stahl, schwarz
luminaire en suspension; acier, noir

H 1100, Ø 325



E27



1x 40W



9 008606 244287



900495 ROMAZZINA

pendant light; steel, black
Hängeleuchte; Stahl, schwarz
luminaire en suspension; acier, noir

L 900, B 200, H 1100



E27



3x 40W



9 008606 244294



900519 ROMAZZINA

table light; steel, black
Tischleuchte; Stahl, schwarz
luminaire de table; acier, noir

H 435, Ø 200, Base: Ø 225



E27



1x 40W



9 008606 244485





900519

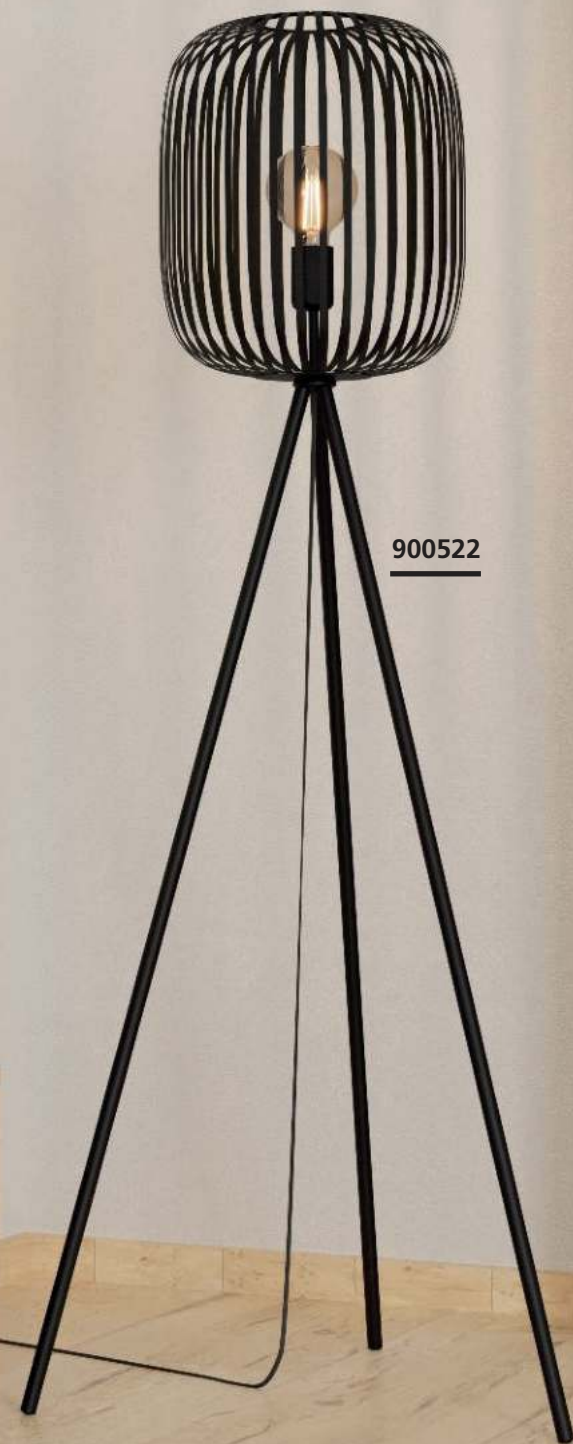

900522

900522 ROMAZZINA

floor light; steel, black
 Stehleuchte; Stahl, schwarz
 lampadaire; acier, noir

H 1405, Ø 325, Base: Ø 630



E27



1x 40W



9 008606 244508

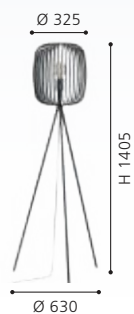



900496



DESIGN
HIGHLIGHT
DETAIL

900496 ROMAZZINA

pendant light; steel, sandy
Hängeleuchte; Stahl, sandfarben
luminaire en suspension; acier, couleur sable

H 1100, Ø 325



E27



1x 40W



9 008606 244300





900497 ROMAZZINA

pendant light; steel, sandy
Hängeleuchte; Stahl, sandfarben
luminaire en suspension; acier, couleur sable

L 900, B 200, H 1100



900521 ROMAZZINA

table light; steel, sandy
Tischleuchte; Stahl, sandfarben
luminaire de table; acier, couleur sable

H 435, Ø 200, Base: Ø 225



900523 ROMAZZINA

floor light; steel, sandy
Stehleuchte; Stahl, sandfarben
lampadaire; acier, couleur sable

H 1405, Ø 325, Base: Ø 630





900165

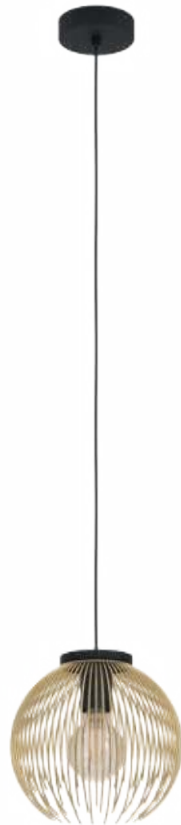

900166



900167

900165 VENEZUELA

ceiling light; steel, black, gold
Deckenleuchte; Stahl, schwarz, gold
plafonnier; acier, noir, or

H 250, Ø 385



E27 1x 40W



9 008606 242771



900166 VENEZUELA

pendant light; steel, black, gold
Hängeleuchte; Stahl, schwarz, gold
luminaire en suspension; acier, noir, or

H 1100, Ø 235



E27 1x 40W



9 008606 242788



900167 VENEZUELA

pendant light; steel, black, gold
Hängeleuchte; Stahl, schwarz, gold
luminaire en suspension; acier, noir, or

L 935, B 235, H 1100



E27 3x 40W



9 008606 242795





900168

900168 VENEZUELA

table light; steel, black, gold
Tischleuchte; Stahl, schwarz, gold
luminaire de table; acier, noir, or

H 225, Ø 235, Base: Ø 115



E27



1x 40W

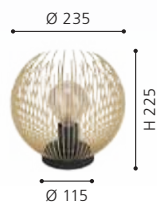



99806 ESCANDIDOS

pendant light; steel, black, brass / steel, black, gold
 Hängeleuchte; Stahl, schwarz, messing / Stahl, schwarz, gold
 luminaire en suspension; acier, noir, laiton / acier, noir, or

H 1100, Ø 220



99807 ESCANDIDOS

pendant light; steel, black, brass / steel, black, gold
 Hängeleuchte; Stahl, schwarz, messing / Stahl, schwarz, gold
 luminaire en suspension; acier, noir, laiton / acier, noir, or

L 920, B 220, H 1100



99809 ESCANDIDOS

floor light; steel, black, brass / steel, black, gold
 Stehleuchte; Stahl, schwarz, messing / Stahl, schwarz, gold
 lampadaire; acier, noir, laiton / acier, noir, or

L 310, B 220, H 1700, Base: B 300, T 200





99808

99808 ESCANDIDOS

table light; steel, black, brass / steel, black, gold
Tischleuchte; Stahl, schwarz, messing / Stahl, schwarz, gold
luminaire de table; acier, noir, laiton / acier, noir, or

H 260, Ø 220, Base: Ø 150



E27



1x 40W



9 002759 998080





900177



DESIGN
HIGHLIGHT
DETAIL

900177 LURONE

pendant light; steel, black, brass
Hängeleuchte; Stahl, schwarz, messing
luminaire en suspension; acier, noir, laiton

L 1000, B 50, H 1100



E27



4x 10W



9 008606 241132

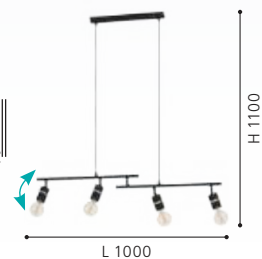



900176 LURONE

ceiling light; steel, black, brass
Deckenleuchte; Stahl, schwarz, messing
plafonnier; acier, noir, laiton

L 1000, B 50, H 270

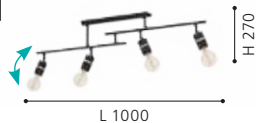

900178 LURONE

table light; steel, black, brass
Tischleuchte; Stahl, schwarz, messing
luminaire de table; acier, noir, laiton

L 205, B 50, H 500, Base: Ø 200



900179 LURONE

floor light; steel, black, brass
Stehleuchte; Stahl, schwarz, messing
lampadaire; acier, noir, laiton

L 205, B 50, H 1600, Base: Ø 250

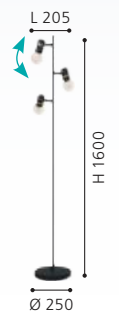
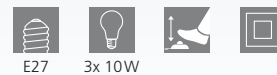



99592



DESIGN
HIGHLIGHT
DETAIL

99592 NARICES

pendant light; steel, black / steel, brushed brass, gold
Hängeleuchte; Stahl, schwarz / Stahl, messing-gebürstet, gold
luminaire en suspension; acier, noir / acier, laiton brossé, or

L 920, B 220, H 1100



E27



3x 40W

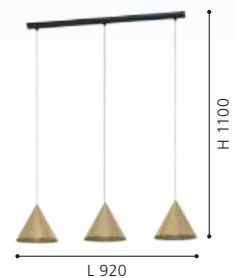

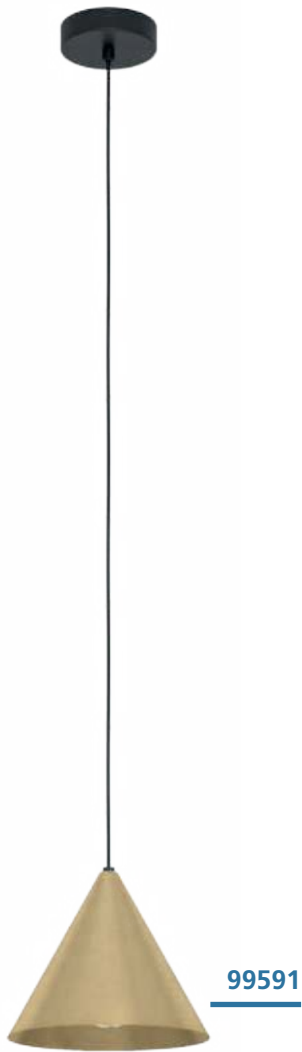

99591



99593



99594

99591 NARICES

pendant light; steel, black / steel, brushed brass, gold
 Hängeleuchte; Stahl, schwarz / Stahl, messing-gebürstet, gold
 luminaire en suspension; acier, noir / acier, laiton brossé, or

H 1100, Ø 220

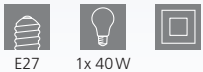

E27 1x 40W



9 002759 995911



99593 NARICES

table light; steel, black / steel, brushed brass, gold
 Tischleuchte; Stahl, schwarz / Stahl, messing-gebürstet, gold
 luminaire de table; acier, noir / acier, laiton brossé, or

L 295, B 220, H 500, Base: Ø 220



E27 1x 40W



9 002759 995935



99594 NARICES

floor light; steel, black / steel, brushed brass, gold
 Stehleuchte; Stahl, schwarz / Stahl, messing-gebürstet, gold
 lampadaire; acier, noir / acier, laiton brossé, or

L 295, B 220, H 1620, Base: Ø 270



E27 1x 40W



9 002759 995942





99098



99096



99097

99098 ERSEKA

pendant light; steel, brass / brilliant glass, clear
 Hängeleuchte; Stahl, messing / Brillantglas, klar
 luminaire en suspension; acier, laiton / verre brillant, transparent

H 1300, Ø 385

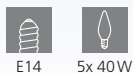

E14 5x 40W



99097 ERSEKA

pendant light; steel, brass / brilliant glass, clear
 Hängeleuchte; Stahl, messing / Brillantglas, klar
 luminaire en suspension; acier, laiton / verre brillant, transparent

H 1450, Ø 485



E14 7x 40W



99096 ERSEKA

ceiling light; steel, brass / brilliant glass, clear
 Deckenleuchte; Stahl, messing / Brillantglas, klar
 plafonnier; acier, laiton / verre brillant, transparent

H 535, Ø 485



E14 7x 40W





99095



99093



99094



EGLO
RECOMMENDS
110025

ERSEKA

99095 ERSEKA

pendant light; steel, chrome / brilliant glass, clear
Hängeleuchte; Stahl, chrom / Brillantglas, klar
luminaire en suspension; acier, chrome / verre brillant, transparent

H 1300, Ø 385



E14 5x 40W



9 002759 990954



H 1300

Ø 385

99094 ERSEKA

pendant light; steel, chrome / brilliant glass, clear
Hängeleuchte; Stahl, chrom / Brillantglas, klar
luminaire en suspension; acier, chrome / verre brillant, transparent

H 1450, Ø 485



E14 7x 40W



9 002759 990947



H 1450

Ø 485

99093 ERSEKA

ceiling light; steel, chrome / brilliant glass, clear
Deckenleuchte; Stahl, chrom / Brillantglas, klar
plafonnier; acier, chrome / verre brillant, transparent

H 535, Ø 485



E14 7x 40W



9 002759 990930



H 535

Ø 485



900305



MANZANARES

900305 MANZANARES

pendant light; steel, brushed brass, gold / glass opal-matt, white
Hängeleuchte; Stahl, messing-gebürstet, gold / Glas opal-matt, weiss

luminaire en suspension; acier, laiton brossé, or / verre opale mat, blanc

H 1100, Ø 225



E27



1x 40W



9 008606 235902

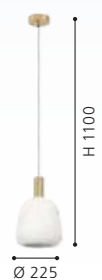



900306



900304



900307

900306 MANZANARES

pendant light; steel, brushed brass, gold / glass opal-matt, white
Hängeleuchte; Stahl, messing-gebürstet, gold / Glas opal-matt, weiss

luminaire en suspension; acier, laiton brossé, or / verre opale mat, blanc

L 970, B 145, H 1100

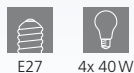

E27 4x 40W



9 008606 235919

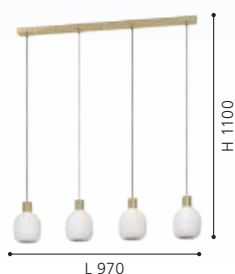

L 970

H 1100

900304 MANZANARES

ceiling light; steel, brushed brass, gold / glass opal-matt, white
Deckenleuchte; Stahl, messing-gebürstet, gold / Glas opal-matt, weiss

plafonnier; acier, laiton brossé, or / verre opale mat, blanc

H 190, Ø 450



E27 3x 40W



9 008606 235896

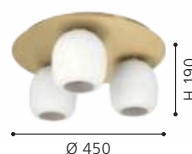

Ø 450

H 190

900307 MANZANARES

table light; steel, brushed brass, gold / glass opal-matt, white
Tischleuchte; Stahl, messing-gebürstet, gold / Glas opal-matt, weiss

luminaire de table; acier, laiton brossé, or / verre opale mat, blanc

H 180, Ø 145, Base: Ø 90

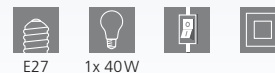

E27 1x 40W



9 008606 235926



Ø 90

H 180



85261



85262

85261 RONDO

pendant light; steel, satin nickel / glass opal-matt, white
 Hängeleuchte; Stahl, nickel-matt / Glas opal-matt, weiss
 luminaire en suspension; acier, nickel mat / verre opale mat, blanc

H 1100, Ø 200



85262 RONDO

pendant light; steel, satin nickel / glass opal-matt, white
 Hängeleuchte; Stahl, nickel-matt / Glas opal-matt, weiss
 luminaire en suspension; acier, nickel mat / verre opale mat, blanc

H 1100, Ø 250

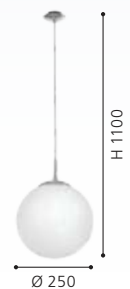



85263



91589



85264



RONDO

85263 RONDO

pendant light; steel, satin nickel / glass opal-matt, white
Hängeleuchte; Stahl, nickel-matt / Glas opal-matt, weiss
luminaire en suspension; acier, nickel mat / verre opale mat, blanc

H 1100, Ø 300



E27 1x 60W



91589 RONDO

ceiling light; steel, satin nickel / glass opal-matt, white
Deckenleuchte; Stahl, nickel-matt / Glas opal-matt, weiss
plafonnier; acier, nickel mat / verre opale mat, blanc

H 315, Ø 250



E27 1x 60W



85264 RONDO

table light; plastic, white / glass opal-matt, white
Tischleuchte; Kunststoff, weiss / Glas opal-matt, weiss
luminaire de table; plastique, blanc / verre opale mat, blanc

H 200, Ø 200

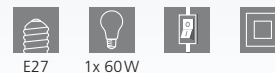

E27 1x 60W





900395

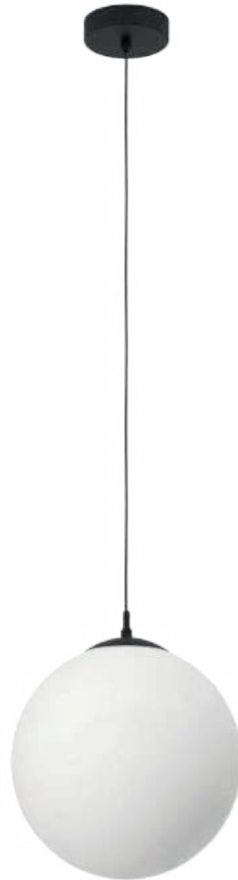

900511

900512

The flower pots are included with this luminaire.

Die Blumentöpfe sind bei dieser Leuchte inkludiert.

Les pots de fleurs sont inclus avec ce luminaire.



900395 RONDO

pendant light; steel, satin nickel / glass opal-matt, white
 Hängeleuchte; Stahl, nickel-matt / Glas opal-matt, weiss
 luminaire en suspension; acier, nickel mat / verre opale mat, blanc

L 960, B 200, H 1100



E27

3x 40W

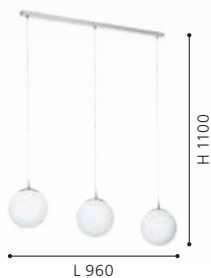

9 008606 239467

900511 RONDO 3

pendant light; steel, black / glass opal-matt, white
 Hängeleuchte; Stahl, schwarz / Glas opal-matt, weiss
 luminaire en suspension; acier, noir / verre opale mat, blanc

H 1100, Ø 300



E27

1x 40W



9 008606 244409

900512 RONDO 3

pendant light; steel, black / glass opal-matt, white
 Hängeleuchte; Stahl, schwarz / Glas opal-matt, weiss
 luminaire en suspension; acier, noir / verre opale mat, blanc

L 1210, B 200, H 1100



E27

3x 40W

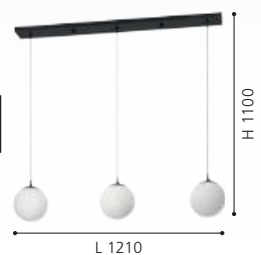

9 008606 244416



900512



86812



86811



OPTICA



86816

86811 OPTICA

wall / ceiling light; steel, satin nickel / glass opal-matt, white
Wand- / Deckenleuchte; Stahl, nickel-matt / Glas opal-matt, weiss
applique / plafonnier; acier, nickel mat / verre opale mat, blanc

H 160, Ø 280

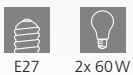

86812 OPTICA

wall / ceiling light; steel, satin nickel / glass opal-matt, white
Wand- / Deckenleuchte; Stahl, nickel-matt / Glas opal-matt, weiss
applique / plafonnier; acier, nickel mat / verre opale mat, blanc

H 210, Ø 350



86816 OPTICA

table light; steel, satin nickel / glass opal-matt, white
Tischleuchte; Stahl, nickel-matt / Glas opal-matt, weiss
luminaire de table; acier, nickel mat / verre opale mat, blanc

H 460, Ø 280, Base: Ø 195

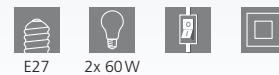

9 002759 868116



9 002759 868123

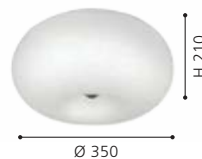

9 002759 868161



86817 OPTICA

floor light; steel, satin nickel / glass opal-matt, white
Stehleuchte; Stahl, nickel-matt / Glas opal-matt, weiss
lampadaire; acier, nickel mat / verre opale mat, blanc

H 1570, Ø 350



E27



2x 60W



9 002759 868178

Ø 350

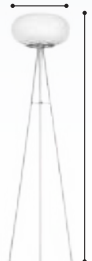

H 1570



86817

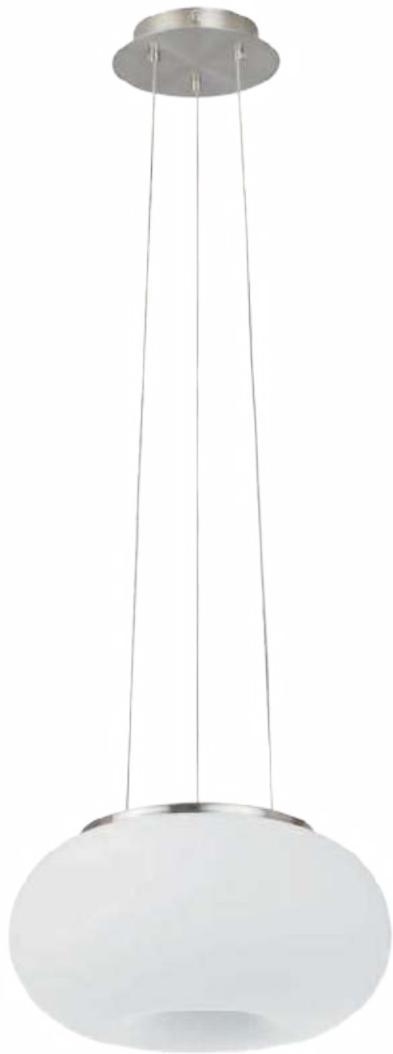

86813



86814



86813 OPTICA

pendant light; steel, satin nickel / glass opal-matt, white
 Hängeleuchte; Stahl, nickel-matt / Glas opal-matt, weiss
 luminaire en suspension; acier, nickel mat / verre opale mat, blanc

H 1100, Ø 280

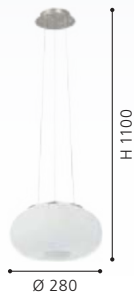

86814 OPTICA

pendant light; steel, satin nickel / glass opal-matt, white
 Hängeleuchte; Stahl, nickel-matt / Glas opal-matt, weiss
 luminaire en suspension; acier, nickel mat / verre opale mat, blanc

H 1100, Ø 350



86815 OPTICA

pendant light; steel, satin nickel / glass opal-matt, white
 Hängeleuchte; Stahl, nickel-matt / Glas opal-matt, weiss
 luminaire en suspension; acier, nickel mat / verre opale mat, blanc

H 1100, Ø 445

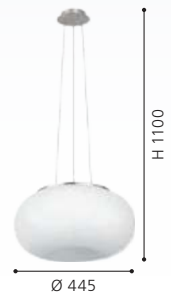



86815



99631



99632



DESIGN
HIGHLIGHT
DETAIL



33984

99631 GOROSIBA 1

ceiling light; steel, black / glass vaporized, black-transparent
Deckenleuchte; Stahl, schwarz / Glas bedampft, schwarz-transparent
plafonnier; acier, noir / verre vaporisé, noir transparent

H 175, Ø 450



E27 3x 40W

99632 GOROSIBA 1

ceiling light; steel, black / glass vaporized, black-transparent
Deckenleuchte; Stahl, schwarz / Glas bedampft, schwarz-transparent
plafonnier; acier, noir / verre vaporisé, noir transparent

L 380, B 380, H 170



E27 4x 40W

33984 GOROSIBA

table light; steel, black / glass vaporized, black-transparent
Tischleuchte; Stahl, schwarz / Glas bedampft, schwarz-transparent
luminaire de table; acier, noir / verre vaporisé, noir transparent

H 220, Ø 150, Base: Ø 100

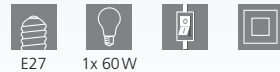

E27 1x 60W



9 002759 996314



9 002759 996321



9 002759 339845





98752



98752

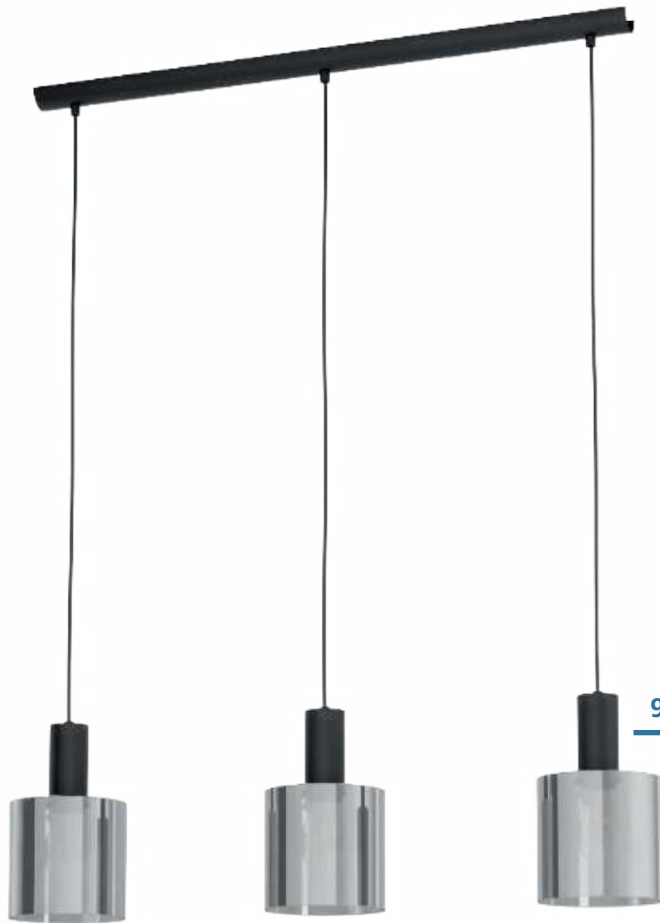

98753



98753 | 98754



98754

98752 GOROSIBA

pendant light; steel, black / glass vaporized, black-transparent
 Hängeleuchte; Stahl, schwarz / Glas bedampft, schwarz-transparent
 luminaire en suspension; acier, noir / verre vaporisé, noir transparent

H 1100, Ø 150



E27 1x 40W



9 002759 987527



98753 GOROSIBA

pendant light; steel, black / glass vaporized, black-transparent
 Hängeleuchte; Stahl, schwarz / Glas bedampft, schwarz-transparent
 luminaire en suspension; acier, noir / verre vaporisé, noir transparent

L 850, B 150, H 1100



E27 3x 40W



9 002759 987534



98754 GOROSIBA

pendant light; steel, black / glass vaporized, black-transparent
 Hängeleuchte; Stahl, schwarz / Glas bedampft, schwarz-transparent
 luminaire en suspension; acier, noir / verre vaporisé, noir transparent

H 1300, Ø 410



E27 3x 40W



9 002759 987541

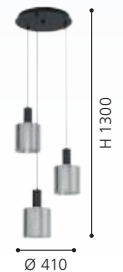

DESIGN
HIGHLIGHT
DETAIL



900341

900341 PINTO TEXTIL 1

pendant light; steel, black / glass, fabric, clear, black
Hängeleuchte; Stahl, schwarz / Glas, Textil, klar, schwarz
luminaire en suspension; acier, noir / verre, tissu, transparent, noir

H 1100, Ø 120



900342 PINTO TEXTIL 1

pendant light; steel, black / glass, fabric, clear, black
Hängeleuchte; Stahl, schwarz / Glas, Textil, klar, schwarz
luminaire en suspension; acier, noir / verre, tissu, transparent, noir

L 820, B 120, H 1100

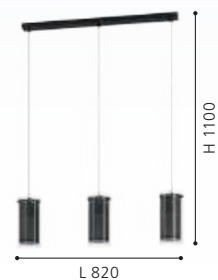



900342



99288



99288



99286

99288 PINTO TEXTIL

wall light; steel, satin nickel / glass, fabric, clear, grey
 Wandleuchte; Stahl, nickel-matt / Glas, Textil, klar, grau
 applique; acier, nickel mat / verre, tissu, transparent, gris

L 120, H 445, A 180



E27 1x 16W



9 002759 992880



99286 PINTO TEXTIL

pendant light; steel, satin nickel / glass, fabric, clear, grey
 Hängeleuchte; Stahl, nickel-matt / Glas, Textil, klar, grau
 luminaire en suspension; acier, nickel mat / verre, tissu, transparent, gris

L 820, B 120, H 1100



E27 3x 16W



9 002759 992866





99286 | 99287



99287



99287 PINTO TEXTIL

pendant light; steel, satin nickel / glass, fabric, clear, grey
 Hängeleuchte; Stahl, nickel-matt / Glas, Textil, klar, grau
 luminaire en suspension; acier, nickel mat / verre, tissu, transparent, gris

L 945, B 120, H 1100

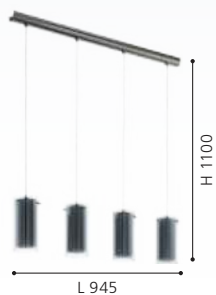



90304



PINTO NERO

90304 PINTO NERO

pendant light; steel, satin nickel / smoked glass, glass opal-matt, black-transparent, white

Hängeleuchte; Stahl, nickel-matt / Rauchglas, Glas opal-matt, schwarz-transparent, weiss

luminaire en suspension; acier, nickel mat / verre fumé, verre opale mat, noir transparent, blanc

H 1100, Ø 110



E27



1x 40W



9 002759 903046

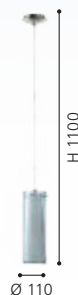

90305 PINTO NERO

pendant light; steel, satin nickel / smoked glass, glass opal-matt, black-transparent, white

Hängeleuchte; Stahl, nickel-matt / Rauchglas, Glas opal-matt, schwarz-transparent, weiss

luminaire en suspension; acier, nickel mat / verre fumé, verre opale mat, noir transparent, blanc

L 725, H 1100



E27



3x 40W



9 002759 903053

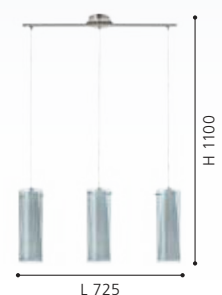



90305



97653



97839

97651

97653 PINTO GOLD

pendant light; steel, black / glass, clear, gold
 Hängeleuchte; Stahl, schwarz / Glas, klar, gold
 luminaire en suspension; acier, noir / verre, transparent, or

L 905, B 360, H 1100

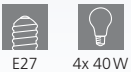

E27 4x 40W

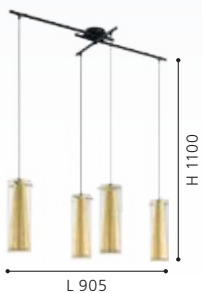

9 002759 976538

97651 PINTO GOLD

pendant light; steel, black / glass, clear, gold
 Hängeleuchte; Stahl, schwarz / Glas, klar, gold
 luminaire en suspension; acier, noir / verre, transparent, or

H 1100, Ø 110



E27 1x 40W



9 002759 976514

97839 PINTO GOLD

wall light; steel, black / glass, clear, gold
 Wandleuchte; Stahl, schwarz / Glas, klar, gold
 applique; acier, noir / verre, transparent, or

L 110, H 270, A 150



E27 1x 40W



9 002759 978396



97652



97655



PINTO GOLD



DESIGN
HIGHLIGHT
DETAIL



97652 PINTO GOLD

pendant light; steel, black / glass, clear, gold
Hängeleuchte; Stahl, schwarz / Glas, klar, gold
luminaire en suspension; acier, noir / verre, transparent, or

L 725, B 110, H 1100



9 002759 976521

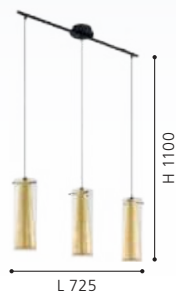

97655 PINTO GOLD

floor light; steel, black, gold / glass, clear, gold
Stehleuchte; Stahl, schwarz, gold / Glas, klar, gold
lampadaire; acier, noir, or / verre, transparent, or

H 1470, Ø 110, Base: Ø 230

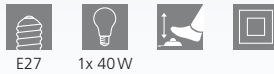

9 002759 976552

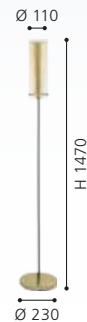

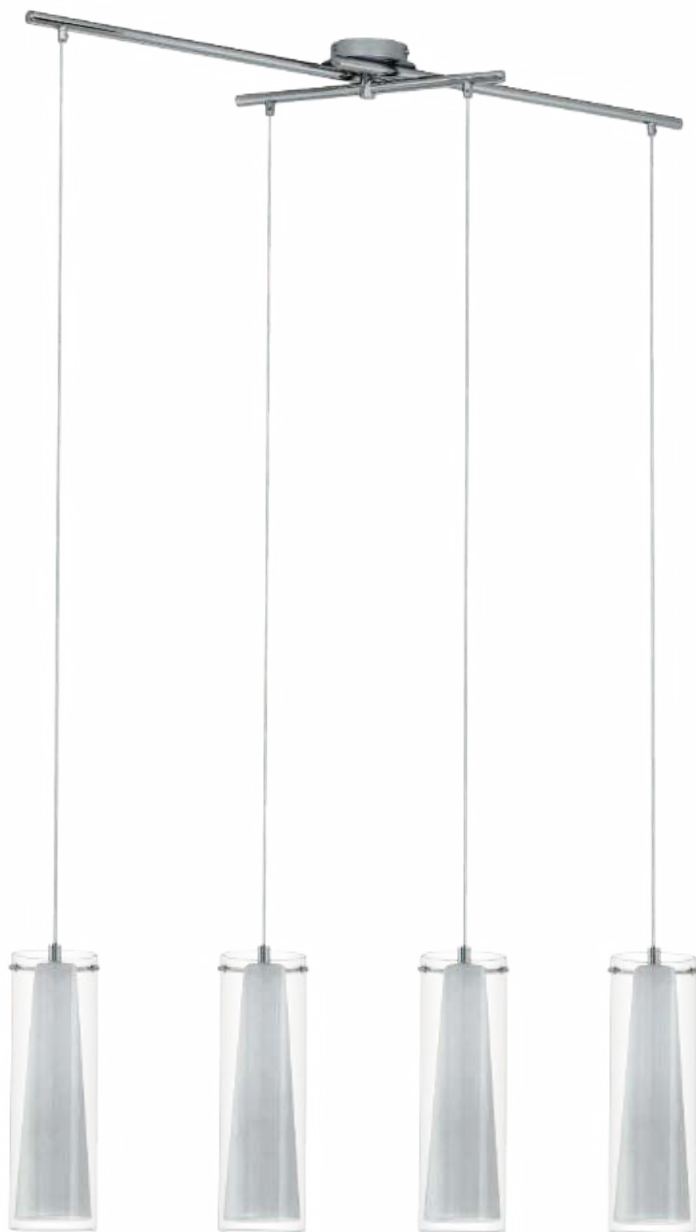

89834



89832 | 89833 | 89834 |
89835 | 89836



89832



89835

89834 PINTO

pendant light; steel, chrome / glass, glass opal-matt, clear, white
Hängeleuchte; Stahl, chrom / Glas, Glas opal-matt, klar, weiss
luminaire en suspension; acier, chrome / verre, verre opale mat, transparent, blanc

L 905, B 360, H 1100



E27



4x 40W

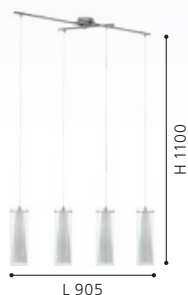

9 002759 898342

89835 PINTO

table light; steel, chrome / glass, glass opal-matt, clear, white
Tischleuchte; Stahl, chrom / Glas, Glas opal-matt, klar, weiss
luminaire de table; acier, chrome / verre, verre opale mat, transparent, blanc

H 500, Ø 110, Base: Ø 155



E27



1x 40W



9 002759 898359

89832 PINTO

pendant light; steel, chrome / glass, glass opal-matt, clear, white
Hängeleuchte; Stahl, chrom / Glas, Glas opal-matt, klar, weiss
luminaire en suspension; acier, chrome / verre, verre opale mat, transparent, blanc

H 1100, Ø 110



E27



1x 40W



9 002759 898328



93003



89833



89836

93003 PINTO

pendant light; steel, chrome / glass, glass opal-matt, clear, white
Hängeleuchte; Stahl, chrom / Glas, Glas opal-matt, klar, weiss
luminaire en suspension; acier, chrome / verre, verre opale mat, transparent, blanc

H 1500, Ø 500



E27 5x 40W



9 002759 930035



89833 PINTO

pendant light; steel, chrome / glass, glass opal-matt, clear, white
Hängeleuchte; Stahl, chrom / Glas, Glas opal-matt, klar, weiss
luminaire en suspension; acier, chrome / verre, verre opale mat, transparent, blanc

L 725, H 1100



E27 3x 40W



9 002759 898335



89836 PINTO

floor light; steel, chrome / glass, glass opal-matt, clear, white
Stehleuchte; Stahl, chrom / Glas, Glas opal-matt, klar, weiss
lampadaire; acier, chrome / verre, verre opale mat, transparent, blanc

H 1470, Ø 110, Base: Ø 230

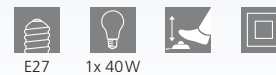

E27 1x 40W



9 002759 898366

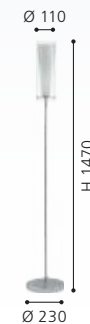



85978



85977

85978 TROY 3

pendant light; steel, satin nickel / satin glass, white painted
Hängeleuchte; Stahl, nickel-matt / Glas satiniert, weiss lackiert
luminaire en suspension; acier, nickel mat / verre satiné, blanc laqué

L 720, B 105, H 1100



E27



3x 40W



9 002759 859787



85977 TROY 3

pendant light; steel, satin nickel / satin glass, white painted
Hängeleuchte; Stahl, nickel-matt / Glas satiniert, weiss lackiert
luminaire en suspension; acier, nickel mat / verre satiné, blanc laqué

H 1100, Ø 110



E27



1x 40W



9 002759 859770



85979 TROY 3

wall light; steel, satin nickel / satin glass, white
Wandleuchte; Stahl, nickel-matt / Glas satiniert, weiss
applique; acier, nickel mat / verre satiné, blanc laqué

L 180, H 250, A 75



E14



1x 60W



9 002759 859794





85979



85979



85981



85977 | 85978 | 85981 |
85982

85981 TROY 3

table light; steel, satin nickel / satin glass, white painted
Tischleuchte; Stahl, nickel-matt / Glas satiniert, weiss lackiert
luminaire de table; acier, nickel mat / verre satiné, blanc laqué

H 460, Ø 105, Base: Ø 120



E27 1x 40W



9 002759 859817



85982 TROY 3

floor light; steel, satin nickel / satin glass, white painted
Stehleuchte; Stahl, nickel-matt / Glas satiniert, weiss lackiert
lampadaire; acier, nickel mat / verre satiné, blanc laqué

H 1530, Ø 105, Base: Ø 200

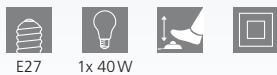

E27 1x 40W



9 002759 859824



85982



92739



92739 | 92741 | 92743

92739 RIVATO

pendant light; steel, chrome / glass with decor, white, chrome
Hängeleuchte; Stahl, chrom / Glas mit Dekor, weiss, chrom
luminaire en suspension; acier, chrome / verre avec décor, blanc, chrome

H 1100, Ø 90



E27



1x 60W





92741



92742



92743



92742

92741 RIVATO

pendant light; steel, chrome / glass with decor, white, chrome
Hängeleuchte; Stahl, chrom / Glas mit Dekor, weiss, chrom
luminaire en suspension; acier, chrome / verre avec décor, blanc, chrome

L 705, B 90, H 1100

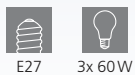

E27 3x 60W



9 002759 927417

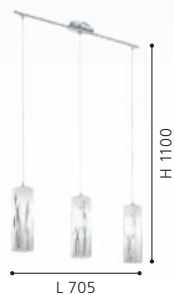

L 705

H 1100

92742 RIVATO

wall light; steel, white, chrome / glass with decor, white, chrome
Wandleuchte; Stahl, weiss, chrom / Glas mit Dekor, weiss, chrom
applique; acier, blanc, chrome / verre avec décor, blanc, chrome

L 180, H 250, A 80



E14 1x 42W



9 002759 927424



L 180

H 250

92743 RIVATO

table light; glass, plastic, white, chrome
Tischleuchte; Glas, Kunststoff, weiss, chrom
luminaire de table; verre, plastique, blanc, chrome

H 260, Ø 90

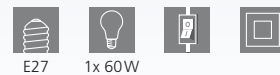

E27 1x 60W



9 002759 927431



Ø 90

H 260



90048



90049



EGLO
RECOMMENDS
110043

90049

90048 AMADORA

pendant light; steel, satin nickel / glass printed, white
Hängeleuchte; Stahl, nickel-matt / Glas bedruckt, weiss
luminaire en suspension; acier, nickel mat / verre imprimé, blanc

L 720, B 105, H 1100



E27



3x 60W



9 002759 900489



L 720

H 1100

90049 AMADORA

wall light; steel, satin nickel / glass printed, white
Wandleuchte; Stahl, nickel-matt / Glas bedruckt, weiss
applique; acier, nickel mat / verre imprimé, blanc

L 180, H 250, A 75



E14



1x 60W



9 002759 900496



L 180

H 250



92563



90048 | 91971 | 92563



91971

92563 BAYMAN

pendant light; steel, chrome / glass, white, chrome
 Hängeleuchte; Stahl, chrom / Glas, weiss, chrom
 luminaire en suspension; acier, chrome / verre, blanc, chrome

L 720, B 105, H 1100

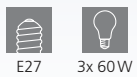

91971 BAYMAN

table light; glass, plastic, white, chrome
 Tischleuchte; Glas, Kunststoff, weiss, chrom
 luminaire de table; verre, plastique, blanc, chrome

H 270, Ø 105

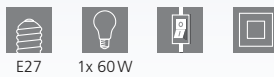



91433



91002



91004

91433 VINOVO

pendant light; steel, dark brown / glass alabaster, white
 Hängeleuchte; Stahl, dunkelbraun / Glas alabaster, weiss
 luminaire en suspension; acier, marron foncé / verre albâtre, blanc

L 770, B 250, H 1100



E27



2x 60W



9 002759 914332



91002 MURCIA

pendant light; steel, black / glass alabaster, white
 Hängeleuchte; Stahl, schwarz / Glas alabaster, weiss
 luminaire en suspension; acier, noir / verre albâtre, blanc

H 1100, Ø 380



E27



1x 60W



9 002759 910020



91004 MURCIA

pendant light; steel, black / glass alabaster, white
 Hängeleuchte; Stahl, schwarz / Glas alabaster, weiss
 luminaire en suspension; acier, noir / verre albâtre, blanc

L 680, H 1100



E27



2x 60W



9 002759 910044

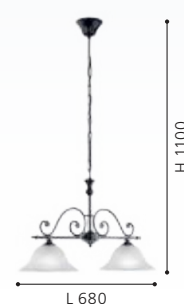



MURCIA, VINOVO

These luminaires come with high quality processed alabaster glass.

Diese Leuchten sind mit hochwertigem Alabasterglas ausgestattet.

Ces luminaires viennent avec un abat-jour en verre d'albâtre haut de gamme.

91005 MURCIA

pendant light; steel, black / glass alabaster, white
Hängeleuchte; Stahl, schwarz / Glas alabaster, weiss
luminaire en suspension; acier, noir / verre albâtre, blanc

H 1100, Ø 630

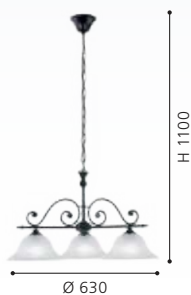
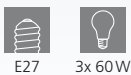

91006 MURCIA

wall light; steel, black / glass alabaster, white
Wandleuchte; Stahl, schwarz / Glas alabaster, weiss
applique; acier, noir / verre albâtre, blanc

L 165, H 190, A 230

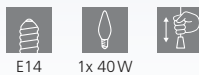



82748



82749



DESIGN
HIGHLIGHT
DETAIL

82748 SAVOY

pendant light; cast metal, bronzed / satin glass, white
Hängeleuchte; Metallguss, brüniert / Glas satiniert, weiss
luminaire en suspension; fonte métallique, brun / verre satiné, blanc

H 1100, Ø 740



82749 SAVOY

pendant light; cast metal, bronzed / satin glass, white
Hängeleuchte; Metallguss, brüniert / Glas satiniert, weiss
luminaire en suspension; fonte métallique, brun / verre satiné, blanc

H 1100, Ø 740





82751 SAVOY

wall light; cast metal, bronzed / satin glass, white
Wandleuchte; Metallguss, brüniert / Glas satiniert, weiss
applique; fonte métallique, brun / verre satiné, blanc

L 180, H 160, A 240



82752 SAVOY

wall light; cast metal, bronzed / satin glass, white
Wandleuchte; Metallguss, brüniert / Glas satiniert, weiss
applique; fonte métallique, brun / verre satiné, blanc

L 410, H 160, A 210



82747 SAVOY

pendant light; cast metal, bronzed / satin glass, white
Hängeleuchte; Metallguss, brüniert / Glas satiniert, weiss
luminaire en suspension; fonte métallique, brun / verre satiné, blanc

H 1100, Ø 310

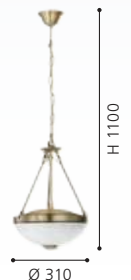



85856 MARBELLA

ceiling light; cast metal, bronzed / glass alabaster, champagne
Deckenleuchte; Metallguss, brüniert / Glas alabaster, champagner
plafonnier; fonte métallique, brun / verre albâtre, champagne

H 410, Ø 370



85857 MARBELLA

pendant light; cast metal, bronzed / glass alabaster, champagne
Hängeleuchte; Metallguss, brüniert / Glas alabaster, champagner
luminaire en suspension; fonte métallique, brun / verre albâtre, champagne

H 1100, Ø 740



85859 MARBELLA

wall light; cast metal, bronzed / glass alabaster, champagne
Wandleuchte; Metallguss, brüniert / Glas alabaster, champagner
applique; fonte métallique, brun / verre albâtre, champagne

L 170, H 200, A 230





85858

85858 MARBELLA

pendant light; cast metal, bronzed / glass alabaster, champagne
 Hängeleuchte; Metallguss, brüniert / Glas alabaster, champagner
 luminaire en suspension; fonte métallique, brun / verre albâtre, champagne

H 1100, Ø 740



MARBELLA

These luminaires come with high quality processed alabaster glass.

Diese Leuchten sind mit hochwertigem Alabasterglas ausgestattet.

Ces luminaires viennent avec un abat-jour en verre d'albâtre haut de gamme.



98876 ERVIDEL

pendant light; steel, black / plastic, satined, clear
 Hängeleuchte; Stahl, schwarz / Kunststoff, satiniert, klar
 luminaire en suspension; acier, noir / plastique, satiné, transparent

L 930, B 60, H 1100



6x 4,5W 2880lm



9 002759 988760

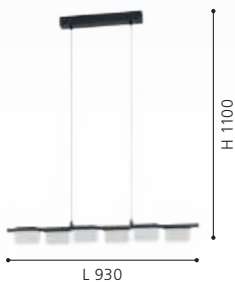

98874 ERVIDEL

ceiling light; steel, black / plastic, satined, clear
 Deckenleuchte; Stahl, schwarz / Kunststoff, satiniert, klar
 plafonnier; acier, noir / plastique, satiné, transparent

L 625, B 60, H 160



4x 4,5W 1920lm



9 002759 988746



98875 ERVIDEL

ceiling light; steel, black / plastic, satined, clear
 Deckenleuchte; Stahl, schwarz / Kunststoff, satiniert, klar
 plafonnier; acier, noir / plastique, satiné, transparent

L 930, B 60, H 160



6x 4,5W 2880lm



9 002759 988753





98878

LED



98877

LED

98878 ERVIDEL

table light; steel, black / plastic, satined, clear
Tischleuchte; Stahl, schwarz / Kunststoff, satiniert, klar
luminaire de table; acier, noir / plastique, satiné, transparent

L 155, B 60, H 500, Base: B 180, T 180



2x 4,5W 960lm



9 002759 988784



98877 ERVIDEL

wall light; steel, black / plastic, satined, clear
Wandleuchte; Stahl, schwarz / Kunststoff, satiniert, klar
applique; acier, noir / plastique, satiné, transparent

L 320, H 90, A 80

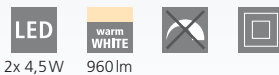

2x 4,5W 960lm



9 002759 988777





900351



900352



900351 CLAVELLINA

ceiling light; steel, black / plastic, white
 Deckenleuchte; Stahl, schwarz / Kunststoff, weiss
 plafonnier; acier, noir / plastique, blanc

L 890, B 465, H 185



4x 6,8W 3200lm



900352 CLAVELLINA

pendant light; steel, black / plastic, white
 Hängeleuchte; Stahl, schwarz / Kunststoff, weiss
 luminaire en suspension; acier, noir / plastique, blanc

L 1200, B 400, H 1100



6x 7W 4800lm

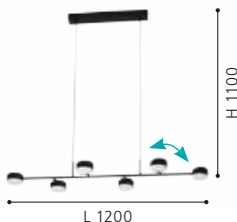

900353 CLAVELLINA

table light; steel, black / plastic, white
 Tischleuchte; Stahl, schwarz / Kunststoff, weiss
 luminaire de table; acier, noir / plastique, blanc

L 550, H 450, Base: Ø 180



1x 6,8W 800lm





900353



900354 CLAVELLINA

floor light; steel, black / plastic, white
 Stehleuchte; Stahl, schwarz / Kunststoff, weiss
 lampadaire; acier, noir / plastique, blanc

L 1215, H 1605, Base: Ø 300



24W



2210lm

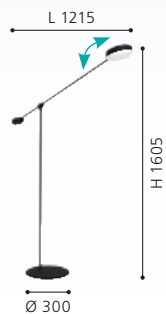

9 008606 243518



900354





99562



DESIGN
HIGHLIGHT
DETAIL

99562 ISIDRO

pendant light; aluminium, steel, black / plastic, satined
Hängeleuchte; Alu, Stahl, schwarz / Kunststoff, satiniert
luminaire en suspension; aluminium, acier, noir / plastique, satiné

L 795, B 60, H 1100



27W



3850lm



9 002759 995621

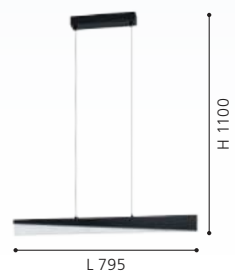



99561



99563



99564



99561 ISIDRO

ceiling light; aluminium, steel, black / plastic, satined
Deckenleuchte; Alu, Stahl, schwarz / Kunststoff, satiniert
plafonnier; aluminium, acier, noir / plastique, satiné

L 860, B 80, H 110



2x 11 W 2700lm



9 002759 995614



99563 ISIDRO

wall light; aluminium, steel, black / plastic, satined
Wandleuchte; Alu, Stahl, schwarz / Kunststoff, satiniert
applique; aluminium, acier, noir / plastique, satiné

L 395, H 80, A 70



9 W 1050lm



9 002759 995638



99564 ISIDRO

table light; aluminium, steel, black / plastic, satined
Tischleuchte; Alu, Stahl, schwarz / Kunststoff, satiniert
luminaire de table; aluminium, acier, noir / plastique, satiné

L 70, B 15, H 410, Base: B 150, T 130



9 W 1050lm



9 002759 995645

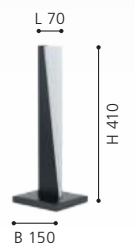



900563

LED



CARANACOA

These luminaires have swiveling light rings.

Diese Leuchten verfügen über schwenkbare Leuchtringe.

Ces luminaires ont des anneaux lumineux pivotants.

900563 CARANACOA

pendant light; steel, black / plastic, white
 Hängeleuchte; Stahl, schwarz / Kunststoff, weiss
 luminaire en suspension; acier, noir / plastique, blanc

L 1170, B 230, H 1100

LED

5x 7W

warm
 WHITE

7000lm



9 008606 244652

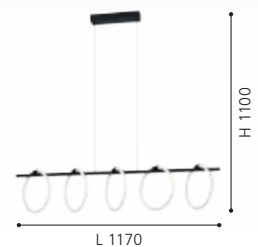



900562



900564



900565



900562 CARANACOA

pendant light; steel, black / plastic, white
 Hängeleuchte; Stahl, schwarz / Kunststoff, weiss
 luminaire en suspension; acier, noir / plastique, blanc

L 780, B 230, H 1100



3x 9W 3600lm



9 008606 244645

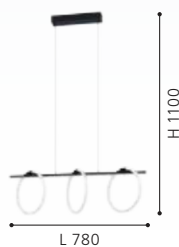

900564 CARANACOA

wall light; steel, black / plastic, white
 Wandleuchte; Stahl, schwarz / Kunststoff, weiss
 applique; acier, noir / plastique, blanc

L 260, H 260, A 45



11,5W 1500lm



9 008606 244669



900565 CARANACOA

table light; steel, black / plastic, white
 Tischleuchte; Stahl, schwarz / Kunststoff, weiss
 luminaire de table; acier, noir / plastique, blanc

L 260, B 50, H 260, Base: Ø 100



11,5W 1500lm



9 008606 244676





39836

LED



99429

LED

39836 BANDERILLAS

ceiling light; steel, black / plastic, white, black
Deckenleuchte; Stahl, schwarz / Kunststoff, weiss, schwarz
plafonnier; acier, noir / plastique, blanc, noir

L 1160, B 170, H 200



2x 12W
2x
1950lm



9 002759 398361



99429 ALAMEDILLA

pendant light; steel, black / plastic, white, black
Hängeleuchte; Stahl, schwarz / Kunststoff, weiss, schwarz
luminaire en suspension; acier, noir / plastique, blanc, noir

L 970, B 380, H 1200



27W
4200lm



9 002759 994297



39838 BANDERILLAS

table light; plastic, black / plastic, white
Tischleuchte; Kunststoff, schwarz / Kunststoff, weiss
luminaire de table; plastique, noir / plastique, blanc

H 300, Ø 195



10W
1300lm



9 002759 398385





39838

LED

39839 BANDERILLAS

pendant light; steel, black / plastic, white, black
 Hängeleuchte; Stahl, schwarz / Kunststoff, weiss, schwarz
 luminaire en suspension; acier, noir / plastique, blanc, noir

H 1200, Ø 600

LED

22W

warm
WHITE

3500lm

LED

14W

warm
WHITE

2300lm

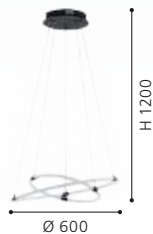

39839

LED



99358



900631



900632



99358 CODRIALES

pendant light; steel, black / plastic, white
Hängeleuchte; Stahl, schwarz / Kunststoff, weiss
luminaire en suspension; acier, noir / plastique, blanc

L 780, B 300, H 1100



27W



4000lm



9 002759 993580



900631 CODRIALES

ceiling light; aluminium, black / plastic, white
Deckenleuchte; Alu, schwarz / Kunststoff, weiss
plafonnier; aluminium, noir / plastique, blanc

L 790, B 300, H 116



27W



4000lm



9 008606 241040



900632 CODRIALES

wall light; aluminium, black / plastic, white
Wandleuchte; Alu, schwarz / Kunststoff, weiss
applique; aluminium, noir / plastique, blanc

L 180, H 320, A 65



10,8W



1400lm



9 008606 241057





900633



900633 CODRIALES

table light; aluminium, black / plastic, white

Tischleuchte; Alu, schwarz / Kunststoff, weiss

luminaire de table; aluminium, noir / plastique, blanc

L 205, B 80, H 380



10,8W



1500lm



9 008606 241064

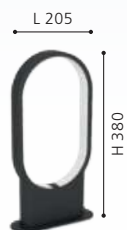



900465 SIBERIA

ceiling light; steel, black / plastic, white
 Deckenleuchte; Stahl, schwarz / Kunststoff, weiss
 plafonnier; acier, noir / plastique, blanc

L 780, B 160, H 235



34W 4600lm



9 008606 244041



900466 SIBERIA

pendant light; steel, black / plastic, white
 Hängeleuchte; Stahl, schwarz / Kunststoff, weiss
 luminaire en suspension; acier, noir / plastique, blanc

L 780, B 160, H 1100



34W 4500lm



9 008606 244058

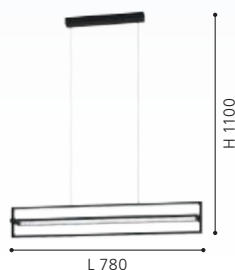

900467 SIBERIA

wall light; steel, black / plastic, white
 Wandleuchte; Stahl, schwarz / Kunststoff, weiss
 applique; acier, noir / plastique, blanc

L 160, H 300, A 190



15,5W 2200lm



9 008606 244065





900468

LED

incl./inkl./inclus



900469

LED

900468 SIBERIA

table light; steel, black / plastic, white
Tischleuchte; Stahl, schwarz / Kunststoff, weiss
luminaire de table; acier, noir / plastique, blanc

L 160, B 160, H 430, Base: B 160, T 160



15,5W 2200lm



9 008606 244072

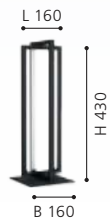

900469 SIBERIA

floor light; steel, black / plastic, white
Stehleuchte; Stahl, schwarz / Kunststoff, weiss
lampadaire; acier, noir / plastique, blanc

L 200, B 160, H 1330, Base: B 200, T 160



34W 4600lm



9 008606 244089

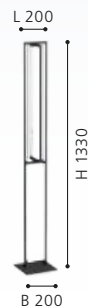



99799 LEJIAS

ceiling light; steel, black / plastic, transparent
Deckenleuchte; Stahl, schwarz / Kunststoff, transparent
plafonnier; acier, noir / plastique, transparent

L 450, B 450, H 75



99801 LEJIAS

ceiling light; steel, black / plastic, transparent
Deckenleuchte; Stahl, schwarz / Kunststoff, transparent
plafonnier; acier, noir / plastique, transparent

L 780, B 80



99802 LEJIAS

pendant light; steel, black / plastic, transparent
Hängeleuchte; Stahl, schwarz / Kunststoff, transparent
luminaire en suspension; acier, noir / plastique, transparent

L 780, B 80, H 1750

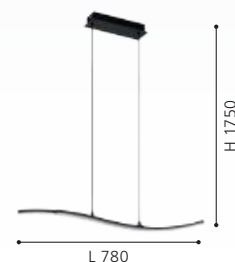



99803

LED

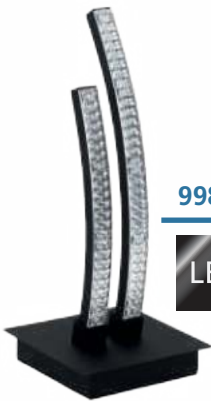

99804

LED



99805

LED

99803 LEJIAS

wall light; steel, black / plastic, transparent
Wandleuchte; Stahl, schwarz / Kunststoff, transparent
applique; acier, noir / plastique, transparent

L 90, H 285



8W 1050lm



9 002759 998035



99804 LEJIAS

table light; steel, black / plastic, transparent
Tischleuchte; Stahl, schwarz / Kunststoff, transparent
luminaire de table; acier, noir / plastique, transparent

H 330, Base: B 140, T 140



8W 900lm



9 002759 998042



99805 LEJIAS

floor light; steel, black / plastic, transparent
Stehleuchte; Stahl, schwarz / Kunststoff, transparent
lampadaire; acier, noir / plastique, transparent

H 1230, Base: B 230, T 230



16W 2050lm



9 002759 998059



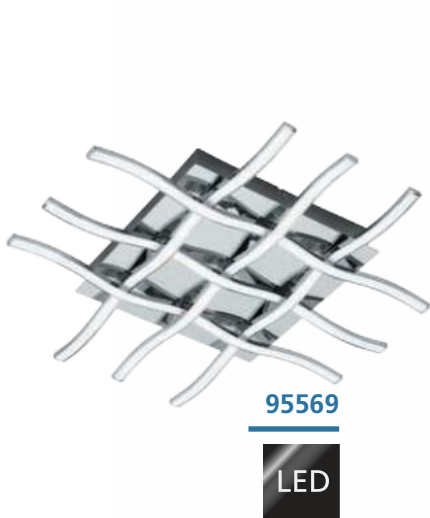

95569

LED

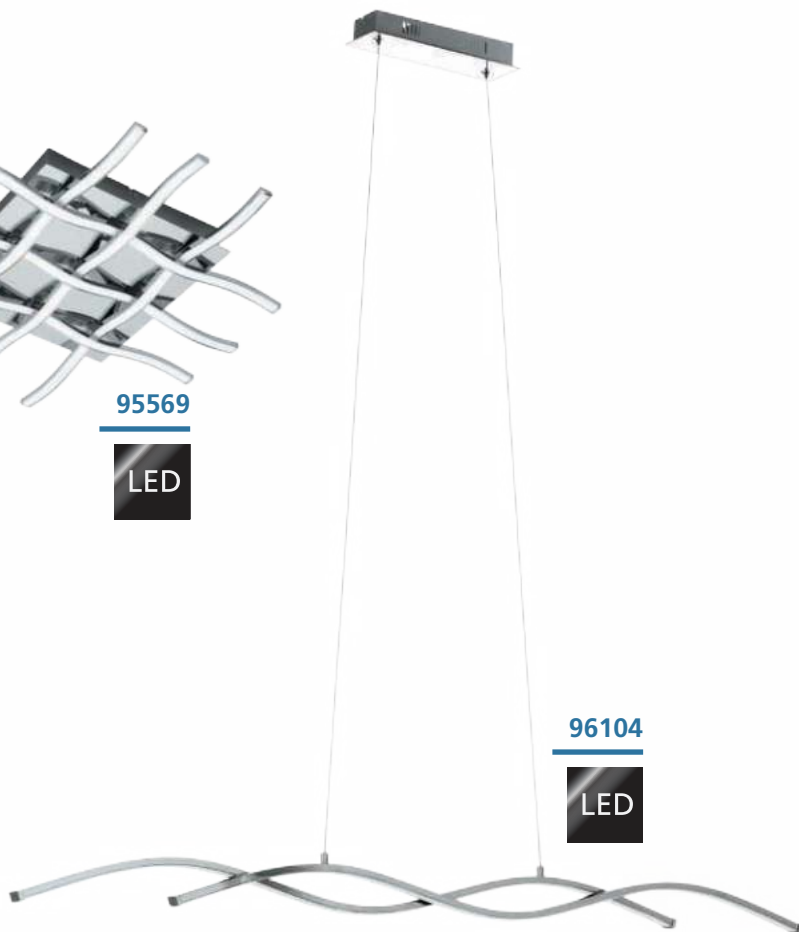

96104

LED

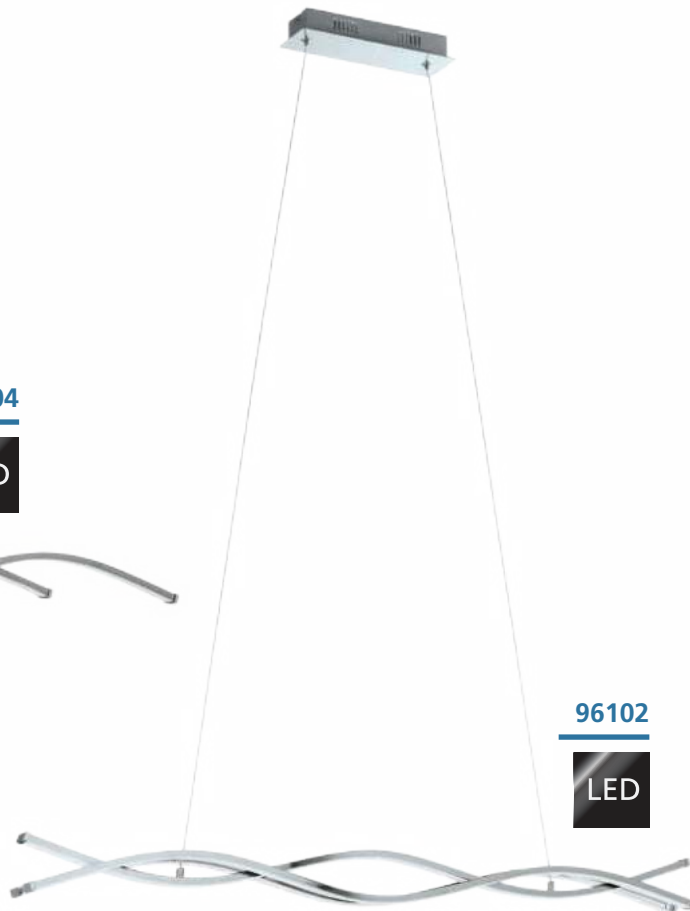

96102

LED

95569 LASANA 1

wall / ceiling light; steel, chrome / plastic, white
Wand- / Deckenleuchte; Stahl, chrom / Kunststoff, weiss
applique / plafonnier; acier, chrome / plastique, blanc

L 500, B 500, H 65

LED

warm
WHITE



6x 6W

4860lm



9 002759 955694

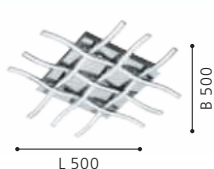

96104 LASANA 2

pendant light; steel, aluminium, chrome / plastic, white
Hängeleuchte; Stahl, Alu, chrom / Kunststoff, weiss
luminaire en suspension; acier, aluminium, chrome / plastique, blanc

L 1200, B 80, H 1200

LED

warm
WHITE



24,5W

3300lm



9 002759 961046



96102 LASANA 2

pendant light; steel, aluminium, chrome / plastic, white
Hängeleuchte; Stahl, Alu, chrom / Kunststoff, weiss
luminaire en suspension; acier, aluminium, chrome / plastique, blanc

L 1000, B 80, H 1200

LED

warm
WHITE



35W

5300lm



9 002759 961022

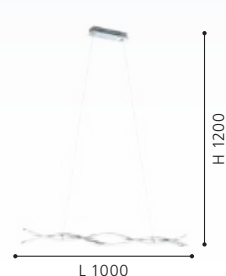

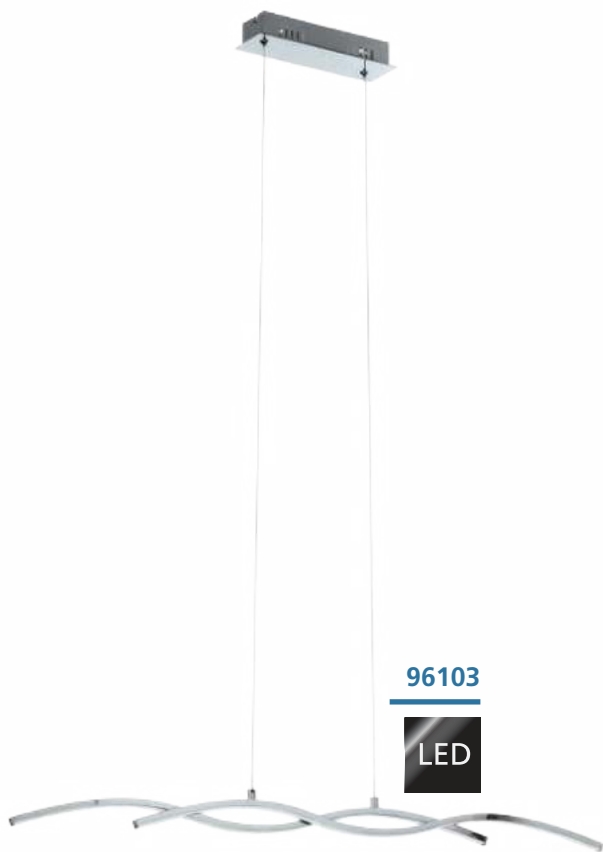

96103



96105



96106



96103 LASANA 2

pendant light; steel, aluminium, chrome / plastic, white
 Hängeleuchte; Stahl, Alu, chrom / Kunststoff, weiss
 luminaire en suspension; acier, aluminium, chrome / plastique, blanc

L 870, B 80, H 1200



18W 2300lm



9 002759 961039

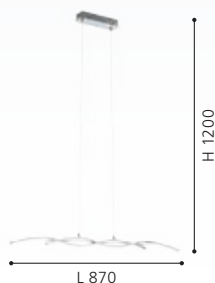

96105 LASANA 2

table light; steel, aluminium, chrome / plastic, white
 Tischleuchte; Stahl, Alu, chrom / Kunststoff, weiss
 luminaire de table; acier, aluminium, chrome / plastique, blanc

L 160, B 100, H 460



11,5W 1280lm



9 002759 961053



96106 LASANA 2

floor light; steel, aluminium, chrome / plastic, white
 Stehleuchte; Stahl, Alu, chrom / Kunststoff, weiss
 lampadaire; acier, aluminium, chrome / plastique, blanc

L 250, B 130, H 1420



36W 4700lm



9 002759 961060



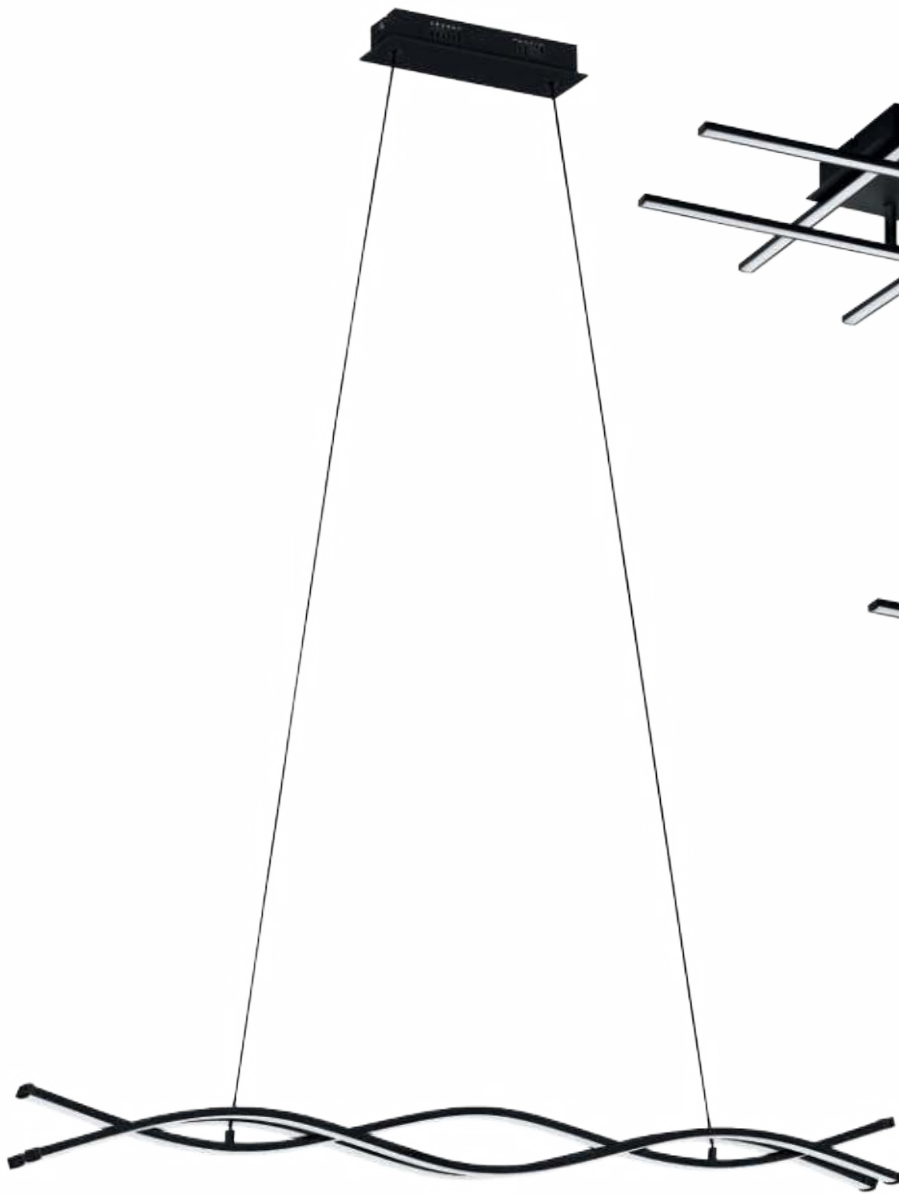

99317

LED

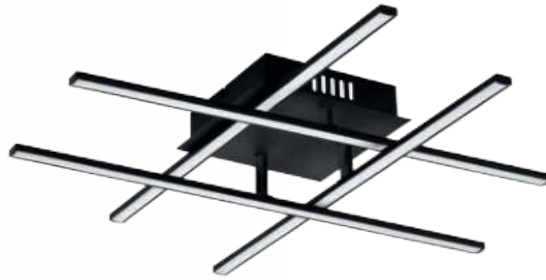

99316

LED



99315

LED

99317 LASANA 3

pendant light; steel, aluminium, black / plastic, white
Hängeleuchte; Stahl, Alu, schwarz / Kunststoff, weiss
luminaire en suspension; acier, aluminium, noir / plastique, blanc

L 985, B 80, H 1200

LED

warm
WHITE
4500lm



9 002759 993177

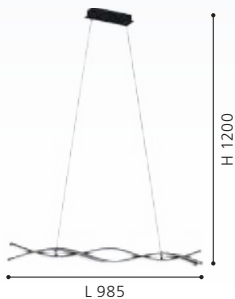

99316 LASANA 3

wall / ceiling light; steel, aluminium, black / plastic, white
Wand- / Deckenleuchte; Stahl, Alu, schwarz / Kunststoff, weiss
applique / plafonnier; acier, aluminium, noir / plastique, blanc

L 500, B 500, H 95

LED

warm
WHITE
2800lm



9 002759 993160

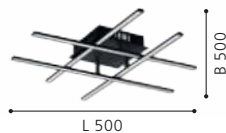

99315 LASANA 3

wall / ceiling light; steel, aluminium, black / plastic, white
Wand- / Deckenleuchte; Stahl, Alu, schwarz / Kunststoff, weiss
applique / plafonnier; acier, aluminium, noir / plastique, blanc

L 500, B 145, H 90

LED

warm
WHITE
1500lm



9 002759 993153





99319

LED



99318

LED

99319 LASANA 3

floor light; steel, aluminium, black / plastic, white
 Stehleuchte; Stahl, Alu, schwarz / Kunststoff, weiss
 lampadaire; acier, aluminium, noir / plastique, blanc

L 250, B 130, H 1420, Base: B 230, T 150



36W 4700lm



9 002759 993191



99318 LASANA 3

table light; steel, aluminium, black / plastic, white
 Tischleuchte; Stahl, Alu, schwarz / Kunststoff, weiss
 luminaire de table; acier, aluminium, noir / plastique, blanc

L 160, B 100, H 460, Base: B 180, T 100



11,5W 1280lm



9 002759 993184





95147

LED



32048

LED

95147 LASANA

pendant light; aluminium, steel, chrome / plastic, white
 Hängeleuchte; Alu, Stahl, chrom / Kunststoff, weiss
 luminaire en suspension; aluminium, acier, chrome / plastique, blanc

L 900, H 1100

LED

30W

warm
WHITE

3500lm



9 002759 951474

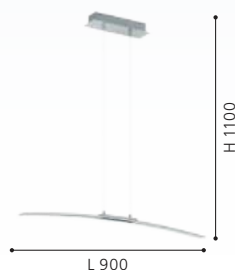

32048 LASANA

pendant light; aluminium, steel, chrome / plastic, white
 Hängeleuchte; Alu, Stahl, chrom / Kunststoff, weiss
 luminaire en suspension; aluminium, acier, chrome / plastique, blanc

L 900, H 1000

LED

15W

warm
WHITE

1800lm



9 002759 320485

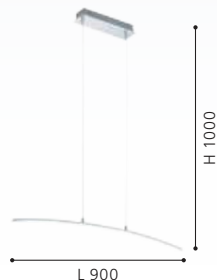

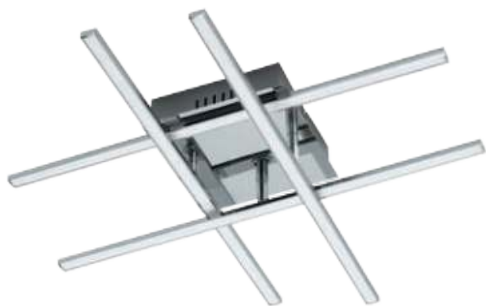

95568

LED



95567

LED



96866

LED

95568 LASANA 1

wall / ceiling light; steel, chrome / plastic, white
Wand- / Deckenleuchte; Stahl, chrom / Kunststoff, weiss
applique / plafonnier; acier, chrome / plastique, blanc

L 500, B 500, H 95



4x 5,3W 2800lm



9 002759 955687

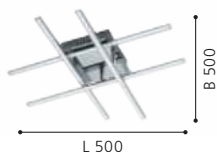

95567 LASANA 1

wall / ceiling light; steel, chrome / plastic, white
Wand- / Deckenleuchte; Stahl, chrom / Kunststoff, weiss
applique / plafonnier; acier, chrome / plastique, blanc

L 500, B 160, H 95



3x 3,5W 1500lm



9 002759 955670

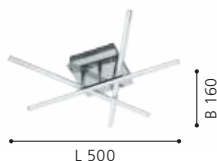

96866 TARANDELL

pendant light; aluminium, steel, chrome / plastic, satiné
Hängeleuchte; Alu, Stahl, chrom / Kunststoff, satiniert
luminaire en suspension; aluminium, acier, chrome / plastique, satiné

L 1180, B 60, H 930 - 1620



2x 12,5W 3300lm



9 002759 968663





99322

LED



99321

LED



99323

LED

99322 RONCADE 1

wall / ceiling light; steel, aluminium, black / plastic, white
Wand- / Deckenleuchte; Stahl, Alu, schwarz / Kunststoff, weiss
applique / plafonnier; acier, aluminium, noir / plastique, blanc

L 1160, B 180, H 115



36W 4600lm

99321 RONCADE 1

wall / ceiling light; steel, aluminium, black / plastic, white
Wand- / Deckenleuchte; Stahl, Alu, schwarz / Kunststoff, weiss
applique / plafonnier; acier, aluminium, noir / plastique, blanc

L 650, B 130, H 45



21W 2800lm

99323 SELVINA 1

ceiling light; steel, aluminium, black / plastic, white
Deckenleuchte; Stahl, Alu, schwarz / Kunststoff, weiss
plafonnier; acier, aluminium, noir / plastique, blanc

L 690, B 280, H 150



19W 2700lm



9 002759 993221



L 1160



9 002759 993214



L 650



9 002759 993238



L 690



31996



31995



96329



31996 RONCADE

wall / ceiling light; aluminium, steel, chrome / plastic, white
Wand- / Deckenleuchte; Alu, Stahl, chrom / Kunststoff, weiss
applique / plafonnier; aluminium, acier, chrome / plastique, blanc

L 1085, B 160, H 125



32W 4500lm

31995 RONCADE

wall / ceiling light; aluminium, steel, chrome / plastic, white
Wand- / Deckenleuchte; Alu, Stahl, chrom / Kunststoff, weiss
applique / plafonnier; aluminium, acier, chrome / plastique, blanc

L 650, B 130, H 45



21W 2800lm

96329 SELVINA

ceiling light; aluminium, chrome / plastic, white
Deckenleuchte; Alu, chrom / Kunststoff, weiss
plafonnier; aluminium, chrome / plastique, blanc

L 700, B 420, H 150



19W 2700lm



9 002759 319960



9 002759 319953

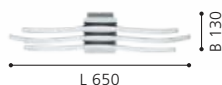

9 002759 963293





96308

LED



96327

LED



96326

LED

96308 SELVINA

ceiling light; aluminium, chrome / plastic, white
Deckenleuchte; Alu, chrom / Kunststoff, weiss
plafonnier; aluminium, chrome / plastique, blanc

L 745, B 175, H 85

LED

warm
WHITE
2900lm



9 002759 963088



96327 VALMORA

ceiling light; aluminium, chrome / plastic, white
Deckenleuchte; Alu, chrom / Kunststoff, weiss
plafonnier; aluminium, chrome / plastique, blanc

L 560, B 560, H 105

LED

warm
WHITE
2450lm



9 002759 963279

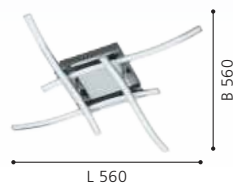

96326 VALMORA

ceiling light; aluminium, chrome / plastic, white
Deckenleuchte; Alu, chrom / Kunststoff, weiss
plafonnier; aluminium, chrome / plastique, blanc

L 590, B 125, H 90

LED

warm
WHITE
1700lm



9 002759 963262





96332



96305

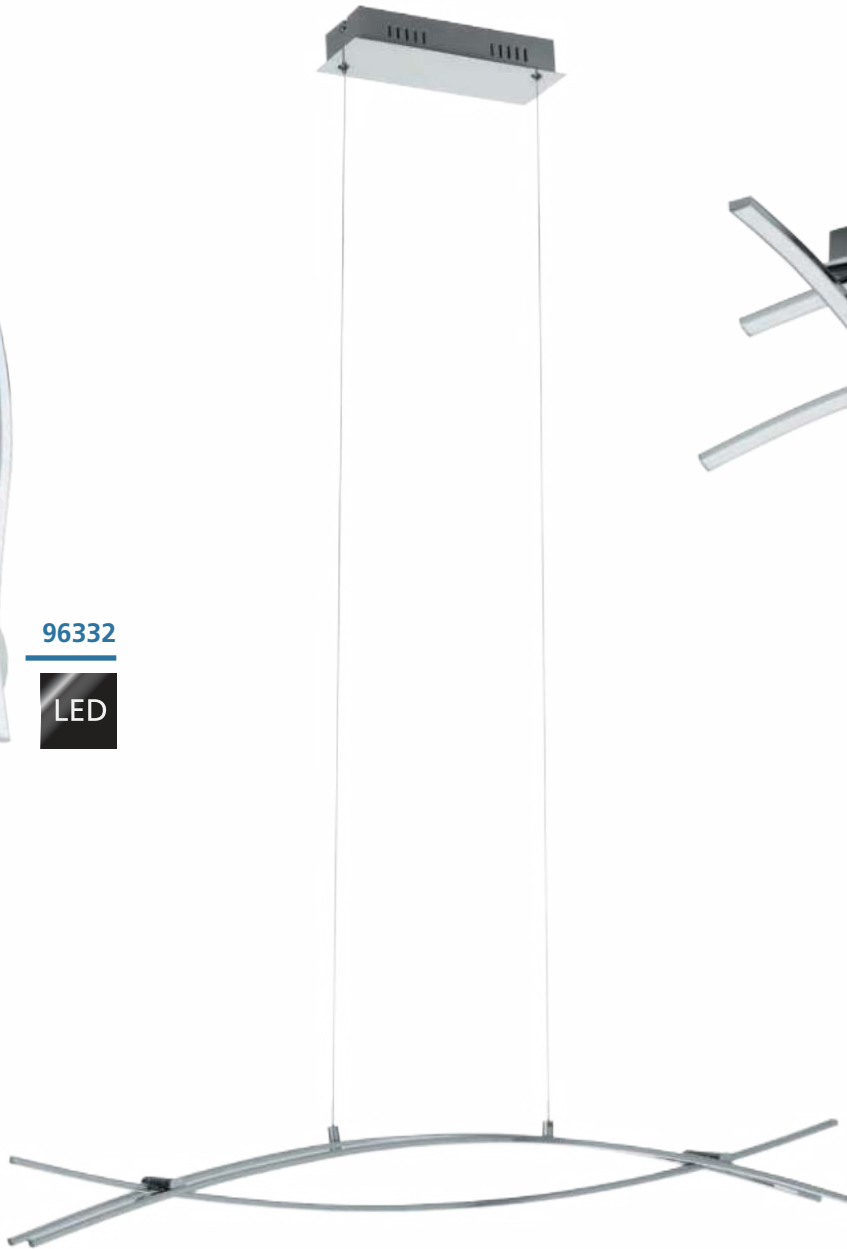

96331



96332 VALMORA

wall light; aluminium, chrome / plastic, white
Wandleuchte; Alu, chrom / Kunststoff, weiss
applique; aluminium, chrome / plastique, blanc

L 115, H 450, A 90



9W 1250lm



9 002759 963323



96331 NEVADO

pendant light; aluminium, chrome / plastic, white
Hängeleuchte; Alu, chrom / Kunststoff, weiss
luminaire en suspension; aluminium, chrome / plastique, blanc

L 900, B 80, H 1100



23,6W 3400lm



9 002759 963316

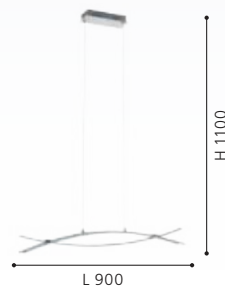

96305 NEVADO

ceiling light; aluminium, chrome / plastic, white
Deckenleuchte; Alu, chrom / Kunststoff, weiss
plafonnier; aluminium, chrome / plastique, blanc

L 500, B 500, H 115



18W 2450lm



9 002759 963057

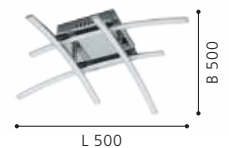



96306

LED



98889

LED



99559

LED

96306 SELVINA

ceiling light; aluminium, chrome / plastic, white
Deckenleuchte; Alu, chrom / Kunststoff, weiss
plafonnier; aluminium, chrome / plastique, blanc

L 460, B 390, H 380



28W

3600lm

98889 PALOZZA 1

wall light; aluminium, satin nickel / plastic, white
Wandleuchte; Alu, nickel-matt / Kunststoff, weiss
applique; aluminium, nickel mat / plastique, blanc

L 170, H 425, A 60



10W

1300lm

99559 PALOZZA 1

table light; aluminium, satin nickel / plastic, white
Tischleuchte; Alu, nickel-matt / Kunststoff, weiss
luminaire de table; aluminium, nickel mat / plastique, blanc

L 150, B 110, H 420



11W

1400lm



9 002759 963064

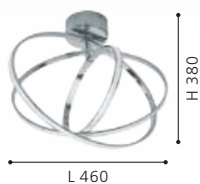

9 002759 988890



9 002759 995591

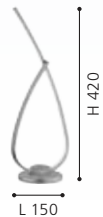

31997 RONCADE

table light; aluminium, steel, chrome / plastic, white
Tischleuchte; Alu, Stahl, chrom / Kunststoff, weiss
luminaire de table; aluminium, acier, chrome / plastique, blanc

L 195, B 150, H 335

LED

8,8W

warm
WHITE

866lm



9 002759 319977



31997

LED

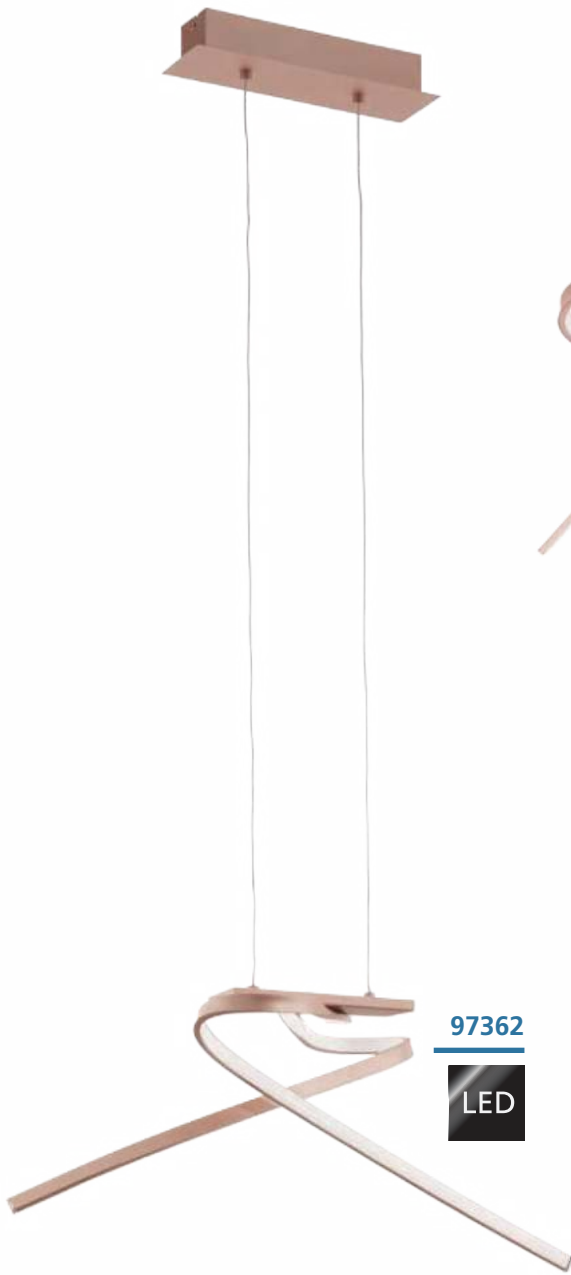

97362



97361



97363



97362 PALOZZA

pendant light; aluminium, rose gold / plastic, white
 Hängeleuchte; Alu, roségold / Kunststoff, weiss
 luminaire en suspension; aluminium, rose or / plastique, blanc

L 705, B 315, H 1100



19W



2600lm



9 002759 973629

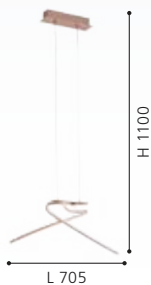

97361 PALOZZA

ceiling light; aluminium, rose gold / plastic, white
 Deckenleuchte; Alu, roségold / Kunststoff, weiss
 plafonnier; aluminium, rose or / plastique, blanc

L 705, B 315, H 125



19W



2700lm



9 002759 973612

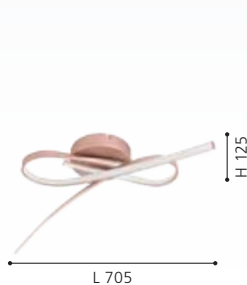

97363 PALOZZA

wall light; aluminium, rose gold / plastic, white
 Wandleuchte; Alu, roségold / Kunststoff, weiss
 applique; aluminium, rose or / plastique, blanc

L 170, H 425, A 60



9W



1400lm



9 002759 973636





97364

LED

97364 PALOZZA

table light; aluminium, rose gold / plastic, white
Tischleuchte; Alu, roségold / Kunststoff, weiss
luminaire de table; aluminium, rose or / plastique, blanc

H 380, Ø 185, Base: Ø 150

LED

8,8W

warm
WHITE

866lm



9 002759 973643

Ø 185



H 380

Ø 150

LIGHTING FAMILIES

GLASS CHANDELIERS
GLASLUSTER
LUSTRES EN VERRE

SPARKLING

Extravagant lighting – our glass chandeliers will give you light in a new diversity while ensuring an extraordinary ambience. Our chandeliers are true jewels on your ceiling and spread their elegance in your entire living area.

FUNKELN

Beleuchtung der Extravaganz – Mit unseren Glaslustern erleben Sie Licht in neuer Vielfalt und sorgen für ein außergewöhnliches Ambiente. Unsere Kronleuchter werden zum wahren Schmuckstück und bringen Eleganz in all Ihre Wohnbereiche.



DU SCINTILLEMENT

Un éclairage riche en extravagance – Avec nos lustres en verre, vous faites l'expérience de la lumière dans une nouvelle multiplicité et vous assurez une ambiance extraordinaire. Nos plafonniers lustres en deviennent de vrais bijoux et prêtent de l'élégance à tous vos espaces d'habitat.



OVERVIEW

LIGHTING FAMILIES / GLASS CHANDELIERS



BASILANO 1
p. 320-321



BASILANO
p. 322-323



CARPENTO
p. 324



This product is available in different colors and shapes./ Dieser Artikel ist in unterschiedlichen Farben und Formen verfügbar.
Cet article est disponible en différentes couleurs et formes.





39103 BASILANO 1

pendant light; steel, chrome / glass, clear
 Hängeleuchte; Stahl, chrom / Glas, klar
 luminaire en suspension; acier, chrome / verre, transparent

H 1500, Ø 1000



E14 18x 40W



9 002759 391034



H 1500

Ø 1000

39101 BASILANO 1

pendant light; steel, chrome / glass, clear
 Hängeleuchte; Stahl, chrom / Glas, klar
 luminaire en suspension; acier, chrome / verre, transparent

H 1300, Ø 820



E14 8x 40W



9 002759 391010



H 1300

Ø 820

39099 BASILANO 1

pendant light; steel, chrome / glass, clear
 Hängeleuchte; Stahl, chrom / Glas, klar
 luminaire en suspension; acier, chrome / verre, transparent

H 1300, Ø 720



E14 6x 40W



9 002759 390990



H 1300

Ø 720



39099



39102

39102 BASILANO 1

pendant light; steel, chrome / glass, clear

Hängeleuchte; Stahl, chrom / Glas, klar

luminaire en suspension; acier, chrome / verre, transparent

H 1500, Ø 1000



E14



12x 40W



9 002759 391027



H 1500

Ø 1000



39095



39092

39095 BASILANO

pendant light; steel, chrome / glass, cognac
 Hängeleuchte; Stahl, chrom / Glas, cognac
 luminaire en suspension; acier, chrome / verre, cognac

H 1500, Ø 1000



9 002759 390952



39092 BASILANO

pendant light; steel, chrome / glass, cognac
 Hängeleuchte; Stahl, chrom / Glas, cognac
 luminaire en suspension; acier, chrome / verre, cognac

H 1300, Ø 720



9 002759 390921





39093



39094

39093 BASILANO

pendant light; steel, chrome / glass, cognac
 Hängeleuchte; Stahl, chrom / Glas, cognac
 luminaire en suspension; acier, chrome / verre, cognac

H 1300, Ø 820



E14 8x 40W



9 002759 390938



39094 BASILANO

pendant light; steel, chrome / glass, cognac
 Hängeleuchte; Stahl, chrom / Glas, cognac
 luminaire en suspension; acier, chrome / verre, cognac

H 1500, Ø 1000



E14 12x 40W



9 002759 390945





39113

39113 CARPENTO

pendant light; steel, chrome / glass, white
 Hängeleuchte; Stahl, chrom / Glas, weiss
 luminaire en suspension; acier, chrome / verre, blanc

H 1200, Ø 590



E14 5x 40W



9 002759 391133



39114 CARPENTO

pendant light; steel, chrome / glass, white
 Hängeleuchte; Stahl, chrom / Glas, weiss
 luminaire en suspension; acier, chrome / verre, blanc

H 1300, Ø 700



E14 8x 40W



9 002759 391140





39114



HANGING & PENDANT LUMINAIRES

HÄNGE- & PENDELLEUCHTEN
LUMINAIRES SUSPENSIONS

SUSPENDED LIGHTING

Our wide variety of suspended and pendant luminaires contain classical as well as extravagant designs and supply any furnishing style. Set beautiful accents with your favourites and give your home a special atmosphere.

BELEUCHTUNG ZUM ABHÄNGEN

Unser breitgefächertes Hänge- und Pendelleuchten-Sortiment beinhaltet sowohl klassische als auch extravagante Designs und bedient jeden Einrichtungsstil. Setzen Sie mit Ihren Favoriten schöne Akzente und verleihen Sie Ihrem Zuhause eine besondere Atmosphäre.

















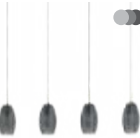







































ÉCLAIRAGES SUSPENDUS

Notre large gamme d'éclairages suspendus et pendulaires comprend aussi bien des designs classiques qu'extravagants et est adaptée à tout style d'ameublement. Mettez avec vos favoris de beaux accents et donnez une atmosphère particulière à votre intérieur.



OVERVIEW

HANGING & PENDANT LUMINAIRES

 <p>OILELLA p. 330-331</p>	 <p>AGUILARES p. 332</p>	 <p>LEBALIO p. 333</p>	 <p>MARYVILLA p. 334</p>	 <p>ALOBRASE p. 335-339</p>	 <p>BATISTA p. 335</p>	 <p>CADAQUES p. 340</p>	 <p>CADAQUES 1 p. 340</p>
 <p>TORRONTES p. 340</p>	 <p>ARISCANI p. 342-343</p>	 <p>MURMILLO p. 344</p>	 <p>FARSALA p. 345</p>	 <p>BELESER p. 346-766</p>	 <p>MANTUNALLE 1 p. 347</p>	 <p>MANTUNALLE p. 348</p>	 <p>SELVINO p. 350-351</p>
 <p>ALBARACCIN p. 352-353</p>	 <p>LAGUNITAS p. 354</p>	 <p>CERASELLA p. 355</p>	 <p>ROCAMAR p. 356, 358</p>	 <p>ROCAMAR 1 p. 357-358</p>	 <p>CORETTO p. 357</p>	 <p>LONCINO 1 p. 359</p>	 <p>ALEANDRO 1 p. 360</p>
 <p>ROMAGNESE p. 360</p>	 <p>VALLASPRA p. 361</p>	 <p>BATISTA 3 p. 361</p>	 <p>BOLSANO p. 362</p>	 <p>CLEMENTE p. 363</p>	 <p>CARDITO 1 p. 364</p>	 <p>FEDRA 2 p. 365</p>	 <p>VARRAZO p. 365</p>
 <p>LUBERIO p. 366</p>	 <p>MONTEFIO 1 p. 366-367</p>	 <p>MIOGLIA 1 p. 368</p>	 <p>CONESSA p. 368-369</p>	 <p>ENALURI p. 370</p>	 <p>CARTAMA p. 371</p>	 <p>MONTEFINO p. 372</p>	 <p>CORTENOVA p. 374</p>
 <p>POZUETA p. 377</p>	 <p>BOCADELLA p. 378</p>	 <p>MEZZANA p. 378</p>	 <p>GRADOLI p. 380</p>	 <p>GRADOLI 1 p. 381</p>	 <p>MANIZALES p. 381</p>	 <p>CUMIOLE p. 382</p>	 <p>MONTEBALDO p. 383</p>
 <p>BITACHITO p. 383</p>	 <p>CORTADERAS p. 384</p>	 <p>SARONA p. 386</p>	 <p>LOBATIA p. 387</p>	 <p>SILVARES p. 388</p>	 <p>TAREGA p. 389</p>	 <p>GATUELA 1 p. 390</p>	 <p>GATUELA p. 391</p>

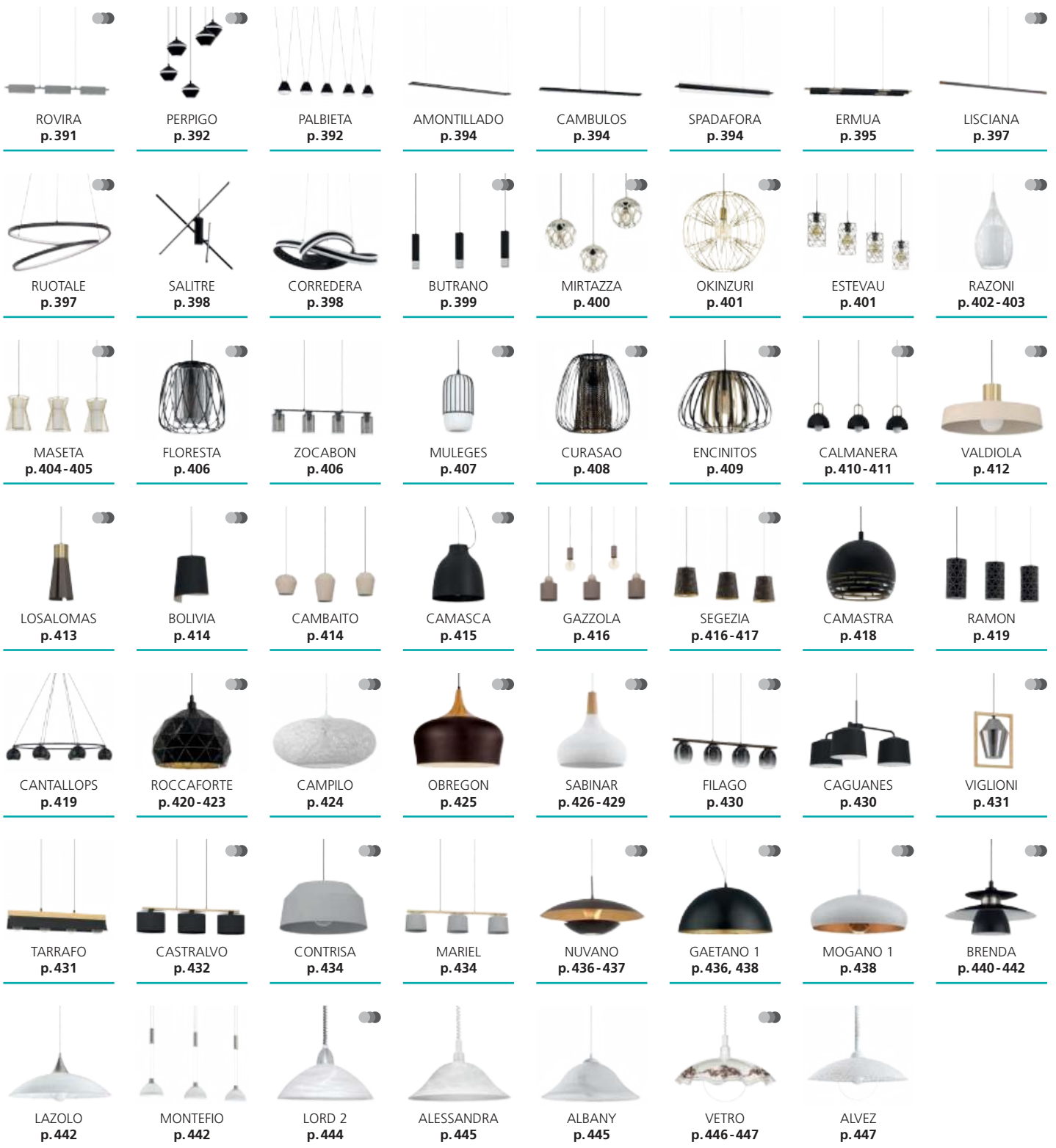

 This product is available in different colors and shapes./ Dieser Artikel ist in unterschiedlichen Farben und Formen verfügbar.
Cet article est disponible en différentes couleurs et formes.



99614 OILELLA

pendant light; steel, black, brass / glass vaporized, black-brown-transparent

Hängeleuchte; Stahl, schwarz, messing / Glas bedampft, schwarz-braun-transparent

luminaire en suspension; acier, noir, laiton / verre vaporisé, noir-marron-transparent

H 1100, Ø 190



E27

1x 40W



9 002759 996147



99615 OILELLA

pendant light; steel, black, brass / glass vaporized, black-brown-transparent

Hängeleuchte; Stahl, schwarz, messing / Glas bedampft, schwarz-braun-transparent

luminaire en suspension; acier, noir, laiton / verre vaporisé, noir-marron-transparent

L 950, B 190, H 1100



E27

3x 40W



9 002759 996154



99616 OILELLA

pendant light; steel, black, brass / glass vaporized, black-grey-transparent

Hängeleuchte; Stahl, schwarz, messing / Glas bedampft, schwarz-grau-transparent

luminaire en suspension; acier, noir, laiton / verre vaporisé, noir-gris-transparent

H 1100, Ø 190



E27

1x 40W



9 002759 996161

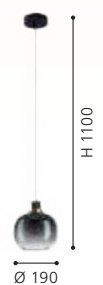



99617



99617 OILELLA

pendant light; steel, black, brass / glass vaporized,
black-grey-transparent

Hängeleuchte; Stahl, schwarz, messing / Glas bedampft,
schwarz-grau-transparent

luminaire en suspension; acier, noir, laiton / verre vaporisé,
noir-gris-transparent

L 950, B 190, H 1100



E27



3x 40W



DESIGN
HIGHLIGHT
DETAIL



900195



900196

900195 AGUILARES

pendant light; steel, black / glass vaporized, black-grey-transparent

Hängeleuchte; Stahl, schwarz / Glas bedampft, schwarz-grau-transparent

luminaire en suspension; acier, noir / verre vaporisé, noir-gris-transparent

L 840, B 195, H 1045



E27



3x 40W



9 008606 235551



900196 AGUILARES

pendant light; steel, black / glass vaporized, black-grey-transparent

Hängeleuchte; Stahl, schwarz / Glas bedampft, schwarz-grau-transparent

luminaire en suspension; acier, noir / verre vaporisé, noir-gris-transparent

H 1100, Ø 430



E27



3x 40W



9 008606 235568





99314

99314 LEBALIO

pendant light; steel, bronzed / glass vaporized, black-transparent

Hängeleuchte; Stahl, brüniert / Glas bedampft, schwarz-transparent

luminaire en suspension; acier, brun / verre vaporisé, noir transparent

L 1125, B 195, H 1100



E27



3x 40W



9 002759 993146

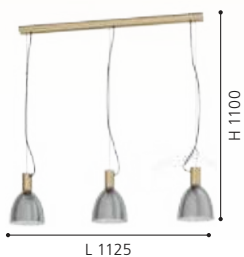

EGLO
RECOMMENDS
110001

99314

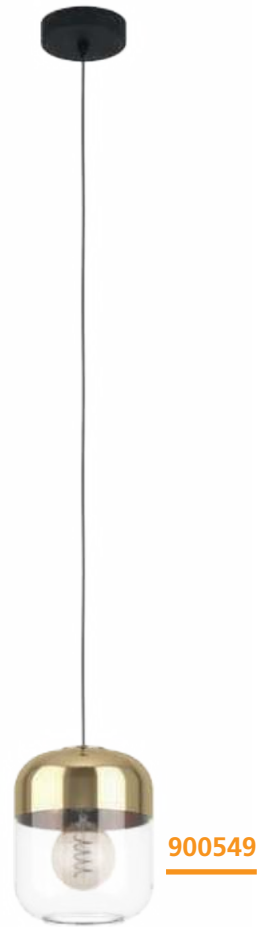

900549



900551



MARYVILLA

900549 MARYVILLA

pendant light; steel, black, bronzed / glass vaporized, clear, gold
 Hängeleuchte; Stahl, schwarz, brüniert / Glas bedampft, klar, gold
 luminaire en suspension; acier, noir, brun / verre vaporisé, transparent, or

H 1100, Ø 170



E27 1x 40W



9 008606 244553



900551 MARYVILLA

pendant light; steel, black, bronzed / glass vaporized, clear, gold
 Hängeleuchte; Stahl, schwarz, brüniert / Glas bedampft, klar, gold
 luminaire en suspension; acier, noir, brun / verre vaporisé, transparent, or

L 870, B 170, H 1100



E27 3x 40W



9 008606 244560





900506

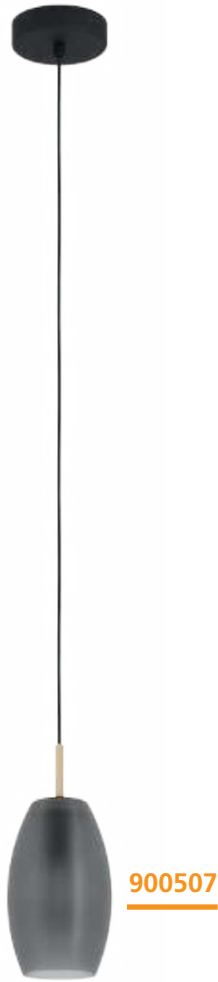

900507



900506 | 900507 | 900508



900508

900506 ALOBRASE

pendant light; steel, black, brushed brass / satin glass, grey matt
 Hängeleuchte; Stahl, schwarz, messing-gebürstet / Glas satiniert, grau matt
 luminaire en suspension; acier, noir, laiton brossé / verre satiné, gris mat

H 1100, Ø 200



E27 1x 40W



9 008606 244362

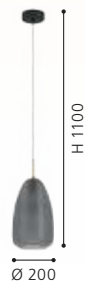

900507 BATISTA

pendant light; steel, black, brushed brass / satin glass, grey matt
 Hängeleuchte; Stahl, schwarz, messing-gebürstet / Glas satiniert, grau matt
 luminaire en suspension; acier, noir, laiton brossé / verre satiné, gris mat

H 1100, Ø 120



E27 1x 40W



9 008606 244379



900508 BATISTA

pendant light; steel, black, brushed brass / satin glass, grey matt
 Hängeleuchte; Stahl, schwarz, messing-gebürstet / Glas satiniert, grau matt
 luminaire en suspension; acier, noir, laiton brossé / verre satiné, gris mat

L 945, B 120, H 1100



E27 4x 40W



9 008606 244386

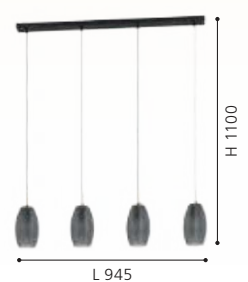



98614



98616



ALOBRASE

98614 ALOBRASE

pendant light; steel, chrome / glass vaporized, black-transparent
Hängeleuchte; Stahl, chrom / Glas bedampft, schwarz-transparent
luminaire en suspension; acier, chrome / verre vaporisé, noir transparent

H 1100, Ø 300



E27 1x 40W



9 002759 986148



98616 ALOBRASE

pendant light; steel, chrome / glass vaporized, black-transparent
Hängeleuchte; Stahl, chrom / Glas bedampft, schwarz-transparent
luminaire en suspension; acier, chrome / verre vaporisé, noir transparent

L 1080, B 150, H 1100



E27 4x 40W



9 002759 986162



98615 ALOBRASE

pendant light; steel, chrome / glass vaporized, black-transparent
Hängeleuchte; Stahl, chrom / Glas bedampft, schwarz-transparent
luminaire en suspension; acier, chrome / verre vaporisé, noir transparent

H 1100, Ø 200



E27 1x 40W



9 002759 986155



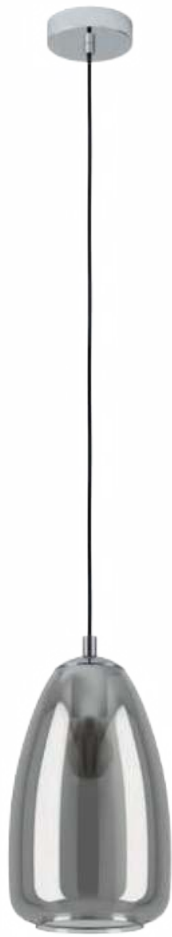

98615

98617 ALOBRASE

pendant light; steel, chrome / glass vaporized, black-transparent
Hängeleuchte; Stahl, chrom / Glas bedampft, schwarz-transparent
luminaire en suspension; acier, chrome / verre vaporisé, noir transparent

H 1500, Ø 540



E27



5x 40W



9 002759 986179

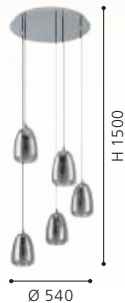

98617



98647



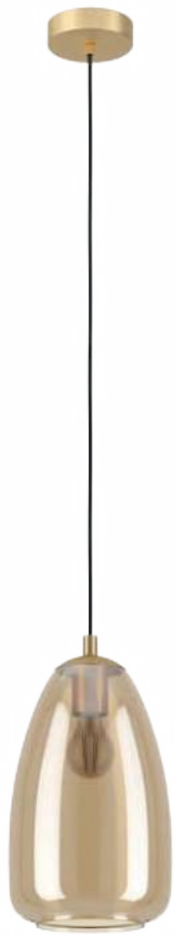

98648



98649

98647 ALOBRASE

pendant light; steel, brushed brass / glass vaporized, amber
Hängeleuchte; Stahl, messing-gebürstet / Glas bedampft, amber
luminaire en suspension; acier, laiton brossé / verre vaporisé, ambre

H 1100, Ø 300



9 002759 986476



98648 ALOBRASE

pendant light; steel, brushed brass / glass vaporized, amber
Hängeleuchte; Stahl, messing-gebürstet / Glas bedampft, amber
luminaire en suspension; acier, laiton brossé / verre vaporisé, ambre

H 1100, Ø 200



9 002759 986483



98649 ALOBRASE

pendant light; steel, brushed brass / glass vaporized, amber
Hängeleuchte; Stahl, messing-gebürstet / Glas bedampft, amber
luminaire en suspension; acier, laiton brossé / verre vaporisé, ambre

L 1080, B 150, H 1100



9 002759 986490

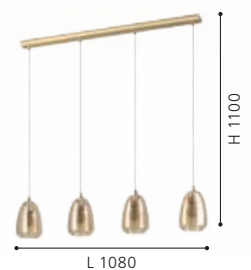



98582 | 98585

98582



98585



98291

98582 CADAQUES

pendant light; steel, black / smoked glass, black-transparent
Hängeleuchte; Stahl, schwarz / Rauchglas, schwarz-transparent
luminaire en suspension; acier, noir / verre fumé, noir transparent

H 1100, Ø 180



9 002759 985820



98585 CADAQUES 1

pendant light; steel, black / smoked glass, black-transparent
Hängeleuchte; Stahl, schwarz / Rauchglas, schwarz-transparent
luminaire en suspension; acier, noir / verre fumé, noir transparent

H 1100, Ø 160



9 002759 985851



98291 TORRONTES

pendant light; steel, nickel-nero / smoked glass, black-transparent
Hängeleuchte; Stahl, nickel-nero / Rauchglas, schwarz-transparent
luminaire en suspension; acier, nickel noir / verre fumé, noir transparent

H 1100, Ø 345

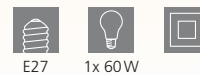

9 002759 982911

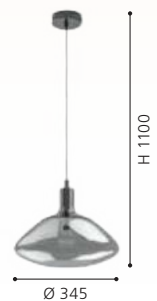

98291





ARISCANI



98651 ARISCANI

pendant light; steel, black / glass vaporized, black-transparent
Hängeleuchte; Stahl, schwarz / Glas bedampft, schwarz-transparent
luminaire en suspension; acier, noir / verre vaporisé, noir transparent

H 1100, Ø 200



E27 1x 40W



9 002759 986513



98652 ARISCANI

pendant light; steel, black / glass vaporized, black-transparent
Hängeleuchte; Stahl, schwarz / Glas bedampft, schwarz-transparent
luminaire en suspension; acier, noir / verre vaporisé, noir transparent

L 765, B 165, H 1100



E27 3x 40W



9 002759 986520

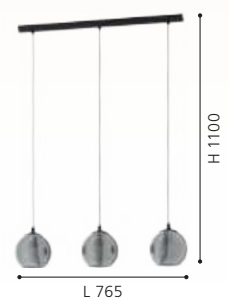



98654



98653

98654 ARISCANI

pendant light; steel, black / glass vaporized, black-transparent
 Hängeleuchte; Stahl, schwarz / Glas bedampft, schwarz-transparent
 luminaire en suspension; acier, noir / verre vaporisé, noir transparent

H 1700, Ø 655



E27 10x 40W



9 002759 986544



98653 ARISCANI

pendant light; steel, black / glass vaporized, black-transparent
 Hängeleuchte; Stahl, schwarz / Glas bedampft, schwarz-transparent
 luminaire en suspension; acier, noir / verre vaporisé, noir transparent

H 1100, Ø 425



E27 3x 40W



9 002759 986537

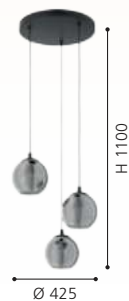



96774



96773



MURMILLO

96774 MURMILLO

pendant light; steel, chrome / smoked glass, black-transparent
 Hängeleuchte; Stahl, chrom / Rauchglas, schwarz-transparent
 luminaire en suspension; acier, chrome / verre fumé, noir transparent

L 770, B 170, H 1500



E27



3x 28W



9 002759 967741



96773 MURMILLO

pendant light; steel, chrome / smoked glass, black-transparent
 Hängeleuchte; Stahl, chrom / Rauchglas, schwarz-transparent
 luminaire en suspension; acier, chrome / verre fumé, noir transparent

H 1500, Ø 170



E27



1x 28W



9 002759 967734





96343

LED

96344

LED

96345

LED

96343 FARSALA

pendant light; steel, satin nickel / smoked glass, granilla, black-transparent, clear

Hängeleuchte; Stahl, nickel-matt / Rauchglas, Granille, schwarz-transparent, klar

luminaire en suspension; acier, nickel mat / verre fumé, granité, noir transparent, transparent

H 1100, Ø 125



G9



1x 3W



warm WHITE

1x

320lm



9 002759 963439



96344 FARSALA

pendant light; steel, satin nickel / smoked glass, granilla, black-transparent, clear

Hängeleuchte; Stahl, nickel-matt / Rauchglas, Granille, schwarz-transparent, klar

luminaire en suspension; acier, nickel mat / verre fumé, granité, noir transparent, transparent

L 975, B 100, H 1100



G9



4x 3W



warm WHITE

4x

320lm



9 002759 963446



Ø 125

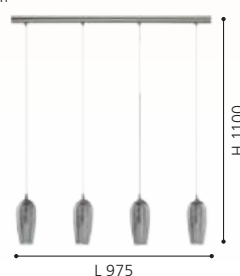

L 975

96345 FARSALA

pendant light; steel, satin nickel / smoked glass, granilla, black-transparent, clear

Hängeleuchte; Stahl, nickel-matt / Rauchglas, Granille, schwarz-transparent, klar

luminaire en suspension; acier, nickel mat / verre fumé, granité, noir transparent, transparent

H 1500, Ø 350



G9



5x 3W



warm WHITE

5x

320lm



9 002759 963453



Ø 350



98384



DESIGN
HIGHLIGHT
DETAIL

98384 BELESER

pendant light; steel, black / glass vaporized, black-transparent
Hängeleuchte; Stahl, schwarz / Glas bedampft, schwarz-transparent

luminaire en suspension; acier, noir / verre vaporisé, noir transparent

L 905, B 205, H 1100



E27



3x 60W



9 002759 983840





98384 | 99371



99372



99371



99372

99371 MANTUNALLE 1

pendant light; steel, black / glass vaporized, black-transparent
 Hängeleuchte; Stahl, schwarz / Glas bedampft, schwarz-transparent
 luminaire en suspension; acier, noir / verre vaporisé, noir transparent

H 1100, Ø 200



E27 1x 40W



9 002759 993719



99372 MANTUNALLE 1

pendant light; steel, black / glass vaporized, black-transparent
 Hängeleuchte; Stahl, schwarz / Glas bedampft, schwarz-transparent
 luminaire en suspension; acier, noir / verre vaporisé, noir transparent

L 1200, B 200, H 1100



E27 3x 40W



9 002759 993726

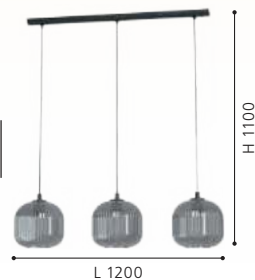

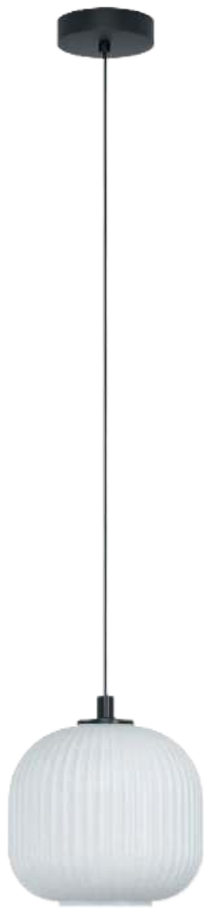

99366



99366



99368



99367 | 99368

99366 MANTUNALLE

pendant light; steel, black / glass, white
Hängeleuchte; Stahl, schwarz / Glas, weiss
luminaire en suspension; acier, noir / verre, blanc

H 1100, Ø 200



E27 1x 40W



9 002759 993665



99368 MANTUNALLE

pendant light; steel, black / glass, white
Hängeleuchte; Stahl, schwarz / Glas, weiss
luminaire en suspension; acier, noir / verre, blanc

H 1100, Ø 620



E27 3x 40W



9 002759 993689



99367 MANTUNALLE

pendant light; steel, black / glass, white
Hängeleuchte; Stahl, schwarz / Glas, weiss
luminaire en suspension; acier, noir / verre, blanc

L 1200, B 200, H 1100



E27 3x 40W



9 002759 993672



99367





98694



98694 | 98695



98695



98696

98694 SELVINO

pendant light; steel, satin nickel / glass vaporized, black-transparent

Hängeleuchte; Stahl, nickel-matt / Glas bedampft, schwarz-transparent

luminaire en suspension; acier, nickel mat / verre vaporisé, noir transparent

H 1100, Ø 100



E27

1x 15W



9 002759 986940



98695 SELVINO

pendant light; steel, satin nickel / glass vaporized, black-transparent

Hängeleuchte; Stahl, nickel-matt / Glas bedampft, schwarz-transparent

luminaire en suspension; acier, nickel mat / verre vaporisé, noir transparent

L 710, B 100, H 1100



E27

3x 15W



9 002759 986957



98696 SELVINO

pendant light; steel, satin nickel / glass vaporized, gold color

Hängeleuchte; Stahl, nickel-matt / Glas bedampft, goldfarben

luminaire en suspension; acier, nickel mat / verre vaporisé, couleur or

H 1100, Ø 100



E27

1x 15W



9 002759 986964

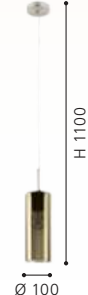



98696 | 98697 | 98698 |
98699

98697 SELVINO

pendant light; steel, satin nickel / glass vaporized, gold color
Hängeleuchte; Stahl, nickel-matt / Glas bedampft, goldfarben
luminaire en suspension; acier, nickel mat / verre vaporisé, couleur or

L 710, B 100, H 1100



9 002759 986971

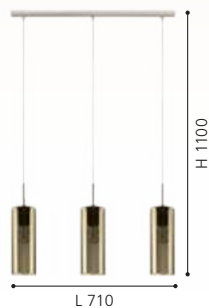

98698 SELVINO

pendant light; steel, satin nickel / glass vaporized, copper-coloured
Hängeleuchte; Stahl, nickel-matt / Glas bedampft, kupferfarben
luminaire en suspension; acier, nickel mat / verre vaporisé, cuivré

H 1100, Ø 100



9 002759 986988



98699 SELVINO

pendant light; steel, satin nickel / glass vaporized, copper-coloured
Hängeleuchte; Stahl, nickel-matt / Glas bedampft, kupferfarben
luminaire en suspension; acier, nickel mat / verre vaporisé, cuivré

L 710, B 100, H 1100



9 002759 986995



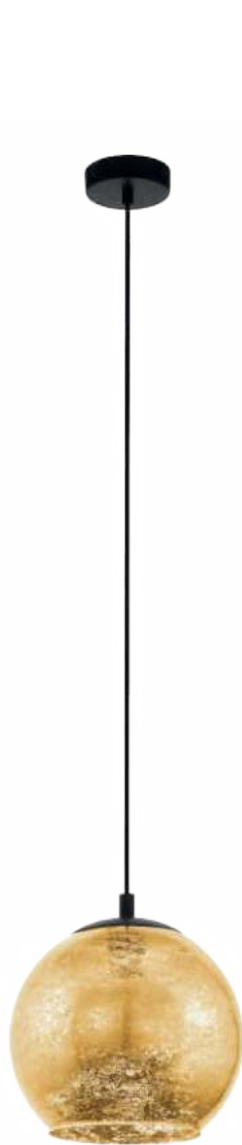

98523



98524



98526

98523 ALBARACCIN

pendant light; steel, black / glass, gold color
Hängeleuchte; Stahl, schwarz / Glas, goldfarben
luminaire en suspension; acier, noir / verre, couleur or

H 1100, Ø 270



E27 1x 40W



9 002759 985233

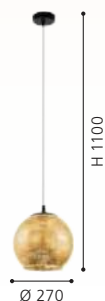

98524 ALBARACCIN

pendant light; steel, black / glass, gold color
Hängeleuchte; Stahl, schwarz / Glas, goldfarben
luminaire en suspension; acier, noir / verre, couleur or

H 1100, Ø 190



E27 1x 40W



9 002759 985240

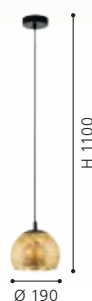

98526 ALBARACCIN

pendant light; steel, black / glass, gold color
Hängeleuchte; Stahl, schwarz / Glas, goldfarben
luminaire en suspension; acier, noir / verre, couleur or

H 1500, Ø 585



E27 5x 40W



9 002759 985264

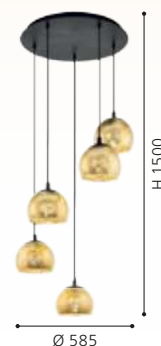



98525

98525 ALBARACCIN

pendant light; steel, black / glass, gold color

Hängeleuchte; Stahl, schwarz / Glas, goldfarben

luminaire en suspension; acier, noir / verre, couleur or

L 780, B 190, H 1100



E27



3x 40W



9 002759 985257





99654



99651

99654 LAGUNITAS

pendant light; steel, black, brass, gold / glass, clear
 Hängeleuchte; Stahl, schwarz, messing, gold / Glas, klar
 luminaire en suspension; acier, noir, laiton, or / verre, transparent

L 910, B 150, H 1100



E27



3x 40W



9 002759 996543



99651 LAGUNITAS

pendant light; steel, black, brass, gold / glass, clear
 Hängeleuchte; Stahl, schwarz, messing, gold / Glas, klar
 luminaire en suspension; acier, noir, laiton, or / verre, transparent

H 1100, Ø 150



E27



1x 40W



9 002759 996512





99628

LED

99629

LED



99628 CERASELLA

pendant light; steel, brushed brass / glass, clear
 Hängeleuchte; Stahl, messing-gebürstet / Glas, klar
 luminaire en suspension; acier, laiton brossé / verre, transparent

H 1100, Ø 200

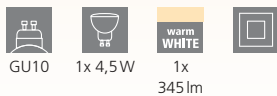

99629 CERASELLA

pendant light; steel, brushed brass / glass, clear
 Hängeleuchte; Stahl, messing-gebürstet / Glas, klar
 luminaire en suspension; acier, laiton brossé / verre, transparent

L 900, B 200, H 1100

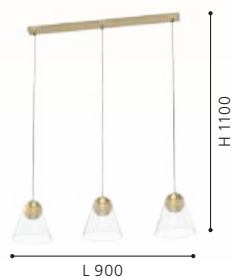

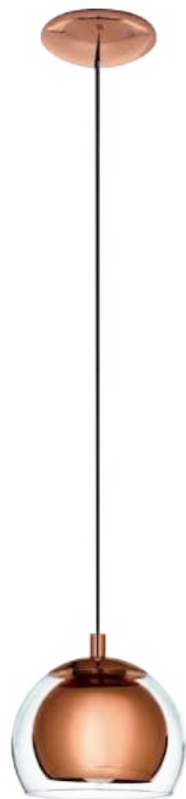

94589

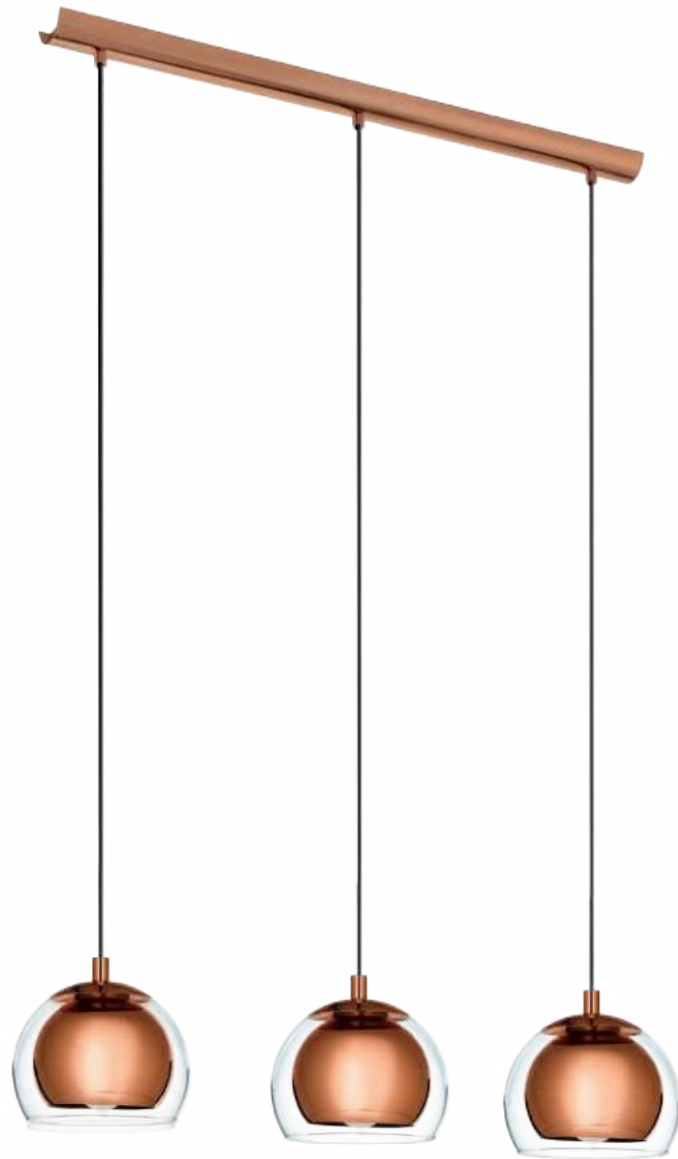

94591



94589 ROCAMAR

pendant light; steel, copper / glass, clear
Hängeleuchte; Stahl, kupfer / Glas, klar
luminaire en suspension; acier, cuivre / verre, transparent

H 1100, Ø 190



E27 1x 40W



9 002759 945893



94591 ROCAMAR

pendant light; steel, copper / glass, clear
Hängeleuchte; Stahl, kupfer / Glas, klar
luminaire en suspension; acier, cuivre / verre, transparent

L 780, B 190, H 1100



E27 3x 40W



9 002759 945916

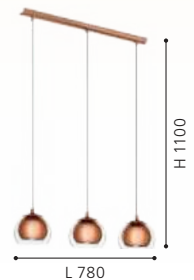



98595



93836



98595 ROCAMAR 1

pendant light; steel, copper / glass, clear
 Hängeleuchte; Stahl, kupfer / Glas, klar
 luminaire en suspension; acier, cuivre / verre, transparent

H 1500, Ø 585

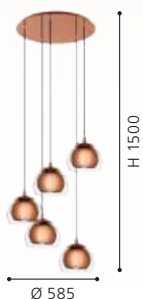

93836 CORETTO

pendant light; steel, brushed copper
 Hängeleuchte; Stahl, kupfer-gebürstet
 luminaire en suspension; acier, cuivre brossé

H 1100, Ø 170

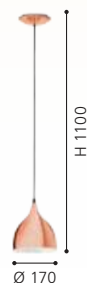



94592



94593



98596

94592 ROCAMAR

pendant light; steel, chrome / glass, clear
Hängeleuchte; Stahl, chrom / Glas, klar
luminaire en suspension; acier, chrome / verre, transparent

H 1100, Ø 190



9 002759 945923



94593 ROCAMAR

pendant light; steel, chrome / glass, clear
Hängeleuchte; Stahl, chrom / Glas, klar
luminaire en suspension; acier, chrome / verre, transparent

L 780, B 190, H 1100



9 002759 945930



98596 ROCAMAR 1

pendant light; steel, chrome / glass, clear
Hängeleuchte; Stahl, chrom / Glas, klar
luminaire en suspension; acier, chrome / verre, transparent

H 1500, Ø 585



9 002759 985967





94378



94377

DESIGN
HIGHLIGHT
DETAIL



LONGCINO 1

94378 LONGCINO 1

pendant light; steel, chrome / glass, satin glass, clear, white
Hängeleuchte; Stahl, chrom / Glas, Glas satiniert, klar, weiss
luminaire en suspension; acier, chrome / verre, verre satiné,
transparent, blanc

L 745, B 150, H 1100



9 002759 943783



94377 LONGCINO 1

pendant light; steel, chrome / glass, satin glass, clear, white
Hängeleuchte; Stahl, chrom / Glas, Glas satiniert, klar, weiss
luminaire en suspension; acier, chrome / verre, verre satiné,
transparent, blanc

L 150, B 150, H 1100



9 002759 943776





96528

LED

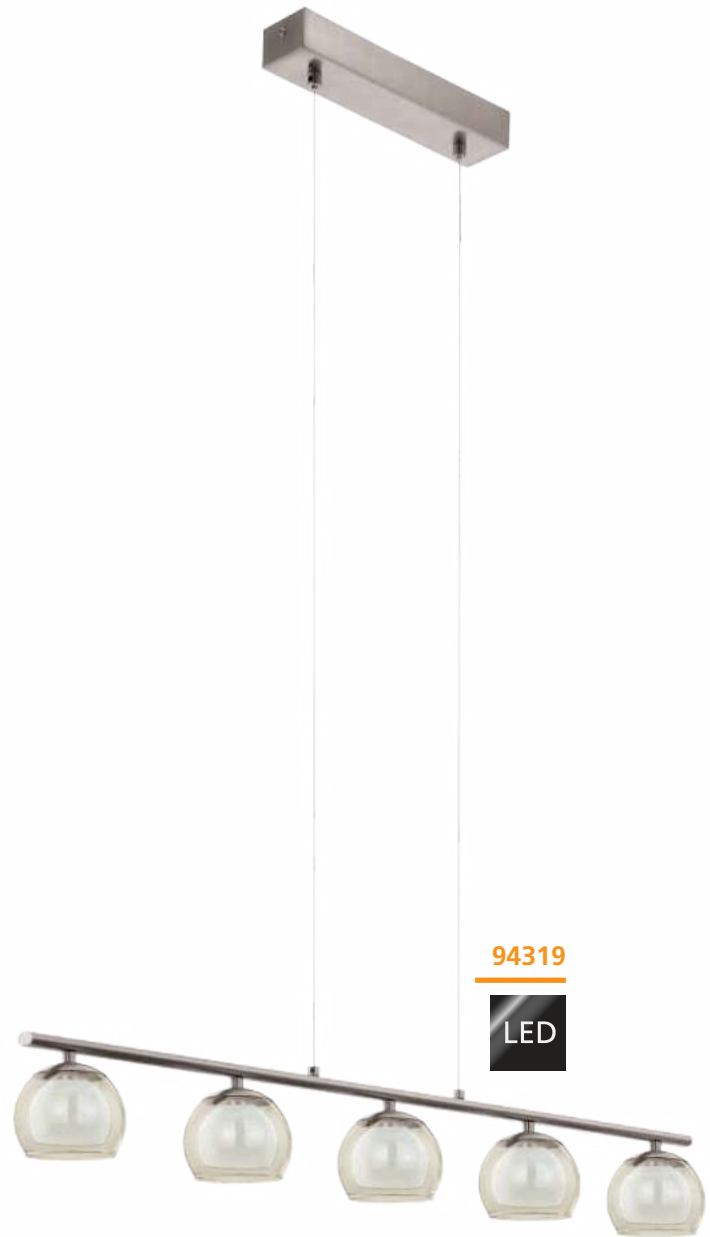

94319

LED

96528 ALEANDRO 1

pendant light; steel, chrome / glass opal-matt, white
 Hängeleuchte; Stahl, chrom / Glas opal-matt, weiss
 luminaire en suspension; acier, chrome / verre opale mat, blanc

L 800, B 120, H 860 - 1550



4x 4,5W 2000lm



9 002759 965280

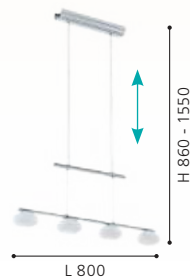

94319 ROMAGNESE

pendant light; steel, satin nickel / glass, satin glass, amber, white
 Hängeleuchte; Stahl, nickel-matt / Glas, Glas satiniert, ambre, weiss
 luminaire en suspension; acier, nickel mat / verre, verre satiné, ambre, blanc

L 900, B 105, H 1100



5x 3,3W 1700lm



9 002759 943196

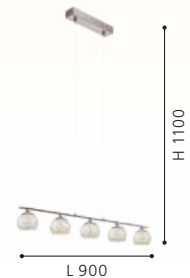



97793



97587



97793



97587

97793 VALLASPRA

pendant light; steel, champagne / glass opal-matt, white
Hängeleuchte; Stahl, champagner / Glas opal-matt, weiss
luminaire en suspension; acier, champagne / verre opale mat, blanc

L 910, B 165, H 1100



9 002759 977931

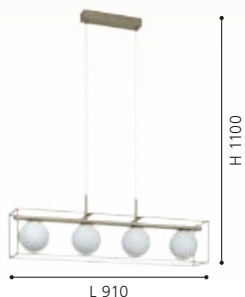

97587 BATISTA 3

pendant light; steel, satin nickel / glass wiping technique, white
Hängeleuchte; Stahl, nickel-matt / Glas Wischtechnik, weiss
luminaire en suspension; acier, nickel mat / technique de verre essuyé, blanc

L 1020, B 120, H 1100



9 002759 975876





92762



92761

92762 BOLSANO

pendant light; steel, chrome / satin glass, glass, white, clear
 Hängeleuchte; Stahl, chrom / Glas satiniert, Glas, weiss, klar
 luminaire en suspension; acier, chrome / verre satiné, verre, blanc, transparent

H 1300, Ø 505



92761 BOLSANO

pendant light; steel, chrome / satin glass, glass, white, clear
 Hängeleuchte; Stahl, chrom / Glas satiniert, Glas, weiss, klar
 luminaire en suspension; acier, chrome / verre satiné, verre, blanc, transparent

H 1300, Ø 200





CLEMENTE

95286



95287

95286 CLEMENTE

pendant light; steel, chrome / brilliant glass, clear

Hängeleuchte; Stahl, chrom / Brillantglas, klar

luminaire en suspension; acier, chrome / verre brillant, transparent

H 1100, Ø 350



9 002759 952860

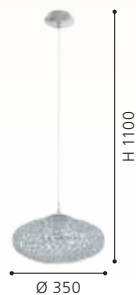

95287 CLEMENTE

pendant light; steel, chrome / brilliant glass, clear

Hängeleuchte; Stahl, chrom / Brillantglas, klar

luminaire en suspension; acier, chrome / verre brillant, transparent

H 1100, Ø 540



9 002759 952877





93625

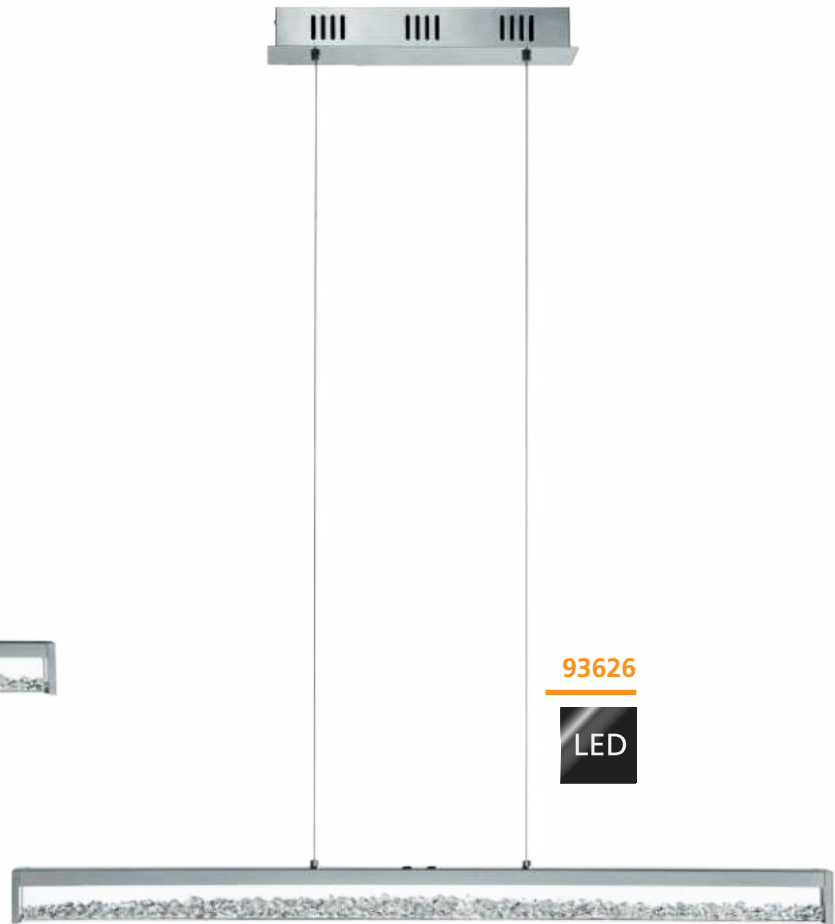

93626

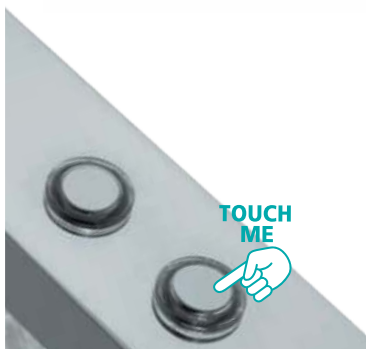

see the tunable white video
 unser Tunable White Video
 notre video de blanc réglable

CARDITO 1



Warm White 2700K Neutral White Cold White 5000K

These luminaires can be switched on and off by touching the specially designed "Touch Me" part of the fixture.

Features via touch-dimmer:

- > light colour adjustable between 2700K - 5000K
- > dimmable 10% - 100%

Diese Leuchten können ein und ausgeschaltet werden, indem man sie an den dafür vorgesehenen "Touch Me" Bereichen berührt. Per Touch-Dimmer verfügen diese Leuchten über folgende Funktionen:

- > Lichtfarbe einstellbar im Bereich 2700K bis 5000K
- > dimmbar 10% bis 100%

Ces luminaires peuvent être éteints et allumés simplement en touchant la partie spécialement conçue pour "Touch Me" du luminaire. Fonctions du gradateur "touch":

- > couleur lumineuse réglable de 2700K - 5000K
- > réglable en luminosité 10% - 100%

93625 CARDITO 1

pendant light; aluminium, steel, chrome / glass, brilliant glass, clear

Hängeleuchte; Alu, Stahl, chrom / Glas, Brillantglas, klar

luminaire en suspension; aluminium, acier, chrome / verre, verre brillant, transparent

L 700, B 80, H 750 - 1300



4x 6W



2280lm



9 002759 936259

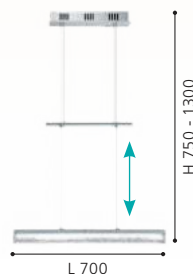

93626 CARDITO 1

pendant light; aluminium, steel, chrome / glass, brilliant glass, clear

Hängeleuchte; Alu, Stahl, chrom / Glas, Brillantglas, klar

luminaire en suspension; aluminium, acier, chrome / verre, verre brillant, transparent

L 1000, B 80, H 1100



6x 6W



3420lm



9 002759 936266

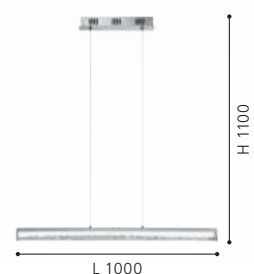



93092



31667

LED



93092 FEDRA 2

pendant light; steel, chrome / film, brilliant glass, mother-of-pearl, clear
 Hängeleuchte; Stahl, chrom / Folie, Brillantglas, perlmutt, klar
 luminaire en suspension; acier, chrome / film, verre brillant, nacré, transparent

H 1100, Ø 250



9 002759 930929



31667 VARRAZO

pendant light; steel, chrome / brilliant glass, clear
 Hängeleuchte; Stahl, chrom / Brillantglas, klar
 luminaire en suspension; acier, chrome / verre brillant, transparent

H 1200, Ø 550



9 002759 316679

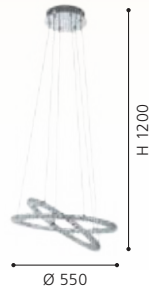

93092

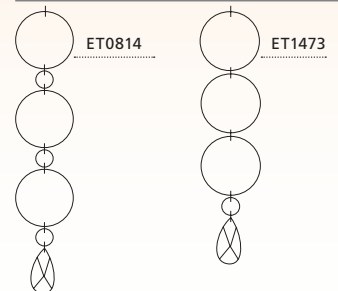

MONTEFIO 1

These lights are made with high quality brilliant glass.

Diese Leuchten sind mit hochwertigen Brilliant Glas ausgestattet.

Ces lumières sont fabriquées avec une haute qualité Equipé de verre brillant.



93073



93709

LED

93073 LUBERIO

pendant light; steel, chrome / glass, aluminium, clear, aluminium
Hängeleuchte; Stahl, chrom / Glas, Alu, klar, alu
luminaire en suspension; acier, chrome / verre, aluminium, transparent, aluminium

H 1100, Ø 250



E27



1x 60W



9 002759 930738



93709 MONTEFIO 1

pendant light; steel, chrome / glass, brilliant glass, white, clear
Hängeleuchte; Stahl, chrom / Glas, Brillantglas, weiss, klar
luminaire en suspension; acier, chrome / verre, verre brillant, blanc, transparent

H 1100, Ø 400



3x 5W



warm WHITE
1500lm



9 002759 937096

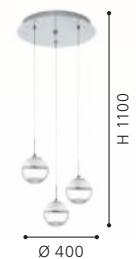



93708

LED



93784

LED

93708 MONTEFIO 1

pendant light; steel, chrome / glass, brilliant glass, white, clear
 Hängeleuchte; Stahl, chrom / Glas, Brillantglas, weiss, klar
 luminaire en suspension; acier, chrome / verre, verre brillant, blanc, transparent

H 1100, Ø 140



1x 5W 480lm



9 002759 937089



93784 MONTEFIO 1

pendant light; steel, chrome / glass, brilliant glass, white, clear
 Hängeleuchte; Stahl, chrom / Glas, Brillantglas, weiss, klar
 luminaire en suspension; acier, chrome / verre, verre brillant, blanc, transparent

L 870, B 140, H 1100



3x 5W 1440lm



9 002759 937843



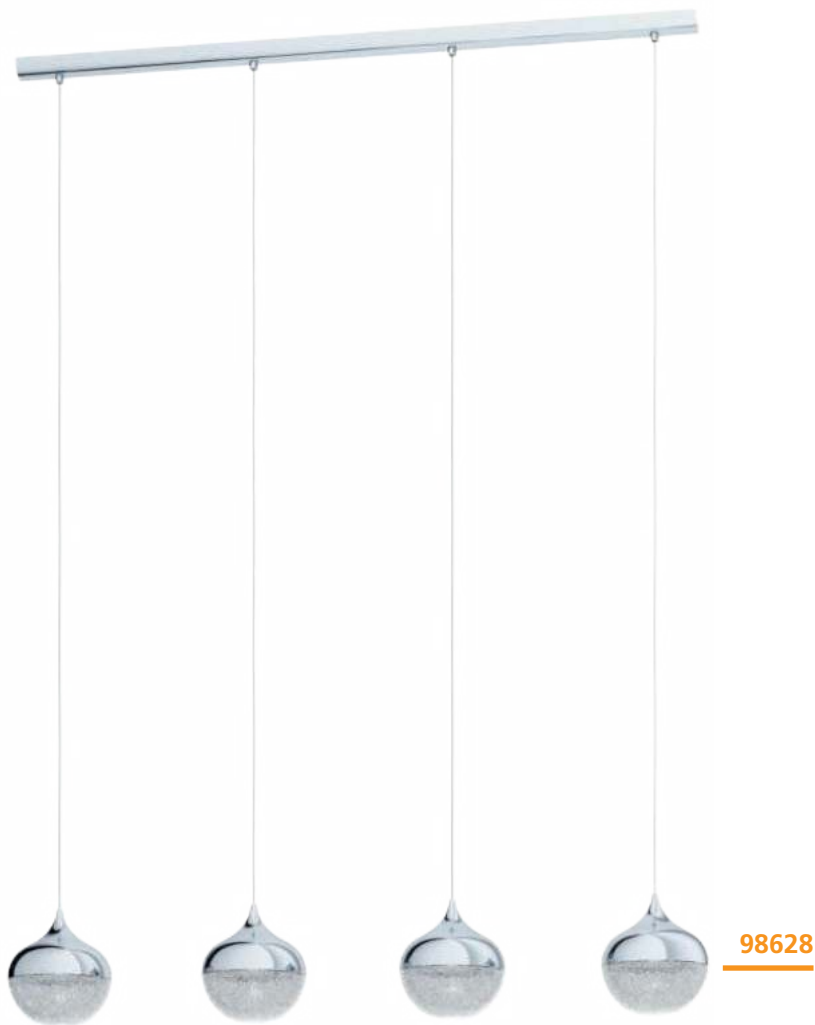

98628 MIOGLIA 1

pendant light; steel, chrome / plastic, granille white, clear
 Hängeleuchte; Stahl, chrom / Kunststoff, granille weiss, klar
 luminaire en suspension; acier, chrome / plastique, blanc granille, transparent

L 975, B 150, H 1100

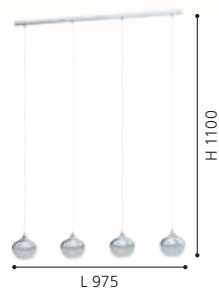

98629 MIOGLIA 1

pendant light; steel, chrome / plastic, granille white, clear
 Hängeleuchte; Stahl, chrom / Kunststoff, granille weiss, klar
 luminaire en suspension; acier, chrome / plastique, blanc granille, transparent

H 1500, Ø 540



95913 CONESSA

pendant light; steel, chrome / plastic, clear
 Hängeleuchte; Stahl, chrom / Kunststoff, klar
 luminaire en suspension; acier, chrome / plastique, transparent

H 1100, Ø 290

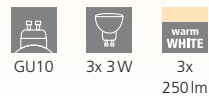



95912

LED

95913

LED





95914

LED

95912 CONESSA

pendant light; steel, chrome / plastic, clear
 Hängeleuchte; Stahl, chrom / Kunststoff, klar
 luminaire en suspension; acier, chrome / plastique, transparent

L 1010, B 150, H 1100

-  GU10
-  4x 3W
-  warm WHITE
4x 250lm





9 002759 959128



95914 CONESSA

pendant light; steel, chrome / plastic, clear
 Hängeleuchte; Stahl, chrom / Kunststoff, klar
 luminaire en suspension; acier, chrome / plastique, transparent

H 1700, Ø 580

-  GU10
-  10x 3W
-  warm WHITE
10x 250lm



9 002759 959142

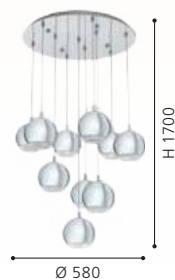



98678

LED

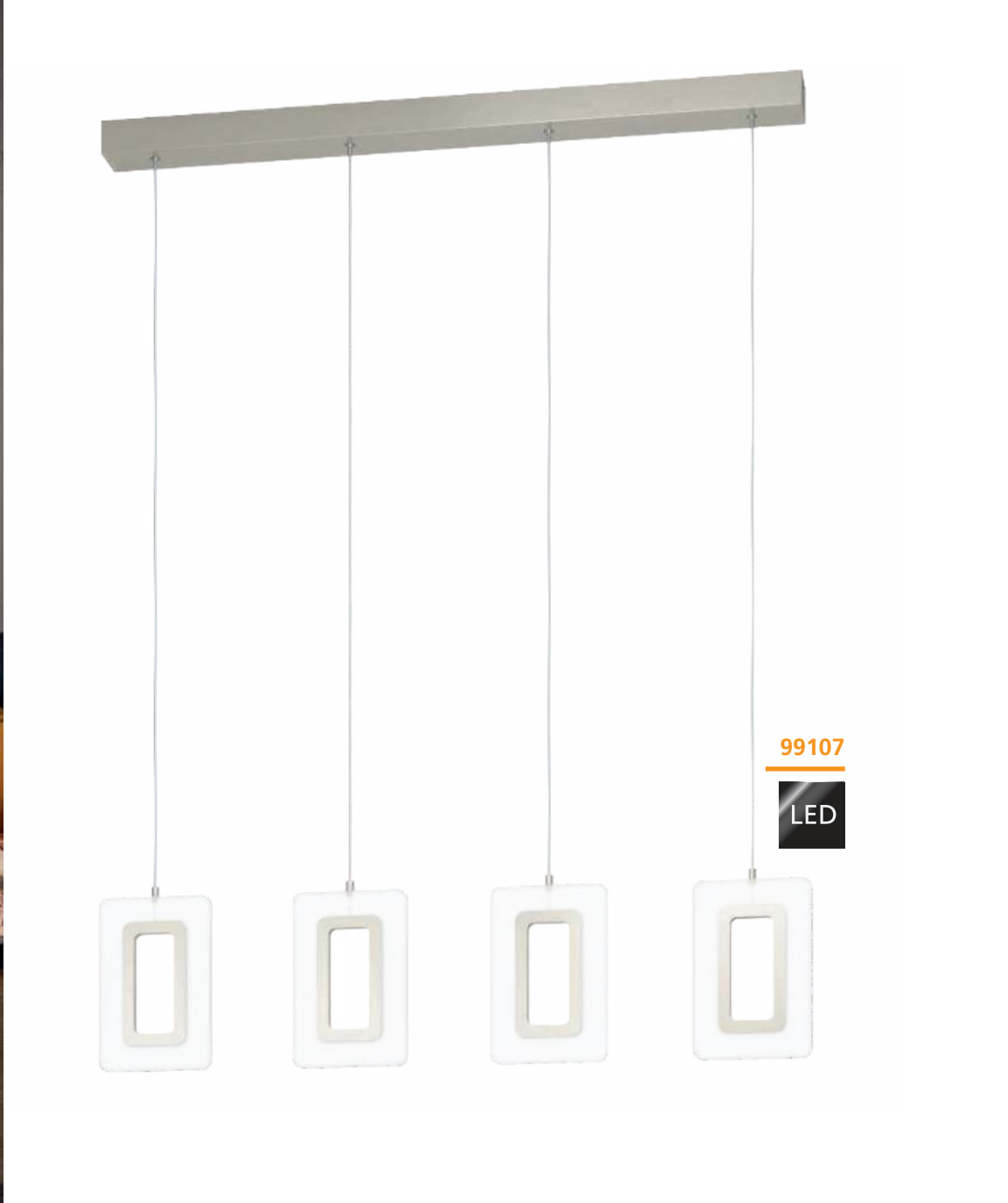

99107

LED

98678 ENALURI

pendant light; steel, satin nickel / plastic, satined
 Hängeleuchte; Stahl, nickel-matt / Kunststoff, satiniert
 luminaire en suspension; acier, nickel mat / plastique, satiné

L 140, B 105, H 1100

LED

warm
WHITE



1x 5,4W 630lm



9 002759 986780



99107 ENALURI

pendant light; steel, satin nickel / plastic, satined
 Hängeleuchte; Stahl, nickel-matt / Kunststoff, satiniert
 luminaire en suspension; acier, nickel mat / plastique, satiné

L 880, B 60, H 1100

LED

warm
WHITE



4x 5,4W 2520lm



9 002759 991074

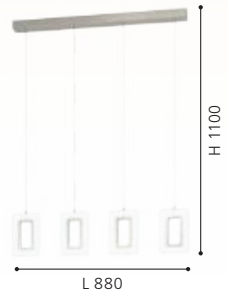

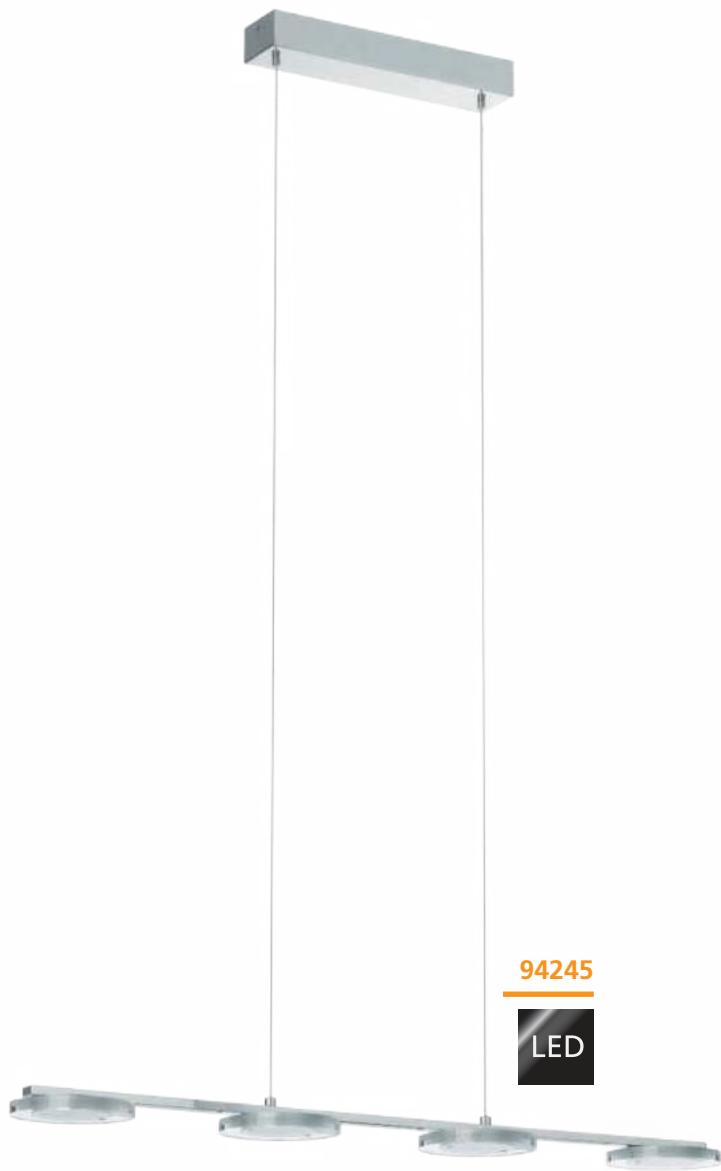

94245

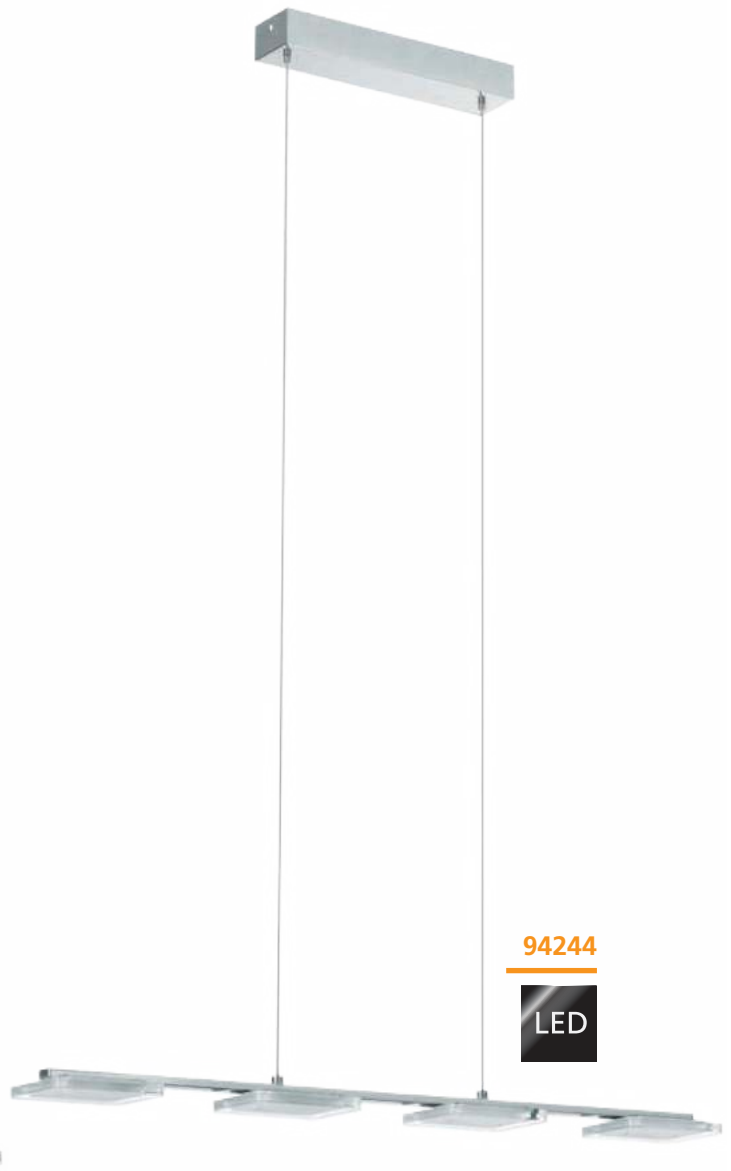

94244



94245 CARTAMA

pendant light; steel, chrome / plastic, clear, satined
 Hängeleuchte; Stahl, chrom / Kunststoff, klar, satiniert
 luminaire en suspension; acier, chrome / plastique, transparent, satiné

L 775, B 115, H 1100



4x 4,6W 2200lm



9 002759 942458

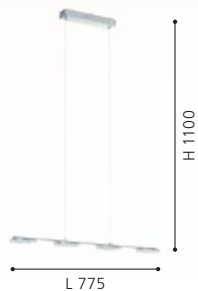

94244 CARTAMA

pendant light; steel, chrome / plastic, clear, satined
 Hängeleuchte; Stahl, chrom / Kunststoff, klar, satiniert
 luminaire en suspension; acier, chrome / plastique, transparent, satiné

L 780, B 90, H 1100



4x 4,6W 2200lm



9 002759 942441

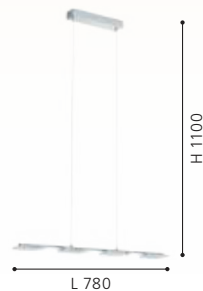



97366

97367

97366 MONTEFINO

pendant light; steel, black / glass, clear
 Hängeleuchte; Stahl, schwarz / Glas, klar
 luminaire en suspension; acier, noir / verre, transparent

H 1100, Ø 110



9 002759 973667



97367 MONTEFINO

pendant light; steel, black / glass, clear
 Hängeleuchte; Stahl, schwarz / Glas, klar
 luminaire en suspension; acier, noir / verre, transparent

L 730, B 110, H 1100



9 002759 973674



97368 MONTEFINO

pendant light; steel, black / glass, clear
 Hängeleuchte; Stahl, schwarz / Glas, klar
 luminaire en suspension; acier, noir / verre, transparent

H 1500, Ø 350



9 002759 973681





97368



98056



98058

98056 CORTENOVA

pendant light; steel, black
Hängeleuchte; Stahl, schwarz
luminaire en suspension; acier, noir

H 1100, Ø 105



E27



1x 60W



9 002759 980566

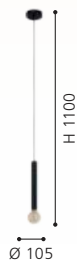

98058 CORTENOVA

pendant light; steel, black
Hängeleuchte; Stahl, schwarz
luminaire en suspension; acier, noir

H 1500, Ø 350



E27



5x 60W



9 002759 980580



98057 CORTENOVA

pendant light; steel, black
Hängeleuchte; Stahl, schwarz
luminaire en suspension; acier, noir

L 840, B 60, H 1100



E27



4x 60W



9 002759 980573





98057



98661





POZUETA



98663



98662

98661 POZUETA

pendant light; steel, black
Hängeleuchte; Stahl, schwarz
luminaire en suspension; acier, noir

H 1100, Ø 125



E27 1x 40W



9 002759 986612



98663 POZUETA

pendant light; steel, black
Hängeleuchte; Stahl, schwarz
luminaire en suspension; acier, noir

H 1500, Ø 330



E27 3x 40W



9 002759 986636



98662 POZUETA

pendant light; steel, black
Hängeleuchte; Stahl, schwarz
luminaire en suspension; acier, noir

L 840, B 65, H 1100



E27 3x 40W



9 002759 986629





98346



98347

98346 BOCADELLA

pendant light; steel, black
 Hängeleuchte; Stahl, schwarz
 luminaire en suspension; acier, noir

H 1100, Ø 640



E27



9x 60W



9 002759 983468

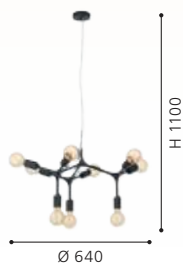

98347 BOCADELLA

pendant light; steel, black
 Hängeleuchte; Stahl, schwarz
 luminaire en suspension; acier, noir

H 1100, Ø 920



E27



12x 60W



9 002759 983475

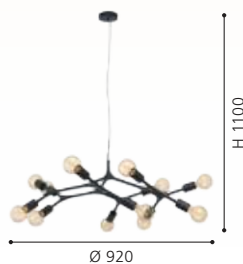

98909 MEZZANA

pendant light; steel, black
 Hängeleuchte; Stahl, schwarz
 luminaire en suspension; acier, noir

L 650, B 650, H 1100



E27



8x 40W



9 002759 989095

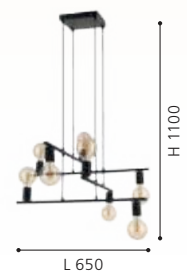



98909



98017



98016



99811

GRADOLI & GRADOLI 1

The arms of the luminaire can be swiveled individually.

Die Leuchtenarme sind individuell schwenkbar.

Les bras du luminaire peuvent être pivotés individuellement.

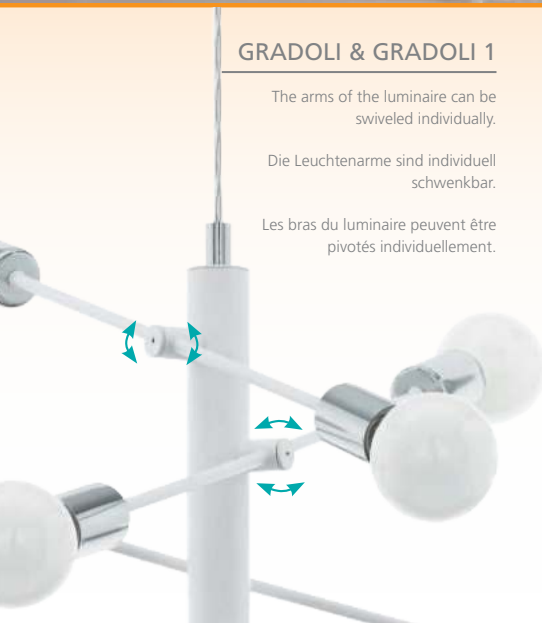

98017 GRADOLI

pendant light; steel, white, chrome
Hängeleuchte; Stahl, weiss, chrom
luminaire en suspension; acier, blanc, chrome

H 1100, Ø 710



9 002759 980177

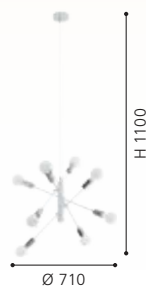

98016 GRADOLI

pendant light; steel, white, chrome
Hängeleuchte; Stahl, weiss, chrom
luminaire en suspension; acier, blanc, chrome

H 1100, Ø 550

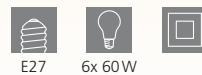

9 002759 980160





98835



MANIZALES



98834

99811 GRADOLI 1

pendant light; steel, brushed brass
Hängeleuchte; Stahl, messing-gebürstet
luminaire en suspension; acier, laiton brossé

H 1100, Ø 710

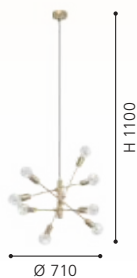

98835 MANIZALES

pendant light; steel, brushed brass
Hängeleuchte; Stahl, messing-gebürstet
luminaire en suspension; acier, laiton brossé

L 1010, B 50, H 1100



98834 MANIZALES

pendant light; steel, brushed brass
Hängeleuchte; Stahl, messing-gebürstet
luminaire en suspension; acier, laiton brossé

L 250, B 105, H 1100

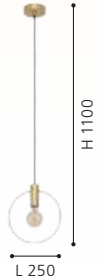



900399



97733

LED

900399 CUMIOLE

pendant light; steel, gold-coloured
 Hängeleuchte; Stahl, goldfarben
 luminaire en suspension; acier, or

L 780, B 150, H 1100



E27



3x 40W



9 008606 243754

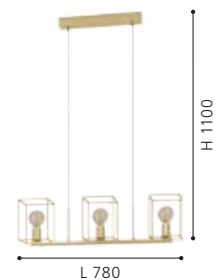



97733 MONTEBALDO

pendant light; steel, black, gold
 Hängeleuchte; Stahl, schwarz, gold
 luminaire en suspension; acier, noir, or

L 100, B 100, H 1100

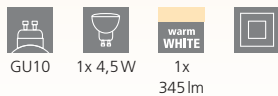

GU10 1x 4,5W
 warm WHITE 1x 345lm



9 002759 977337



97734 MONTEBALDO

pendant light; steel, black, gold
 Hängeleuchte; Stahl, schwarz, gold
 luminaire en suspension; acier, noir, or

L 850, B 100, H 1100



GU10 4x 4,5W
 warm WHITE 4x 345lm



9 002759 977344



98858 BITACHITO

pendant light; steel, black, brass
 Hängeleuchte; Stahl, schwarz, messing
 luminaire en suspension; acier, noir, laiton

L 930, B 55, H 1100



E27 4x 40W



9 002759 988586

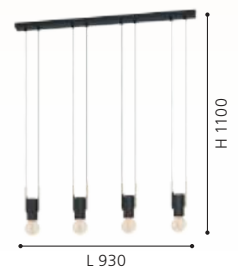



97604 CORTADERAS

pendant light; steel, black, gold
 Hängeleuchte; Stahl, schwarz, gold
 luminaire en suspension; acier, noir, or

H 1500, Ø 95



97605 CORTADERAS

pendant light; steel, black, gold
 Hängeleuchte; Stahl, schwarz, gold
 luminaire en suspension; acier, noir, or

L 1130, B 85, H 1500

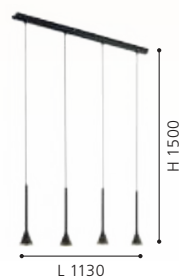
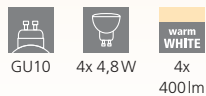

97606 CORTADERAS

pendant light; steel, black, gold
 Hängeleuchte; Stahl, schwarz, gold
 luminaire en suspension; acier, noir, or

H 1500, Ø 350

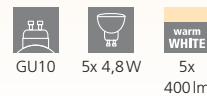



97606

LED



900401

LED



900402

LED

900401 SARONA

pendant light; steel, black, gold
Hängeleuchte; Stahl, schwarz, gold
luminaire en suspension; acier, noir, or

H 1100, Ø 210



GU10



1x 4,5W



1x

345lm



9 008606 243761



900402 SARONA

pendant light; steel, black, gold
Hängeleuchte; Stahl, schwarz, gold
luminaire en suspension; acier, noir, or

L 910, B 50, H 1100



GU10



3x 4,5W



3x

345lm

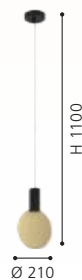

Ø 210



9 008606 243778



L 910

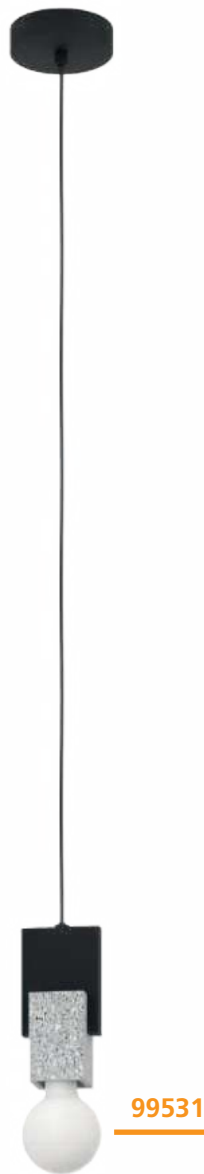

99531



99532

99531 LOBATIA

pendant light; steel, wood, black / terrazzo, grey, white
 Hängeleuchte; Stahl, Holz, schwarz / Terrazzo, grau, weiss
 luminaire en suspension; acier, bois, noir / terrazzo, gris, blanc

H 1100, Ø 105



99532 LOBATIA

pendant light; steel, wood, black / terrazzo, grey, white
 Hängeleuchte; Stahl, Holz, schwarz / Terrazzo, grau, weiss
 luminaire en suspension; acier, bois, noir / terrazzo, gris, blanc

L 925, B 55, H 1100



LOBATIA



95522



95523

95522 SILVARES

pendant light; steel, grey / concrete, grey
Hängeleuchte; Stahl, grau / Beton, grau
luminaire en suspension; acier, gris / béton, gris

H 1100, Ø 110



95523 SILVARES

pendant light; steel, grey / concrete, grey
Hängeleuchte; Stahl, grau / Beton, grau
luminaire en suspension; acier, gris / béton, gris

H 1500, Ø 250





95525



95526

95525 TAREGA

pendant light; steel, grey / wood, concrete, brown, grey
 Hängeleuchte; Stahl, grau / Holz, Beton, braun, grau
 luminaire en suspension; acier, gris / bois, béton, marron, gris

H 1100, Ø 150



E27 1x 40W



9 002759 955250

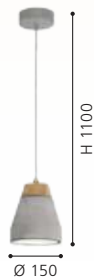

95526 TAREGA

pendant light; steel, grey / wood, concrete, brown, grey
 Hängeleuchte; Stahl, grau / Holz, Beton, braun, grau
 luminaire en suspension; acier, gris / bois, béton, marron, gris

H 1500, Ø 250



E27 3x 40W



9 002759 955267





99464

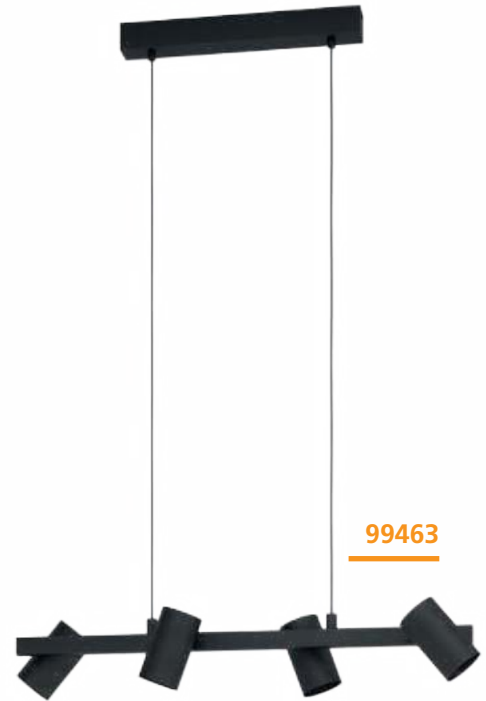

99463



GATUELA, GATUELA 1

The lamp heads can be swiveled.

Die Leuchtenköpfe sind schwenkbar.

Les têtes de lampe peuvent être pivotées.

99464 GATUELA 1

pendant light; steel, black
Hängeleuchte; Stahl, schwarz
luminaire en suspension; acier, noir

L 1160, B 190, H 1100



E14



6x 25W



9 002759 994648

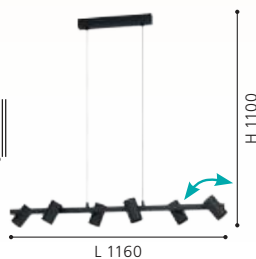

99463 GATUELA 1

pendant light; steel, black
Hängeleuchte; Stahl, schwarz
luminaire en suspension; acier, noir

L 760, B 190, H 1100



E14



4x 25W



9 002759 994631





98687 GATUELA

pendant light; steel, white, satin nickel
 Hängeleuchte; Stahl, weiss, nickel-matt
 luminaire en suspension; acier, blanc, nickel mat

L 1160, B 190, H 1100

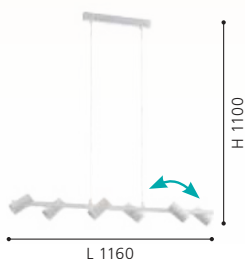

99819 ROVIRA

pendant light; aluminium, steel, silver / plastic, white
 Hängeleuchte; Alu, Stahl, silber / Kunststoff, weiss
 luminaire en suspension; aluminium, acier, argent / plastique, blanc

L 770, B 50, H 1100

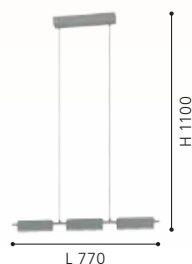

99821 ROVIRA

pendant light; aluminium, steel, black / plastic, white
 Hängeleuchte; Alu, Stahl, schwarz / Kunststoff, weiss
 luminaire en suspension; aluminium, acier, noir / plastique, blanc

L 770, B 50, H 1100

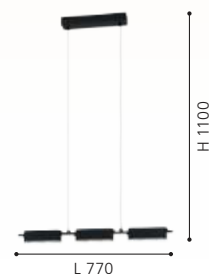

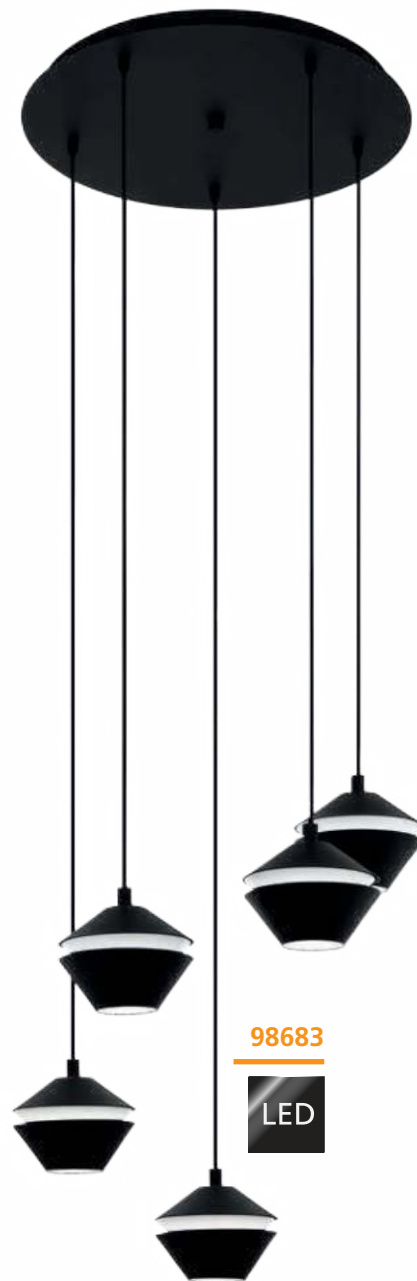

98682 PERPIGO

pendant light; steel, black / plastic, white
 Hängeleuchte; Stahl, schwarz / Kunststoff, weiss
 luminaire en suspension; acier, noir / plastique, blanc

L 865, B 165, H 1100

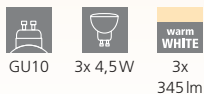

9 002759 986827

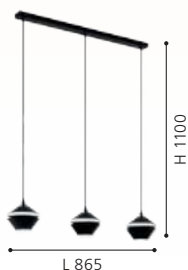

98683 PERPIGO

pendant light; steel, black / plastic, white
 Hängeleuchte; Stahl, schwarz / Kunststoff, weiss
 luminaire en suspension; acier, noir / plastique, blanc

H 1500, Ø 555



9 002759 986834



99013 PALBIETA

pendant light; steel, black / plastic, clear, satiné
 Hängeleuchte; Stahl, schwarz / Kunststoff, klar, satiniert
 luminaire en suspension; acier, noir / plastique, transparent, satiné

L 1160, B 115, H 1100



9 002759 990138

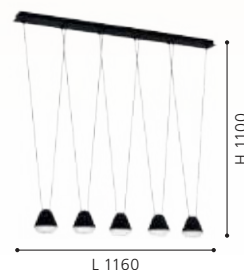



99013

LED



98492 AMONTILLADO

pendant light; aluminium, steel, black / plastic, white
 Hängeleuchte; Alu, Stahl, schwarz / Kunststoff, weiss
 luminaire en suspension; aluminium, acier, noir / plastique, blanc

L 1160, B 85, H 1100



2x 13,5W 3500lm



9 002759 984922

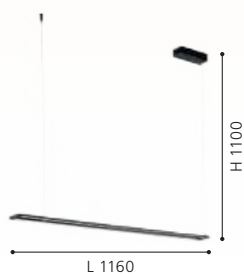

99599 CAMBULOS

pendant light; steel, black / plastic, white
 Hängeleuchte; Stahl, schwarz / Kunststoff, weiss
 luminaire en suspension; acier, noir / plastique, blanc

L 935, B 105, H 1100



2x 17W 4300lm



9 002759 995997



98495 SPADAFORA

pendant light; aluminium, steel, black / plastic, clear, white
 Hängeleuchte; Alu, Stahl, schwarz / Kunststoff, klar, weiss
 luminaire en suspension; aluminium, acier, noir / plastique, transparent, blanc

L 1160, B 80, H 1100



2x 7,5W 2000lm



9 002759 984953





98836



98836 ERMUA

pendant light; steel, wood, black, brown / plastic, white
 Hängeleuchte; Stahl, Holz, schwarz, braun / Kunststoff, weiss
 luminaire en suspension; acier, bois, noir, marron / plastique, blanc

L 1000, B 165, H 1100



27W 3850lm



9 002759 988364

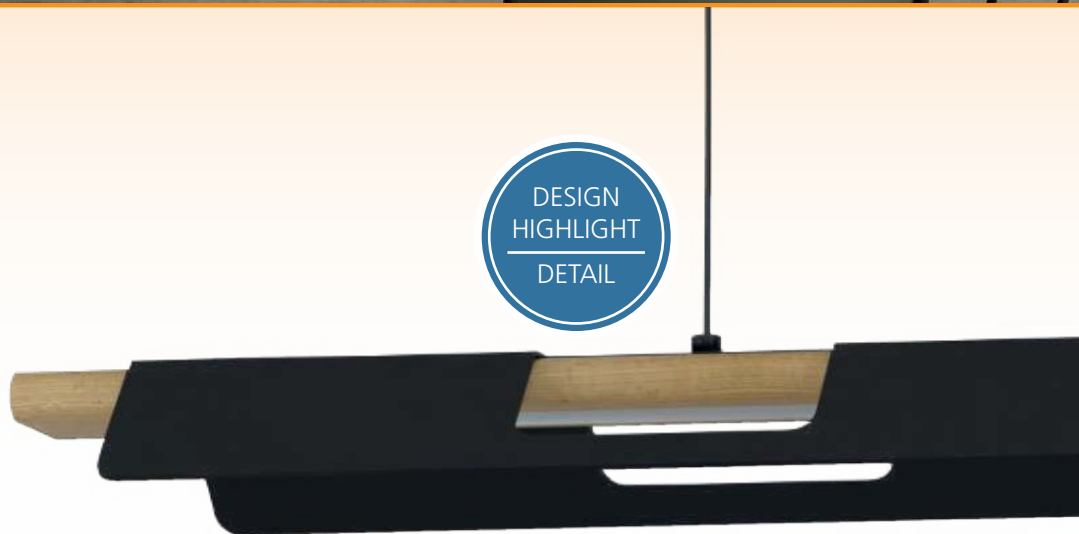



900175

LED



DESIGN
HIGHLIGHT
DETAIL



900174

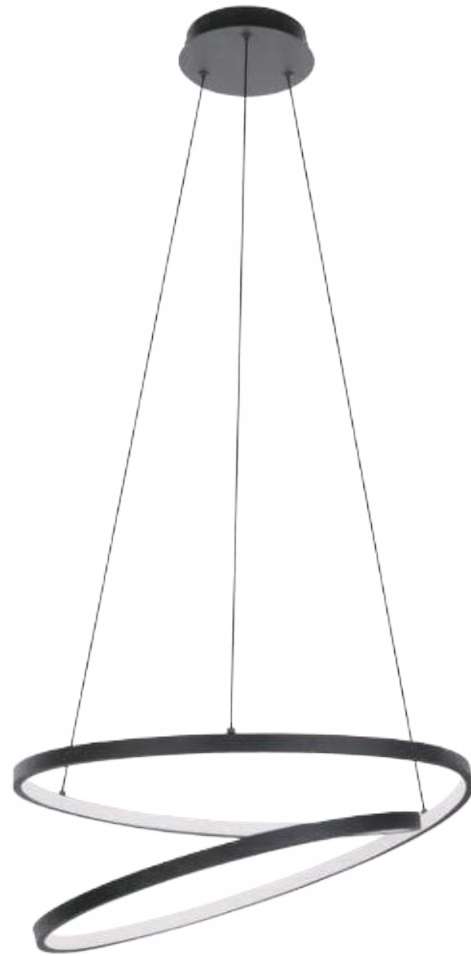

900472



900175 LISCIANA

pendant light; aluminium, steel, wood, grey / plastic, white
Hängeleuchte; Alu, Stahl, Holz, grau / Kunststoff, weiss
luminaire en suspension; aluminium, acier, bois, gris / plastique, blanc

L 1260, B 35, H 1100



22W 2500lm



9 008606 238088

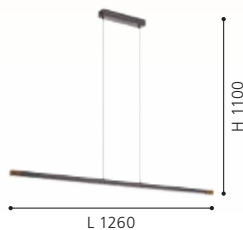

900174 LISCIANA

pendant light; aluminium, steel, wood, grey / plastic, white
Hängeleuchte; Alu, Stahl, Holz, grau / Kunststoff, weiss
luminaire en suspension; aluminium, acier, bois, gris / plastique, blanc

L 875, B 35, H 1100



18W 2000lm



9 008606 238071

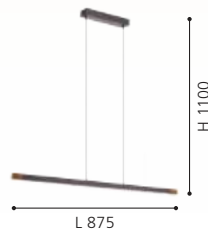

900472 RUOTALE

pendant light; aluminium, steel, black / plastic, white
Hängeleuchte; Alu, Stahl, schwarz / Kunststoff, weiss
luminaire en suspension; aluminium, acier, noir / plastique, blanc

H 1500, Ø 550



37W 4800lm



9 008606 239931

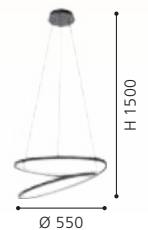



99818

LED



99249

LED

99818 SALITRE

pendant light; aluminium, black / plastic, white
 Hängeleuchte; Alu, schwarz / Kunststoff, weiss
 luminaire en suspension; aluminium, noir / plastique, blanc

H 1200, Ø 730

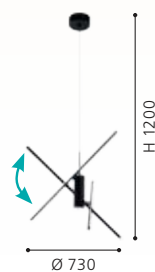

99249 CORREDERA

pendant light; steel, black / plastic, white
 Hängeleuchte; Stahl, schwarz / Kunststoff, weiss
 luminaire en suspension; acier, noir / plastique, blanc

H 1200, Ø 500



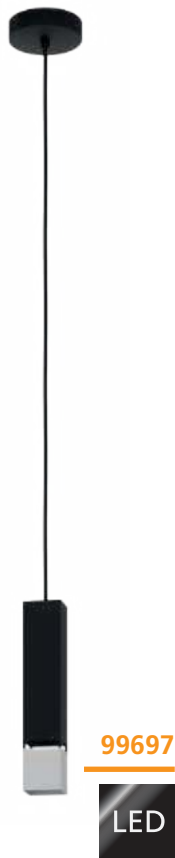

99697

LED



99698

LED

99697 BUTRANO

pendant light; steel, black, silver
 Hängeleuchte; Stahl, schwarz, silber
 luminaire en suspension; acier, noir, argent

L 55, B 55, H 1100

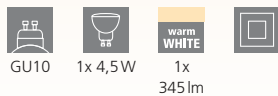

GU10 1x 4,5W 1x 345lm



99698 BUTRANO

pendant light; steel, black, silver
 Hängeleuchte; Stahl, schwarz, silber
 luminaire en suspension; acier, noir, argent

L 770, B 55, H 1100

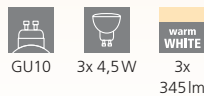

GU10 3x 4,5W 3x 345lm





99073



99072



DESIGN
HIGHLIGHT
DETAIL

99073 MIRTAZZA

pendant light; steel, black / steel, champagne
Hängeleuchte; Stahl, schwarz / Stahl, champagner
luminaire en suspension; acier, noir / acier, champagne

H 1100, Ø 590



9 002759 990732



99072 MIRTAZZA

pendant light; steel, black / steel, champagne
Hängeleuchte; Stahl, schwarz / Stahl, champagner
luminaire en suspension; acier, noir / acier, champagne

L 880, B 180, H 1100



9 002759 990725





98688

98689

97066

98688 OKINZURI

pendant light; steel, nickel-nero
 Hängeleuchte; Stahl, nickel-nero
 luminaire en suspension; acier, nickel noir

H 1100, Ø 450



E27 1x 60W



9 002759 986889



98689 OKINZURI

pendant light; steel, brass
 Hängeleuchte; Stahl, messing
 luminaire en suspension; acier, laiton

H 1100, Ø 450



E27 1x 60W



9 002759 986896



97066 ESTEVAU

pendant light; steel, dark brown
 Hängeleuchte; Stahl, dunkelbraun
 luminaire en suspension; acier, marron foncé

L 975, B 145, H 1100



E27 4x 60W



9 002759 970666





92251

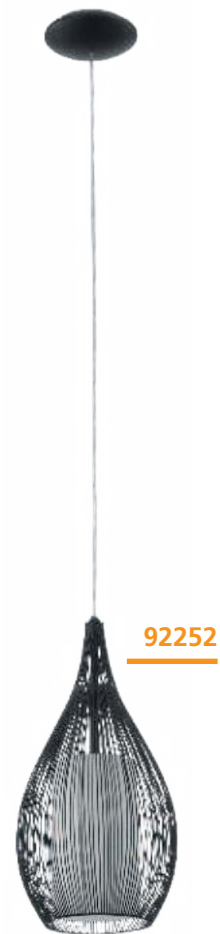

92252



RAZONI

92251 RAZONI

pendant light; steel, white / satin glass, steel, white
Hängeleuchte; Stahl, weiss / Glas satiniert, Stahl, weiss
luminaire en suspension; acier, blanc / verre satiné, acier, blanc

H 1300, Ø 190



E27



1x 60W



9 002759 922511





94388



94389

92252 RAZONI

pendant light; steel, black / satin glass, steel, black, white
 Hängeleuchte; Stahl, schwarz / Glas satiniert, Stahl, schwarz, weiss
 luminaire en suspension; acier, noir / verre satiné, acier, noir, blanc

H 1300, Ø 190



E27 1x 60W



9 002759 922528



94388 RAZONI

pendant light; steel, white / satin glass, steel, white
 Hängeleuchte; Stahl, weiss / Glas satiniert, Stahl, weiss
 luminaire en suspension; acier, blanc / verre satiné, acier, blanc

L 990, B 190, H 1100



E27 3x 60W



9 002759 943882

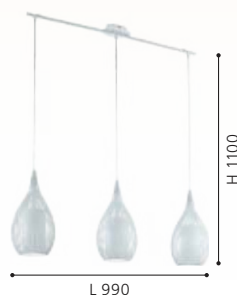

94389 RAZONI

pendant light; steel, black / satin glass, steel, black, white
 Hängeleuchte; Stahl, schwarz / Glas satiniert, Stahl, schwarz, weiss
 luminaire en suspension; acier, noir / verre satiné, acier, noir, blanc

L 990, B 190, H 1100



E27 3x 60W



9 002759 943899





DESIGN
HIGHLIGHT
DETAIL



99635 | 99636

99634

99636

99634 MASETA

pendant light; steel, black / smoked glass, black-transparent
Hängeleuchte; Stahl, schwarz / Rauchglas, schwarz-transparent
luminaire en suspension; acier, noir / verre fumé, noir transparent

L 930, B 225, H 1100



99636 MASETA

pendant light; steel, gold-coloured / glass opal-matt, white
Hängeleuchte; Stahl, goldfarben / Glas opal-matt, weiss
luminaire en suspension; acier, or / verre opale mat, blanc

L 930, B 225, H 1100



99635 MASETA

pendant light; steel, gold-coloured / glass opal-matt, white
Hängeleuchte; Stahl, goldfarben / Glas opal-matt, weiss
luminaire en suspension; acier, or / verre opale mat, blanc

H 1100, Ø 225



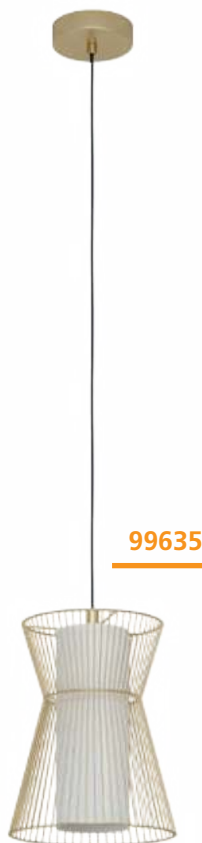

99633 | 99634

99633 MASETA

pendant light; steel, black / smoked glass, black-transparent
Hängeleuchte; Stahl, schwarz / Rauchglas, schwarz-transparent
luminaire en suspension; acier, noir / verre fumé, noir transparent

H 1100, Ø 225



E27



1x 40W

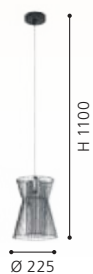



99705 FLORESTA

pendant light; steel, black / glass vaporized, black-transparent
 Hängeleuchte; Stahl, schwarz / Glas bedampft, schwarz-transparent
 luminaire en suspension; acier, noir / verre vaporisé, noir transparent

H 1100, Ø 195



99706 FLORESTA

pendant light; steel, black / glass vaporized, black-transparent
 Hängeleuchte; Stahl, schwarz / Glas bedampft, schwarz-transparent
 luminaire en suspension; acier, noir / verre vaporisé, noir transparent

L 890, B 190, H 1100



99707 ZOCABON

pendant light; steel, black / glass, clear
 Hängeleuchte; Stahl, schwarz / Glas, klar
 luminaire en suspension; acier, noir / verre, transparent

L 815, B 110, H 1100

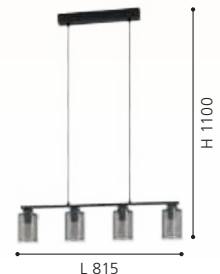



99619



99618

99619 MULEGES

pendant light; steel, black / glass opal-matt, white
 Hängeleuchte; Stahl, schwarz / Glas opal-matt, weiss
 luminaire en suspension; acier, noir / verre opale mat, blanc

L 960, B 160, H 1100



9 002759 996192

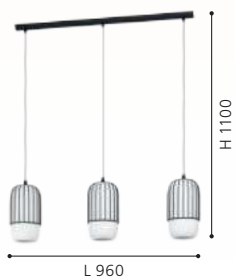

99618 MULEGES

pendant light; steel, black / glass opal-matt, white
 Hängeleuchte; Stahl, schwarz / Glas opal-matt, weiss
 luminaire en suspension; acier, noir / verre opale mat, blanc

H 1100, Ø 160



9 002759 996185

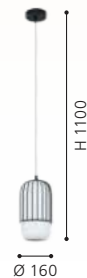



99661



99662

99661 CURASAO

pendant light; steel, black / steel, fabric, black, gold
 Hängeleuchte; Stahl, schwarz / Stahl, Textil, schwarz, gold
 luminaire en suspension; acier, noir / acier, tissu, noir, or

H 1100, Ø 335



99662 CURASAO

pendant light; steel, black / steel, fabric, black, gold
 Hängeleuchte; Stahl, schwarz / Stahl, Textil, schwarz, gold
 luminaire en suspension; acier, noir / acier, tissu, noir, or

L 995, B 235, H 1100



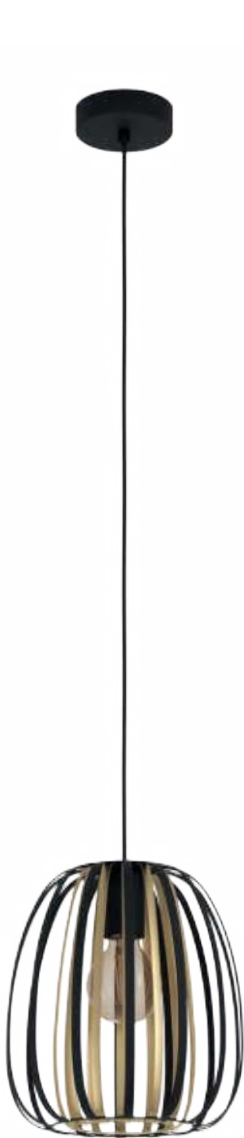

99665

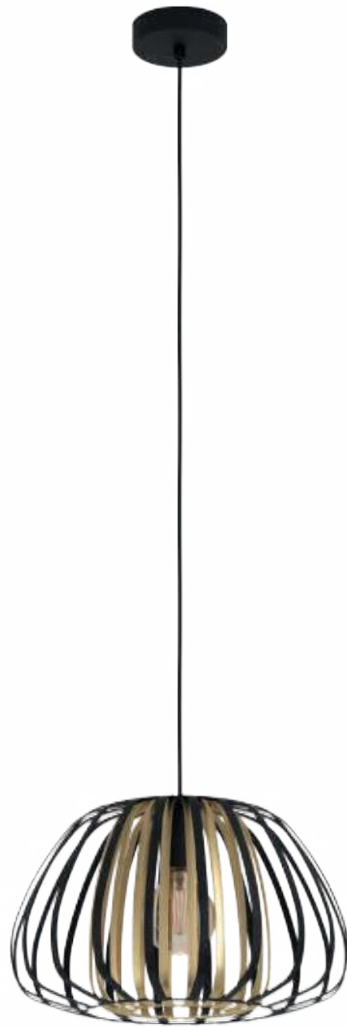

99666

DESIGN
HIGHLIGHT
DETAIL



99665 ENCINITOS

pendant light; steel, black, gold
Hängeleuchte; Stahl, schwarz, gold
luminaire en suspension; acier, noir, or

H 1100, Ø 255



E27 1x 40W



9 002759 996659



99666 ENCINITOS

pendant light; steel, black, gold
Hängeleuchte; Stahl, schwarz, gold
luminaire en suspension; acier, noir, or

H 1100, Ø 375



E27 1x 40W



9 002759 996666





99694



99693

99693

99694 CALMANERA

pendant light; steel, black, brass
 Hängeleuchte; Stahl, schwarz, messing
 luminaire en suspension; acier, noir, laiton

L 900, B 200, H 1100



9 002759 996949



99693 CALMANERA

pendant light; steel, black, brass
 Hängeleuchte; Stahl, schwarz, messing
 luminaire en suspension; acier, noir, laiton

H 1100, Ø 325



9 002759 996932

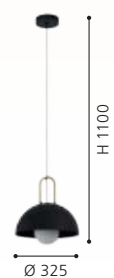



99695 | 99696

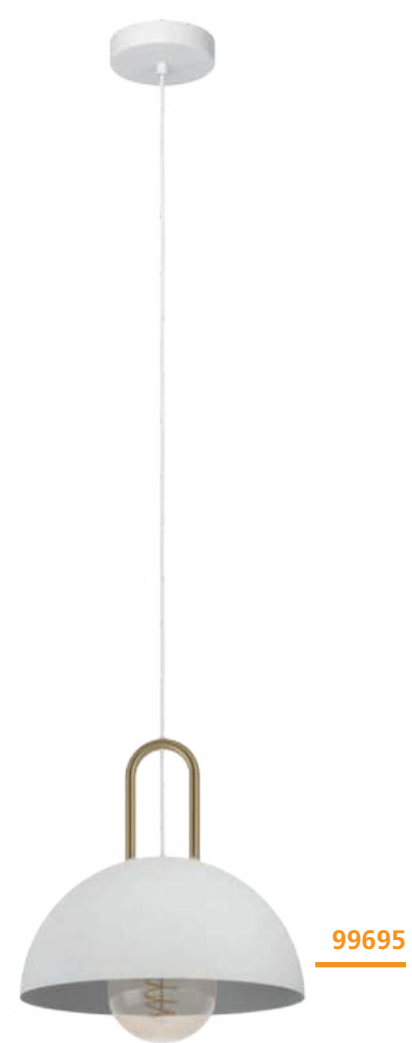

99696 CALMANERA

pendant light; steel, white, brass
 Hängeleuchte; Stahl, weiss, messing
 luminaire en suspension; acier, blanc, laiton

L 900, B 200, H 1100

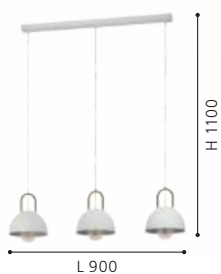

99695 CALMANERA

pendant light; steel, white, brass
 Hängeleuchte; Stahl, weiss, messing
 luminaire en suspension; acier, blanc, laiton

H 1100, Ø 325

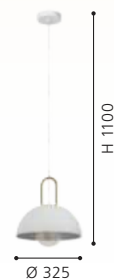



900429



900431

900429 VALDIOLA

pendant light; steel, sandy, brushed brass
 Hängeleuchte; Stahl, sandfarben, messing-gebürstet
 luminaire en suspension; acier, couleur sable, laiton brossé

H 1100, Ø 360



9 008606 240562

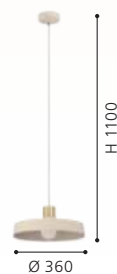

900431 VALDIOLA

pendant light; steel, sandy, brushed brass
 Hängeleuchte; Stahl, sandfarben, messing-gebürstet
 luminaire en suspension; acier, couleur sable, laiton brossé

L 930, B 230, H 1100



9 008606 240579

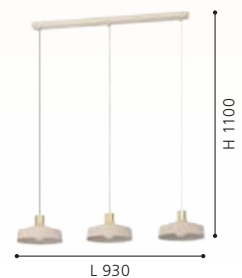



98839

LED



98838

LED

98839 LOSALOMAS

pendant light; steel, Mokka colour, brushed brass
 Hängeleuchte; Stahl, Mokkafarben, messing-gebürstet
 luminaire en suspension; acier, café, laiton brossé

L 835, B 135, H 1100

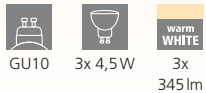

98838 LOSALOMAS

pendant light; steel, Mokka colour, brushed brass
 Hängeleuchte; Stahl, Mokkafarben, messing-gebürstet
 luminaire en suspension; acier, café, laiton brossé

H 1100, Ø 135

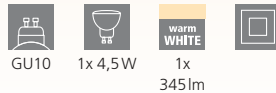

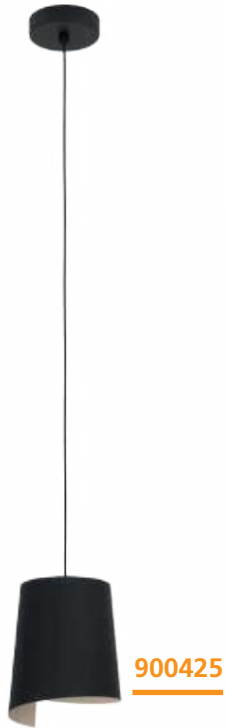

900425



900426



900143

900425 BOLIVIA

pendant light; steel, black / steel, black, sandy
 Hängeleuchte; Stahl, schwarz / Stahl, schwarz, sandfarben
 luminaire en suspension; acier, noir / acier, noir, couleur sable

H 1100, Ø 180



E27 1x 40W



9 008606 243853



900426 BOLIVIA

pendant light; steel, black / steel, black, sandy
 Hängeleuchte; Stahl, schwarz / Stahl, schwarz, sandfarben
 luminaire en suspension; acier, noir / acier, noir, couleur sable

L 880, B 180, H 1100



E27 3x 40W



9 008606 243860



900143 CAMBAITO

pendant light; steel, sandy
 Hängeleuchte; Stahl, sandfarben
 luminaire en suspension; acier, couleur sable

L 895, B 195, H 1100



E27 3x 40W



9 008606 238927

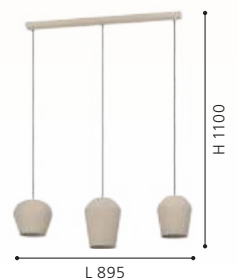



900158



900159

900158 CAMASCA

pendant light; steel, black
Hängeleuchte; Stahl, schwarz
luminaire en suspension; acier, noir

H 500 - 1100, Ø 280

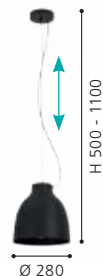

900159 CAMASCA

pendant light; steel, taupe
Hängeleuchte; Stahl, taupe
luminaire en suspension; acier, taupe

H 500 - 1100, Ø 280

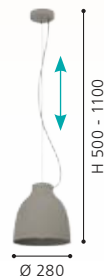

CAMASCA

These luminaires are height adjustable.
Diese Leuchten sind höhenverstellbar.
Ces luminaires sont réglables en hauteur.





900346



99438



900346 GAZZOLA

pendant light; steel, Mokka colour, sandy
 Hängeleuchte; Stahl, Mokka, Sandfarben
 luminaire en suspension; acier, café, couleur sable

L 910, B 150, H 1100



E27



5x 40W



9 008606 235889



99438 SEGEZIA

pendant light; steel, Mokka colour / steel, Mokka colour, gold
 Hängeleuchte; Stahl, Mokkafarben / Stahl, Mokka, gold
 luminaire en suspension; acier, café / acier, Mokka, or

L 880, B 180, H 1100



E27



3x 40W



9 002759 994389

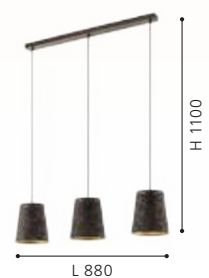



99439

99439 SEGEZIA

pendant light; steel, Mokka colour / steel, Mokka colour, gold
Hängeleuchte; Stahl, Mokkafarben / Stahl, Mokka, gold
luminaire en suspension; acier, café / acier, Mokka, or

H 1100, Ø 350



E27



1x 40W



9 002759 994396



DESIGN
HIGHLIGHT
DETAIL





98071

98071 CAMASTRA

pendant light; steel, black, gold
Hängeleuchte; Stahl, schwarz, gold
luminaire en suspension; acier, noir, or

H 1100, Ø 225



E27



1x 40W



9 002759 980719

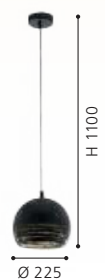



98353



98456

98353 RAMON

pendant light; steel, black / film, white
 Hängeleuchte; Stahl, schwarz / Folie, weiss
 luminaire en suspension; acier, noir / film, blanc

L 860, B 160, H 1100



9 002759 983536

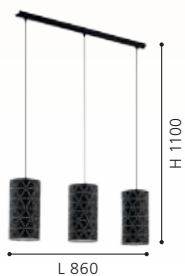

98456 CANTALLOPS

pendant light; steel, black, white
 Hängeleuchte; Stahl, schwarz, weiss
 luminaire en suspension; acier, noir, blanc

L 1150, B 520, H 1100



9 002759 984564

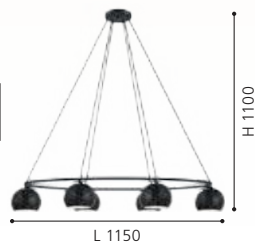

DESIGN
 HIGHLIGHT
 DETAIL



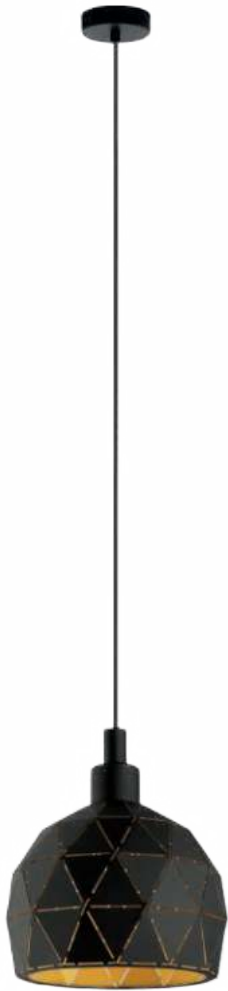

33345



97845



97841

33345 ROCCAFORTE

pendant light; steel, black, gold
Hängeleuchte; Stahl, schwarz, gold
luminaire en suspension; acier, noir, or

H 1100, Ø 170



E14 1x 40W



9 002759 333454

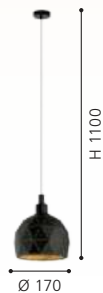

97845 ROCCAFORTE

pendant light; steel, black, gold
Hängeleuchte; Stahl, schwarz, gold
luminaire en suspension; acier, noir, or

H 1100, Ø 300



E27 1x 60W



9 002759 978457



97841 ROCCAFORTE

pendant light; steel, black, gold
Hängeleuchte; Stahl, schwarz, gold
luminaire en suspension; acier, noir, or

H 1100, Ø 400



E27 1x 60W



9 002759 978419





97846

97846 ROCCAFORTE

pendant light; steel, black, gold
Hängeleuchte; Stahl, schwarz, gold
luminaire en suspension; acier, noir, or

L 750, B 170, H 1100

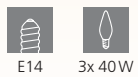

E14 3x 40W



9 002759 978464

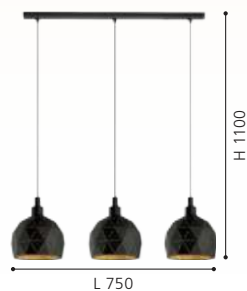



33344



97854

33344 ROCCAFORTE

pendant light; steel, white
Hängeleuchte; Stahl, weiss
luminaire en suspension; acier, blanc

H 1100, Ø 170



E14



1x 40W



9 002759 333447





97855

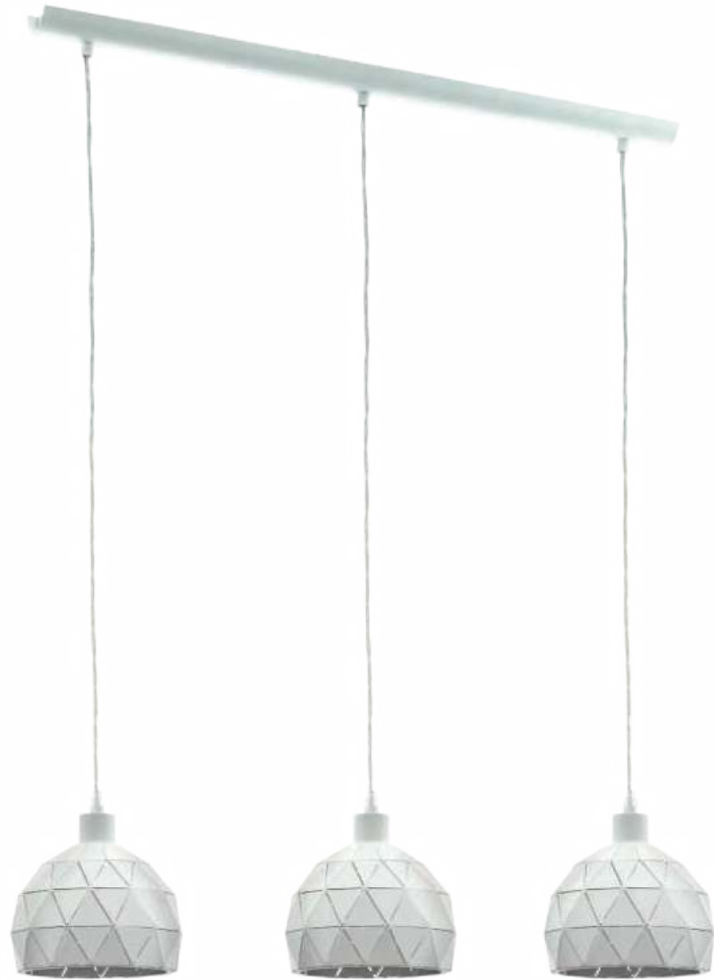

97857

97854 ROCCAFORTE

pendant light; steel, white
Hängeleuchte; Stahl, weiss
luminaire en suspension; acier, blanc

H 1100, Ø 300



E27 1x 60W



9 002759 978549



97855 ROCCAFORTE

pendant light; steel, white
Hängeleuchte; Stahl, weiss
luminaire en suspension; acier, blanc

H 1100, Ø 400



E27 1x 60W



9 002759 978556



97857 ROCCAFORTE

pendant light; steel, white
Hängeleuchte; Stahl, weiss
luminaire en suspension; acier, blanc

L 750, B 170, H 1100



E14 3x 40W



9 002759 978570

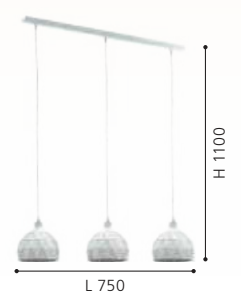



93373



93374



93373 CAMPILO

pendant light; plastic, white / paper threads, white
 Hängeleuchte; Kunststoff, weiss / Papierfäden, weiss
 luminaire en suspension; plastique, blanc / fils de papier, blanc

H 1100, Ø 450



9 002759 933739



93374 CAMPILO

pendant light; plastic, white / paper threads, beige
 Hängeleuchte; Kunststoff, weiss / Papierfäden, beige
 luminaire en suspension; plastique, blanc / fils de papier, beige

H 1100, Ø 450



9 002759 933746





95385



95383

95385 OBREGON

pendant light; steel, brown, creme, oak
 Hängeleuchte; Stahl, braun, creme, eiche
 luminaire en suspension; acier, marron, crème, chêne

H 1100, Ø 350



9 002759 953850

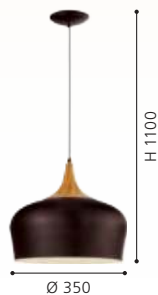

95383 OBREGON

pendant light; steel, creme, oak
 Hängeleuchte; Stahl, creme, eiche
 luminaire en suspension; acier, crème, chêne

H 1100, Ø 350



9 002759 953836





900161

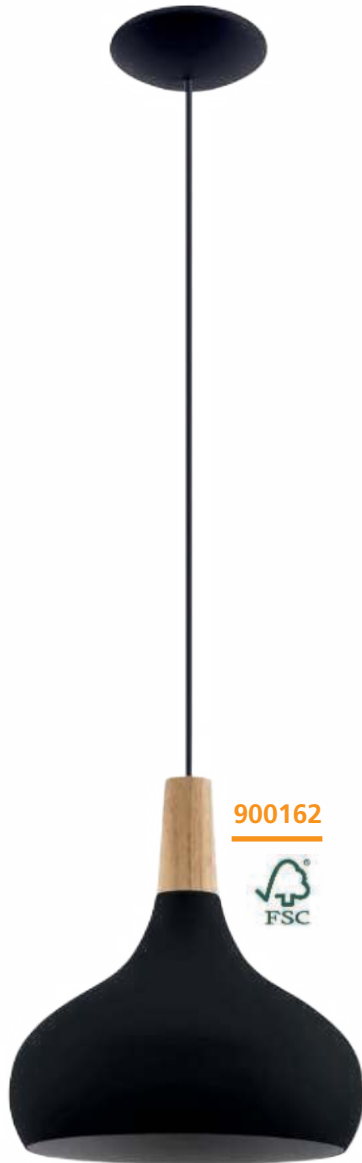

900162



900163



900161 SABINAR

pendant light; steel, wood, black, brown
Hängeleuchte; Stahl, Holz, schwarz, braun
luminaire en suspension; acier, bois, noir, marron

H 1100, Ø 180



E27



1x 40W



9 008606 235773



Ø 180

900162 SABINAR

pendant light; steel, wood, black, brown
Hängeleuchte; Stahl, Holz, schwarz, braun
luminaire en suspension; acier, bois, noir, marron

H 1100, Ø 280



E27



1x 40W



9 008606 235780



Ø 280

900163 SABINAR

pendant light; steel, wood, black, brown
Hängeleuchte; Stahl, Holz, schwarz, braun
luminaire en suspension; acier, bois, noir, marron

H 1100, Ø 400



E27



1x 40W



9 008606 235797

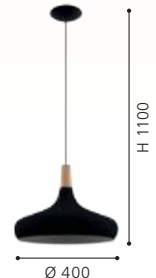

Ø 400



96981



96982



96983

96981 SABINAR

pendant light; steel, white / wood, brown
Hängeleuchte; Stahl, weiss / Holz, braun
luminaire en suspension; acier, blanc / bois, marron

H 1100, Ø 180



E27 1x 60W



9 002759 969813

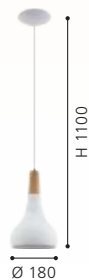

96982 SABINAR

pendant light; steel, white / wood, brown
Hängeleuchte; Stahl, weiss / Holz, braun
luminaire en suspension; acier, blanc / bois, marron

H 1100, Ø 280



E27 1x 60W



9 002759 969820

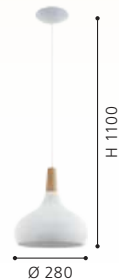

96983 SABINAR

pendant light; steel, white / wood, brown
Hängeleuchte; Stahl, weiss / Holz, braun
luminaire en suspension; acier, blanc / bois, marron

H 1100, Ø 400



E27 1x 60W



9 002759 969837

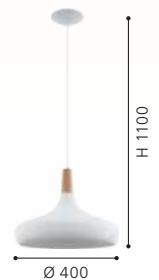



96985



96986



96985 SABINAR

pendant light; steel, brushed silver / wood, brown
 Hängeleuchte; Stahl, silber gebürstet / Holz, braun
 luminaire en suspension; acier, argent brossé / bois, marron

H 1100, Ø 280

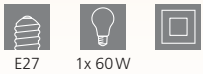

E27 1x 60W



9 002759 969851

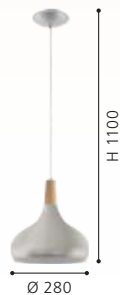

96986 SABINAR

pendant light; steel, brushed silver / wood, brown
 Hängeleuchte; Stahl, silber gebürstet / Holz, braun
 luminaire en suspension; acier, argent brossé / bois, marron

H 1100, Ø 400



E27 1x 60W



9 002759 969868





900186

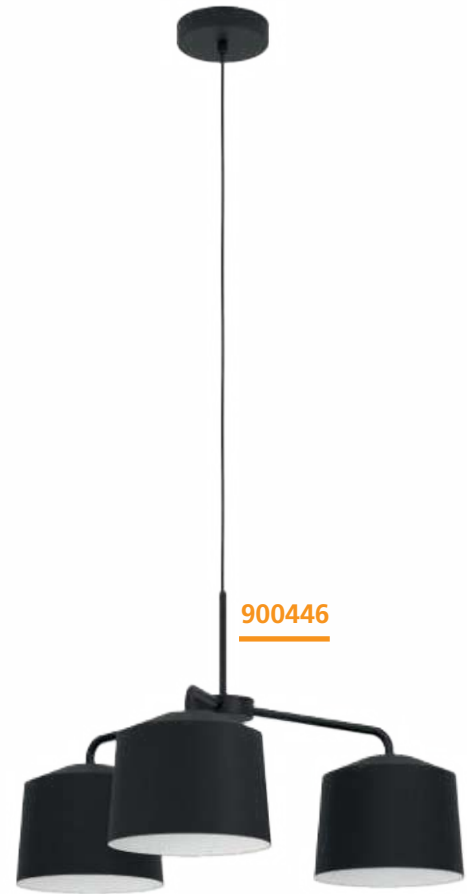

900446



900186 FILAGO

pendant light; steel, wood, black, brown / glass, black-grey-transparent
 Hängeleuchte; Stahl, Holz, schwarz, braun / Glas, schwarz-grau-transparent
 luminaire en suspension; acier, bois, noir, marron / verre, noir-gris-transparent
 L 880, B 145, H 1100



E27



4x 40W



9 008606 235339



900446 CAGUANES

pendant light; steel, black, white
 Hängeleuchte; Stahl, schwarz, weiss
 luminaire en suspension; acier, noir, blanc

H 1100, Ø 665



E27



3x 40W



9 008606 243969

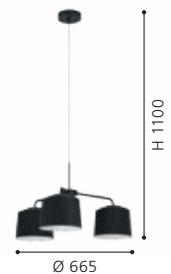



99702 VIGLIONI

pendant light; steel, wood, black, brown / glass vaporized, black-transparent

Hängeleuchte; Stahl, Holz, schwarz, braun / Glas bedampft, schwarz-transparent

luminaire en suspension; acier, bois, noir, marron / verre vaporisé, noir transparent

L 1060, B 165, H 1100

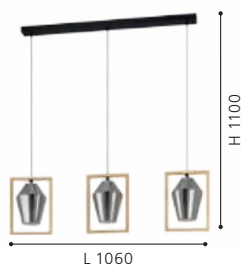

99701 VIGLIONI

pendant light; steel, wood, black, brown / glass vaporized, black-transparent

Hängeleuchte; Stahl, Holz, schwarz, braun / Glas bedampft, schwarz-transparent

luminaire en suspension; acier, bois, noir, marron / verre vaporisé, noir transparent

L 230, B 165, H 1100



900444 TARRAFO

pendant light; steel, wood, black, brown

Hängeleuchte; Stahl, Holz, schwarz, braun

luminaire en suspension; acier, bois, noir, marron

L 880, B 150, H 1100

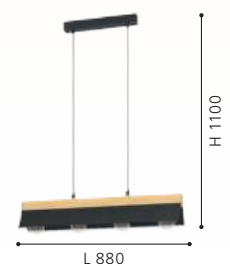

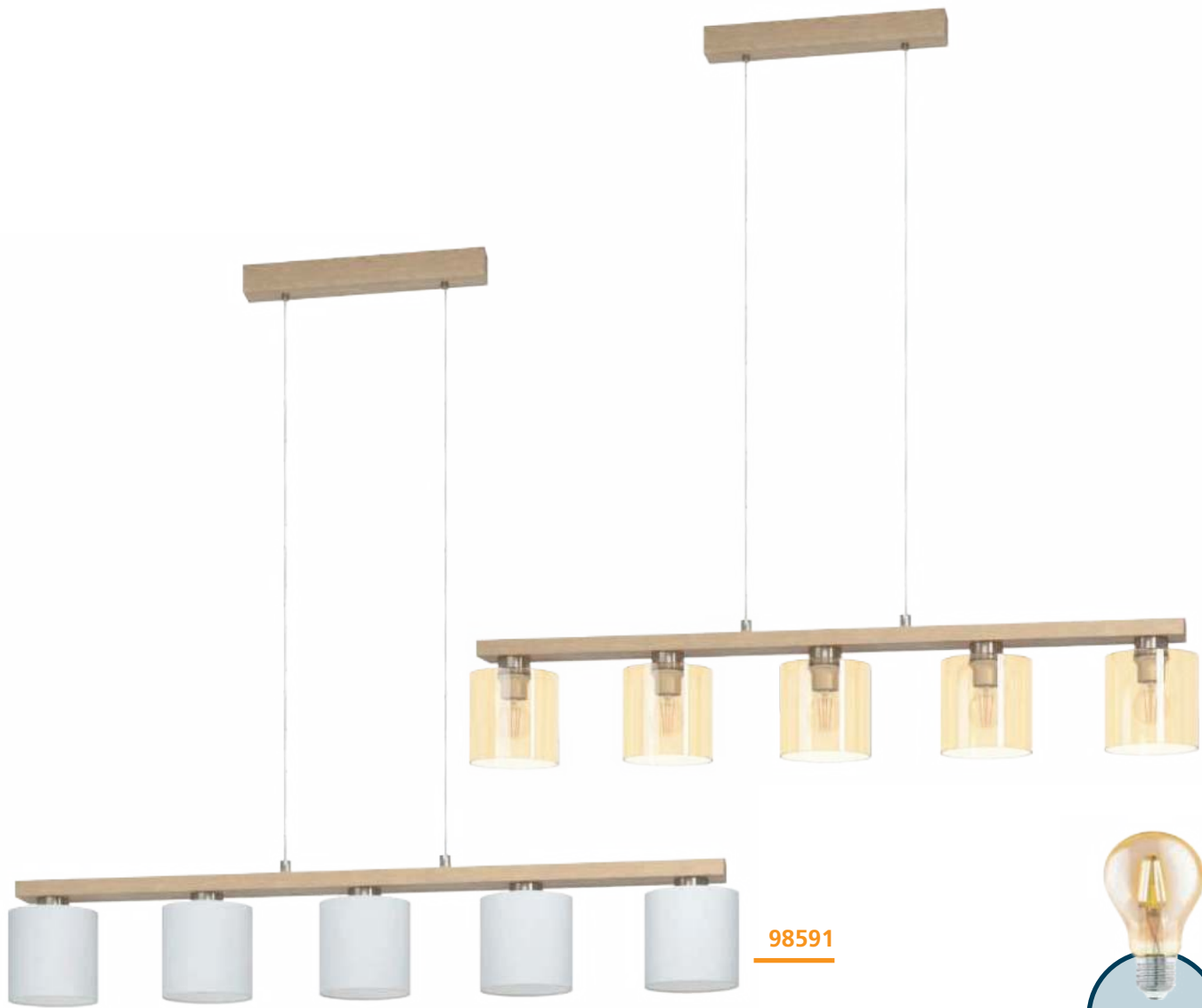

98592

98591



98592

98591 CASTRALVO

pendant light; steel, wood, satin nickel, brown / fabric, white
 Hängeleuchte; Stahl, Holz, nickel-matt, braun / Textil, weiss
 luminaire en suspension; acier, bois, nickel mat, marron / tissu, blanc

L 1210, B 150, H 1100



E27 5x 28W



9 002759 985912

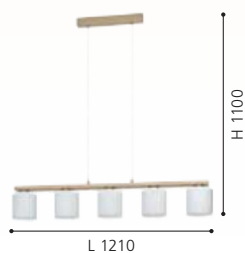

98592 CASTRALVO

pendant light; steel, wood, satin nickel, brown / glass vaporized, amber
 Hängeleuchte; Stahl, Holz, nickel-matt, braun / Glas bedampft, amber

luminaire en suspension; acier, bois, nickel mat, marron / verre vaporisé, ambre

L 1210, B 150, H 1100



E27 5x 28W



9 002759 985929

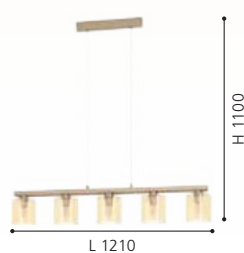

900313 CASTRALVO

pendant light; wood, steel, brown / fabric, black
 Hängeleuchte; Holz, Stahl, braun / Textil, schwarz
 luminaire en suspension; bois, acier, marron / tissu, noir

L 975, B 175, H 1100



E27 3x 40W



9 008606 235872

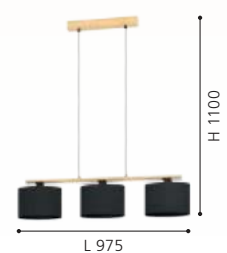

900313



CONTRISA

The luminaire is open at the top and has a beautiful play of light.

Die Leuchte ist nach oben offen und hat ein schönes Lichtspiel.

Le luminaire est ouvert en haut et a un beau jeu de lumière.

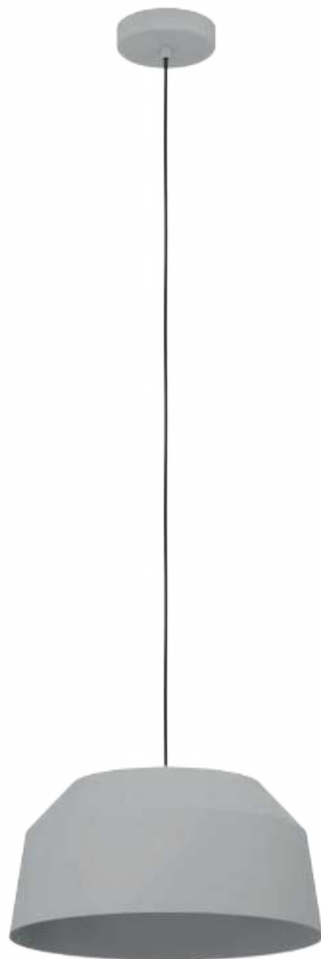

900379

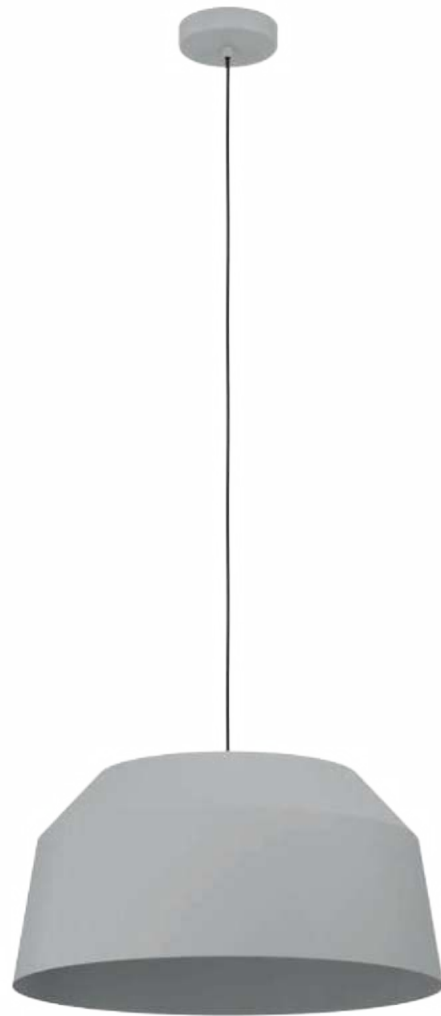

900381

900379 CONTRISA

pendant light; steel, grey
Hängeleuchte; Stahl, grau
luminaire en suspension; acier, gris

H 1100, Ø 380



E27

1x 40W



9 008606 243617

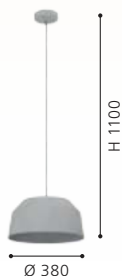

900381 CONTRISA

pendant light; steel, grey
Hängeleuchte; Stahl, grau
luminaire en suspension; acier, gris

H 1100, Ø 520



E27

1x 40W



9 008606 243624



900362 MARIEL

pendant light; steel, wood, light grey, brown
Hängeleuchte; Stahl, Holz, hellgrau, braun
luminaire en suspension; acier, bois, gris clair, marron

L 910, B 190, H 1100



E27

3x 40W



9 008606 239115

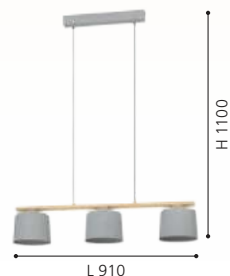



900362





95755



94935



94936

95755 NUVANO

pendant light; steel, brown, gold
Hängeleuchte; Stahl, braun, gold
luminaire en suspension; acier, marron, or

H 1100, Ø 480



E27



1x 60W



9 002759 957551



94935 GAETANO 1

pendant light; steel, black, gold
Hängeleuchte; Stahl, schwarz, gold
luminaire en suspension; acier, noir, or

H 1500, Ø 380



E27



1x 60W



9 002759 949358



94936 GAETANO 1

pendant light; steel, black, gold
Hängeleuchte; Stahl, schwarz, gold
luminaire en suspension; acier, noir, or

H 1500, Ø 530



E27



1x 60W



9 002759 949365





99663

LED

99663 NUVANO

pendant light; steel, black, gold
Hängeleuchte; Stahl, schwarz, gold
luminaire en suspension; acier, noir, or

L 985, B 225, H 1100



GU10



3x 4,5 W



3x
345 lm



9 002759 996635



INCL.





94938

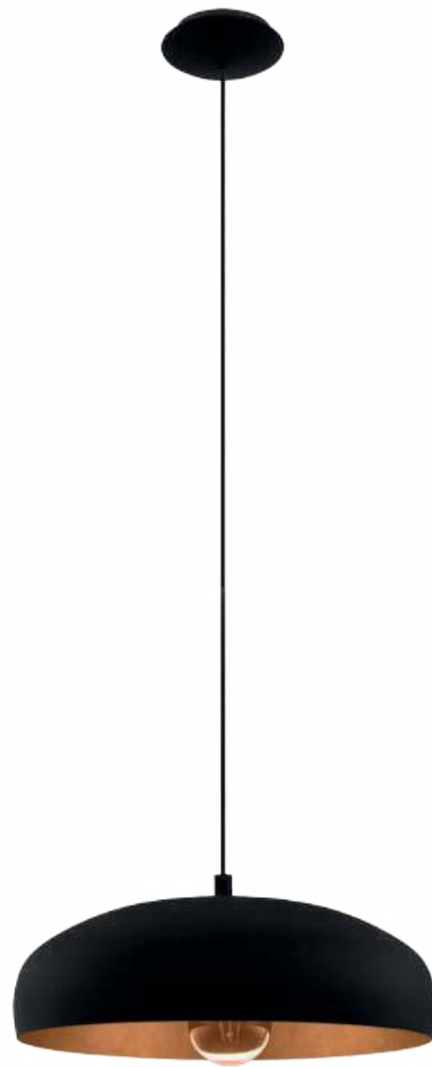

94605

94938 GAETANO 1

pendant light; steel, black, copper
 Hängeleuchte; Stahl, schwarz, kupfer
 luminaire en suspension; acier, noir, cuivre

H 1500, Ø 530



9 002759 949389



94605 MOGANO 1

pendant light; steel, black, copper
 Hängeleuchte; Stahl, schwarz, kupfer
 luminaire en suspension; acier, noir, cuivre

H 1100, Ø 400



9 002759 946050

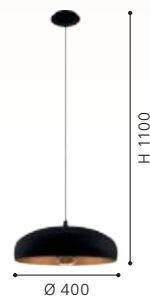

94606 MOGANO 1

pendant light; steel, white, copper
 Hängeleuchte; Stahl, weiss, kupfer
 luminaire en suspension; acier, blanc, cuivre

H 1100, Ø 400



9 002759 946067

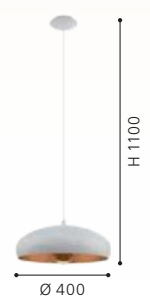



94606



98735

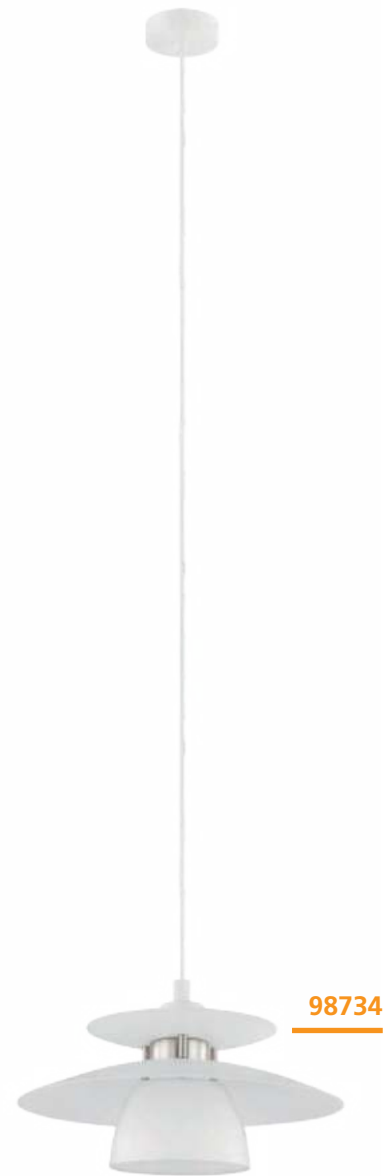

98734

98735 BRENDA

pendant light; steel, black, satin nickel
 Hängeleuchte; Stahl, schwarz, nickel-matt
 luminaire en suspension; acier, noir, nickel mat

H 1500, Ø 320



9 002759 987350



98734 BRENDA

pendant light; steel, white, satin nickel
 Hängeleuchte; Stahl, weiss, nickel-matt
 luminaire en suspension; acier, blanc, nickel mat

H 1500, Ø 320



9 002759 987343





87055



31666

87055 BRENDA

pendant light; plastic, steel, white, chrome / steel, white
 Hängeleuchte; Kunststoff, Stahl, weiss, chrom / Stahl, weiss
 luminaire en suspension; plastique, acier, blanc, chrome / acier, blanc

H 1300, Ø 430



E27 1x 60W



9 002759 870553

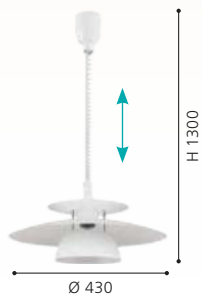

31666 BRENDA

pendant light; plastic, steel, black / steel, black, copper
 Hängeleuchte; Kunststoff, Stahl, schwarz / Stahl, schwarz, kupfer
 luminaire en suspension; plastique, acier, noir / acier, noir, cuivre

H 1100, Ø 430



E27 1x 60W



9 002759 316662

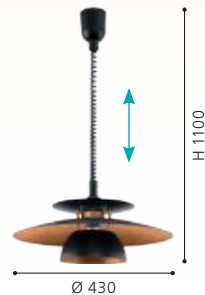

31666, 87055

This luminaires are flexible in height thanks to the spiral cables.

Diese Leuchten sind durch die Spiralkabel in der Höhe verstellbar.

La hauteur de ces lumières peut être ajustée à l'aide du câble en spirale.





87054

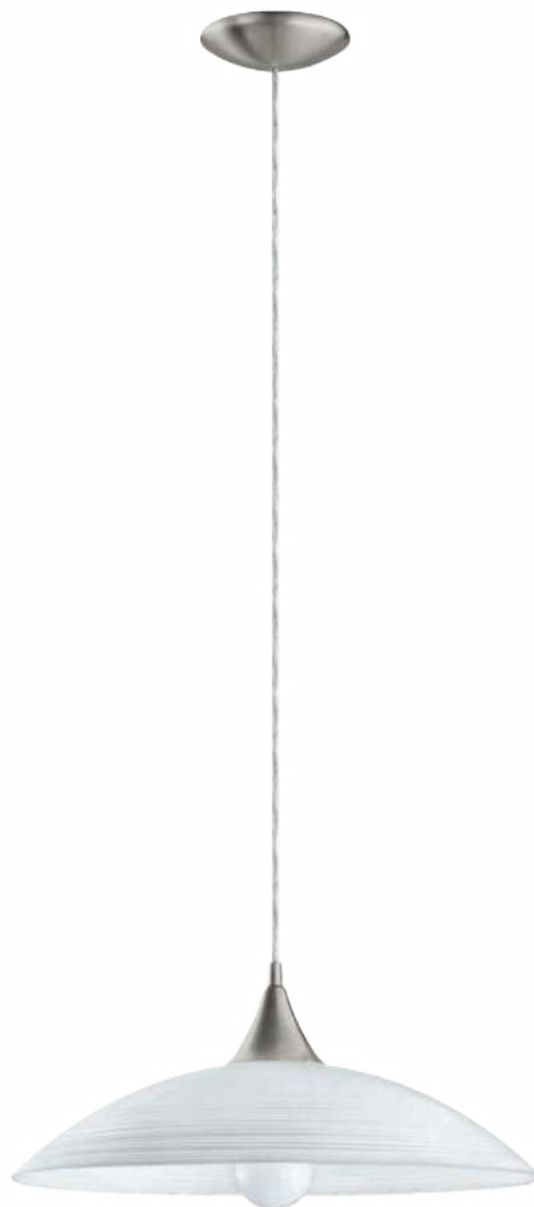

91496

87054 BRENDA

pendant light; steel, satin nickel / glass alabaster, white
 Hängeleuchte; Stahl, nickel-matt / Glas alabaster, weiss
 luminaire en suspension; acier, nickel mat / verre albâtre, blanc

H 1100, Ø 195



9 002759 870546



91496 LAZOLO

pendant light; steel, satin nickel / satin glass, white painted
 Hängeleuchte; Stahl, nickel-matt / Glas satiniert, weiss lackiert
 luminaire en suspension; acier, nickel mat / verre satiné, blanc laqué

H 1100, Ø 420



9 002759 914967

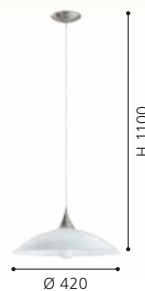

93468 MONTEFIO

pendant light; stainless steel, satin nickel / glass alabaster, white
 Hängeleuchte; Edelstahl, nickel-matt / Glas alabaster, weiss
 luminaire en suspension; acier inoxydable, nickel mat / verre albâtre, blanc

L 885, B 175, H 880 - 1300



3x 6,5W 2400lm



9 002759 934682





93468

LED



87008 LORD 2

pendant light; plastic, steel, silver, satin nickel / glass alabaster, white

Hängeleuchte; Kunststoff, Stahl, silber, nickel-matt / Glas alabaster, weiss

luminaire en suspension; plastique, acier, argent, nickel mat / verre albâtre, blanc

H 1100, Ø 360



E27 1x 60W

87009 LORD 2

pendant light; plastic, wood, silver, satin nickel, beech / glass alabaster, white

Hängeleuchte; Kunststoff, Holz, silber, nickel-matt, Buche / Glas alabaster, weiss

luminaire en suspension; plastique, bois, argent, nickel mat, hêtre / verre albâtre, blanc

H 1100, Ø 360



E27 1x 60W

3355, 87008, 87009



These luminaires are flexible in height thanks to the spiral cables.

Diese Leuchten sind durch die Spiralkabel in der Höhe verstellbar.

La hauteur de ces lumières peut être ajustée à l'aide du câble en spirale.



9 002759 870089

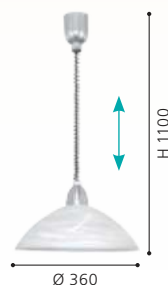

9 002759 870096

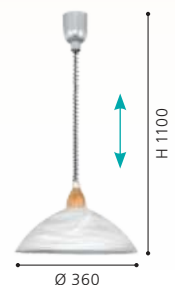



3355



90978



3355 ALESSANDRA

pendant light; plastic, white / glass alabaster, white
 Hängeleuchte; Kunststoff, weiss / Glas alabaster, weiss
 luminaire en suspension; plastique, blanc / verre albâtre, blanc

H 1100, Ø 380



9 002759 335502

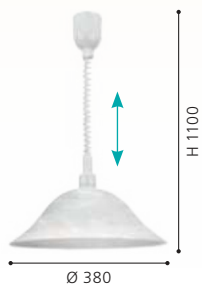

90978 ALBANY

pendant light; plastic, white / glass alabaster, white
 Hängeleuchte; Kunststoff, weiss / Glas alabaster, weiss
 luminaire en suspension; plastique, blanc / verre albâtre, blanc

H 1100, Ø 350



9 002759 909789

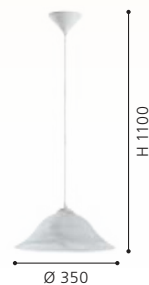

3355, 87008, 87009, 90978

These luminaires come with high quality processed alabaster glass.

Diese Leuchten sind mit hochwertigem Alabasterglas ausgestattet.

Ces luminaires viennent avec un abat-jour en verre d'albâtre haut de gamme.



3041 VETRO

pendant light; plastic, white / satin glass, white, purple, black
 Hängeleuchte; Kunststoff, weiss / Glas satiniert, weiss, lila, schwarz
 luminaire en suspension; plastique, blanc / verre satiné, blanc, violet, noir

H 1100, Ø 420



9 002759 304102

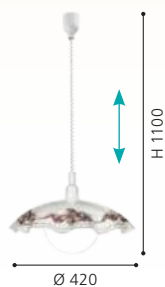

82786 VETRO

pendant light; plastic, white / glass, white, brown
 Hängeleuchte; Kunststoff, weiss / Glas, weiss, braun
 luminaire en suspension; plastique, blanc / verre, blanc, marron

H 1100, Ø 350



9 002759 827861

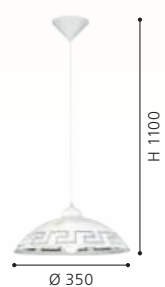

82785 VETRO

pendant light; plastic, white / satin glass, white
 Hängeleuchte; Kunststoff, weiss / Glas satiniert, weiss
 luminaire en suspension; plastique, blanc / verre satiné, blanc

H 1100, Ø 350



9 002759 827854

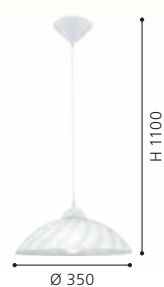



96474



96073



96072

3041, 96072, 96474

These luminaires are flexible in height thanks to the spiral cables.

Diese Leuchten sind durch die Spiralkabel in der Höhe verstellbar.

La hauteur de ces lumières peut être ajustée à l'aide du câble en spirale.



96474 ALVEZ

pendant light; plastic, white / glass with structure, white, clear
Hängeleuchte; Kunststoff, weiss / Glas mit Struktur, weiss, klar
luminaire en suspension; plastique, blanc / verre avec structure, blanc, transparent

H 1100, Ø 420



E27 1x 60W



9 002759 964740

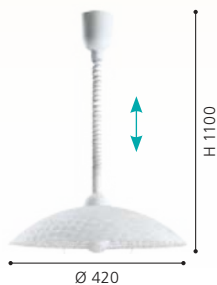

96073 VETRO

pendant light; plastic, white / satin glass, brilliant glass, white, clear
Hängeleuchte; Kunststoff, weiss / Glas satiniert, Brillantglas, weiss, klar
luminaire en suspension; plastique, blanc / verre satiné, verre brillant, blanc, transparent

H 1100, Ø 350



E27 1x 60W



9 002759 960735



96072 VETRO

pendant light; plastic, white / satin glass, brilliant glass, white, clear
Hängeleuchte; Kunststoff, weiss / Glas satiniert, Brillantglas, weiss, klar
luminaire en suspension; plastique, blanc / verre satiné, verre brillant, blanc, transparent

H 1100, Ø 415



E27 1x 60W



9 002759 960728

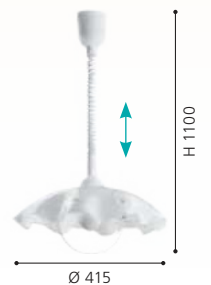

WALL & CEILING LUMINAIRES

WAND- & DECKENLEUCHTEN
APPLIQUES & PLAFONNIERS

OUR ALL-ROUNDERS

The range of wall and ceiling luminaires goes from simple to unusual designs. No matter if for the entrance area, hallway or your living rooms – these luminaires give the right light.

UNSERE ALLROUNDER

Das Sortiment an Wand- und Deckenleuchten reicht von schlichten bis hin zu ausgefallenen Designs. Egal ob für Eingangsbereich, Flur oder Ihre Wohnräume - diese Leuchten spenden das passende Licht.



NOS PASSE-PARTOUT

La gamme d'éclairages muraux et de plafonds s'étend de designs simples à extraordinaires. Que ce soit pour l'entrée, le couloir ou vos espaces d'habitat - ces luminaires apportent la lumière appropriée.



OVERVIEW

WALL & CEILING LUMINAIRES

 ALTAFLOR p. 456 - 458	 MONIROTE p. 457, 459	 RUOTALE p. 460	 ULISANO p. 460	 PADULARI p. 460	 ROLIMARE p. 461	 GAFARES p. 462 - 463	 IPOLITTO p. 464
 AMONTILLADO p. 464	 SPADAFORA p. 464	 ZAMPOTE p. 465	 TIRRENARA p. 466	 MARINELLO 1 p. 466	 MARINELLO p. 467	 MIRLAS p. 468	 TAMURIA p. 470
 BORDONARA p. 472	 MARMORATA p. 473	 BOCADELLA 1 p. 474	 MUSARA p. 475	 TREMEDAL p. 475	 MESSINARO p. 476	 BELSIANA p. 476	 ENCINITOS p. 477
 BELSIANA 1 p. 477	 MONTEBALDO p. 478	 BARRANCAS p. 478	 MORDAZO p. 479	 STAITI p. 479	 SILENTINA p. 480 - 481	 MACCHIONE p. 481	 PIEDRITAS p. 482
 MOGANO p. 484 - 485	 MOGANO 2 p. 487	 VALCASOTTO p. 488, 538	 VALCASOTTO 1 p. 489	 TARRAFO p. 489	 BASURTU p. 490	 LORETO p. 491	 LORETO 1 p. 491
 MARIEL p. 493	 FILAGO p. 493	 MAROJALES p. 493	 CABO p. 494	 CONDRADE 1 p. 494	 CLEMENTE p. 496	 ACOLLA 1 p. 497	 ACOLLA p. 497
 CARDITO p. 497	 FRADELO 1 p. 498 - 499	 FRADELO p. 500 - 502	 SORRENTA 1 p. 503	 VALLEMARE p. 503	 CANICOSA 2 p. 504	 MONTENOVO p. 505	 POZONDON p. 505

							
GIRON p. 506	GIRON-S p. 507	FRANIA p. 508-509, 512-513	FRANIA-S p. 510-511, 514-515	ZAMUDILO p. 516	SILERAS p. 516-517	RUIDERA p. 517	CAPASSO 1 p. 518
							
VOLTAGO 2 p. 518	LANCIANO p. 520-521	LANCIANO 1 p. 520-521	FERENTINO p. 522-523	BATTISTONA p. 524	BENARIBA p. 525	COMPETA 1 p. 527-528	PALERMO 2 p. 529
							
CAPASSO p. 530	RENDE p. 531	NIEVES 1 p. 532	NIEVES p. 533	PESCAITO p. 534	MUSURITA p. 534-535	LAURITO p. 536	SELUCI p. 536-537
							
LUPPINERIA p. 539	PENJAMO p. 540	CALAGRANO p. 541	MENTALURGIA p. 542	REDUCTA 2 p. 543	ELLA p. 544	DURELO p. 545	PLANET p. 546
							
PLANET 1 p. 546-549	MARGITTA 1 p. 551, 554	MARS 1 p. 552-553	MARS p. 553, 558	SCALEA 1 p. 554	RAYA p. 554	GRAFIK p. 556	NEMO p. 556
							
SALOME p. 558-559	MESTRE p. 560-561	IMPERIAL p. 560	ALMERA p. 561	PASCAL 1 p. 561	CAMPANIA p. 562	GERBERA 1 p. 562	COLTI p. 562
							
SAN PERI p. 564	STAITI 1 p. 564	TAZZOLI p. 567	CIGLIE p. 567	CARTIGNANO p. 568	CIVITATE p. 569	TIMPAROSSA p. 570	GURARE p. 571

 This product is available in different colors and shapes./ Dieser Artikel ist in unterschiedlichen Farben und Formen verfügbar.
Cet article est disponible en différentes couleurs et formes.

OVERVIEW

WALL & CEILING LUMINAIRES

							
ZINACUA p.571	ZUBIALDE p.572-573	ONO 2 p.573	MACCACARI p.574	FELONICHE p.575	SANIA 4 p.576-577	PASSA p.578-581	GASCUERIA p.582
							
ELIZONDO p.582	FALICETTO p.582	HAYES p.583	TANURA p.584	GUANAL p.584	MONGODIO 1 p.586	ELGVERO p.587	CADEGAL p.588-589
							
REMIDOS p.589	METRASS p.590	METRASS 2 p.591	METRASS 1 p.593	SARGINTO p.594-595			



This product is available in different colors and shapes./ Dieser Artikel ist in unterschiedlichen Farben und Formen verfügbar.
Cet article est disponible en différentes couleurs et formes.



FUNCTIONAL OVERVIEW

FUNKTIONSÜBERSICHT

PRÉSENTATION FONCTIONNELLE

The listed boxes inform you about the respective functions of our wall and ceiling luminaires. You will find them on the catalogue pages next to the product illustrations. The coloured symbol area indicates the special characteristics of the respective luminaire/luminaire family, e.g. dimming function. In the grey area below you will find detailed information on this function, e.g. dimmable from 10% - 100%.

For luminaires that come with a remote control, you can control the respective functions with the remote control. For luminaires without remote control, the functions can be switched directly on the wall switch.

Die angeführten Boxen informieren Sie über die jeweiligen Funktionen unserer Wand- und Deckenleuchten. Sie finden sie auf den Katalogseiten jeweils neben den Produktabbildungen. Der farbige Symbolbereich weist darauf hin, welche besonderen Eigenschaften die jeweilige Leuchte/Leuchtenfamilie bietet, z.B. Dimmfunktion. Im grauen Bereich darunter finden Sie detaillierte Angaben zu dieser Funktion, z.B. dimmbar von 10% - 100%.

Ist eine Fernbedienung im Lieferumfang enthalten, können Sie die jeweiligen Funktionen mit der Fernbedienung steuern. Bei Leuchten ohne Fernbedienung können die Funktionen direkt am Wandschalter geschaltet werden.

Les boîtes de dialogue présentes vous informent sur les fonctions respectives de nos appliques et plafonniers. Vous les trouverez sur les pages du catalogue à côté des illustrations des produits. La zone colorée des symboles indique les caractéristiques particulières de chaque luminaire/famille de luminaires, par ex. la fonction de gradation. Dans la zone grise ci-dessous, vous trouverez des informations détaillées sur cette fonction, par ex. graduable de 10% - 100%.

Pour les luminaires équipés d'une télécommande, vous pouvez commander les fonctions correspondantes à l'aide de la télécommande. Pour les luminaires sans télécommande, les fonctions peuvent être commutées directement sur l'interrupteur mural.



DIMMABLE

e.g./z.B./par ex.
10 - 100%

The brightness of the luminaire can be steplessly controlled.

Die Helligkeit der Leuchte kann stufenlos im angegebenen Bereich gesteuert werden.

La luminosité du luminaire peut être réglée en continu.



STEP DIMMING

e.g./z.B./par ex.
10%/50%/100%

The brightness of the luminaire can be controlled step by step.

Die Helligkeit der Leuchte kann schrittweise gesteuert werden.

La luminosité du luminaire peut être réglée pas à pas.



TUNABLE WHITE

e.g./z.B./par ex.
2700 - 6500 K

The colour temperature can be controlled from warm to cold white LED light.

Die Farbtemperatur kann von warm- bis kaltweißem LED-Licht gesteuert werden.

La température de couleur peut être réglée de la lumière DEL blanche chaude à la lumière DEL blanche froide.



STEP TUNABLE

e.g./z.B./par ex.
3000/4000/5000 K

The colour temperature of warm to cold white LED light can be changed directly on the wall switch in 3 preset steps.

Die Farbtemperatur von warm- bis kaltweißem LED-Licht kann direkt am Wandschalter in 3 voreingestellten Schritten verändert werden.

La température de couleur peut être modifiée de la lumière DEL blanche chaude à la lumière DEL blanche froide directement sur l'interrupteur mural en 3 étapes prédéfinies.



NIGHT LIGHT FUNCTION

Luminaires can be switched to a night light mode. With included remote control or, for luminaires without remote control, via wall switch (ambient light).

Leuchten können auf einen Nacht-Licht-Modus umgeschaltet werden. Mit inkludierter Fernbedienung oder bei Leuchten ohne Fernbedienung per Wandschalter (Ambient light).

Les luminaires peuvent être commutés en mode veilleuse. Avec télécommande incluse ou, pour les luminaires sans télécommande, via interrupteur mural (lumière ambiante).



TIMER FUNCTION

e.g./z.B./par ex.
off after 30 sec.

The luminaire switches itself off after a preset time.

Die Leuchte schaltet sich nach einer voreingestellten Zeit selbst aus.

La lumière s'éteint d'elle-même après une durée prédéfinie.





99788

LED

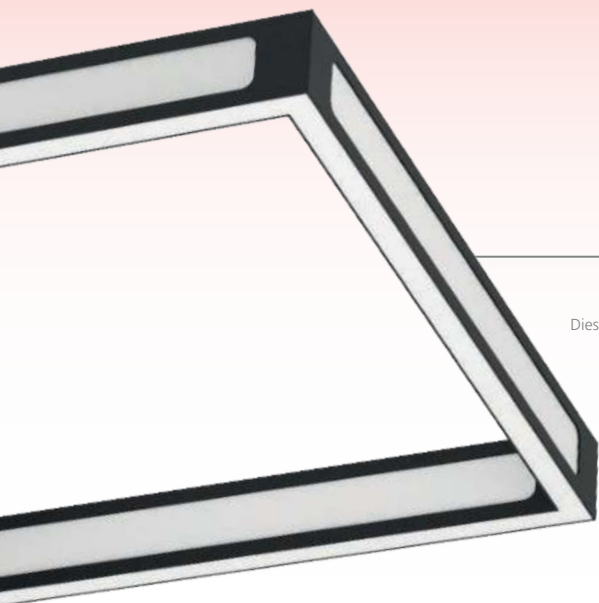

ALTAFLOR

These luminaires have an additional glow on the inside.

Diese Leuchten haben einen zusätzlichen Lichtschein nach Innen.

Ces luminaires ont une lueur supplémentaire à l'intérieur.

99788 ALTAFLOR

ceiling light; steel, black / plastic, white
Deckenleuchte; Stahl, schwarz / Kunststoff, weiss
plafonnier; acier, noir / plastique, blanc

L 650, B 300, H 70



8x 2,8W



3040lm



9 002759 997885

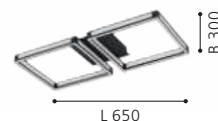



99787



99789

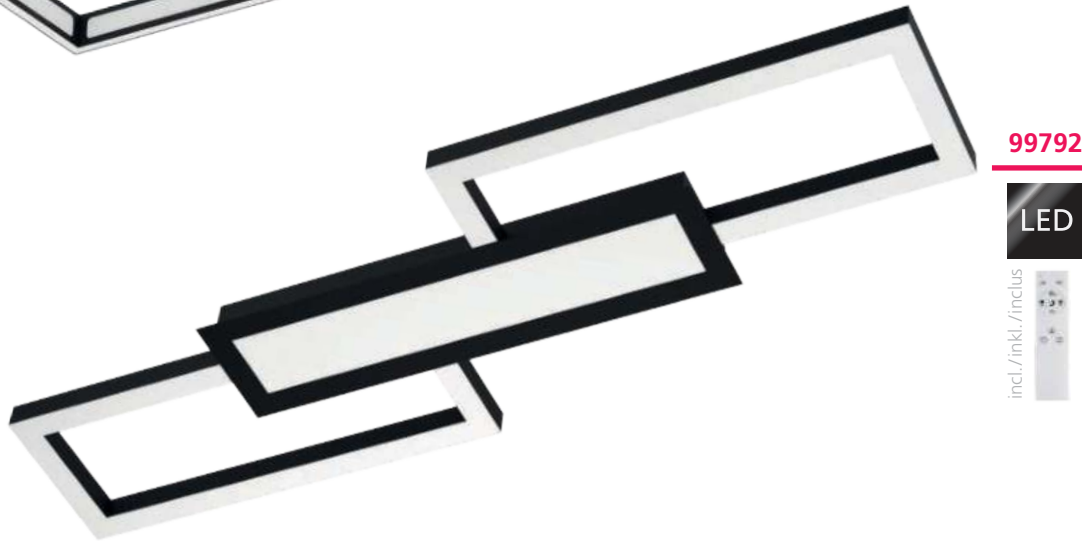

99792



99787 ALTAFLOR

ceiling light; steel, black / plastic, white
Deckenleuchte; Stahl, schwarz / Kunststoff, weiss
plafonnier; acier, noir / plastique, blanc

L 315, B 315, H 70



4x 2,8W 1520lm

99789 ALTAFLOR

ceiling light; steel, black / plastic, white
Deckenleuchte; Stahl, schwarz / Kunststoff, weiss
plafonnier; acier, noir / plastique, blanc

L 1000, B 315, H 70



12x 2,8W 4560lm

99792 MONIROTE

ceiling light; steel, aluminium, black / plastic, white
Deckenleuchte; Stahl, Alu, schwarz / Kunststoff, weiss
plafonnier; acier, aluminium, noir / plastique, blanc

L 780, H 45



37W 4450lm

Remote



9 002759 997878

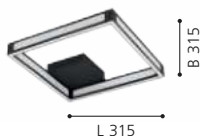

9 002759 997892

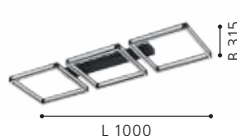

9 002759 997922

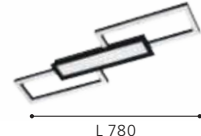



99784

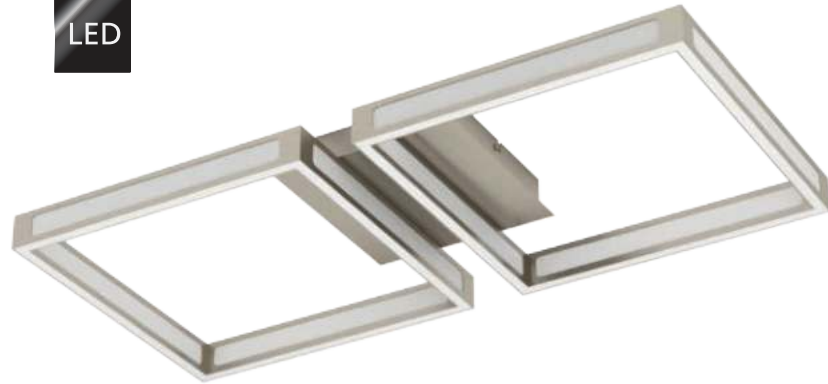

99785



99786



99784 ALTAFLOR

ceiling light; steel, satin nickel / plastic, white
Deckenleuchte; Stahl, nickel-matt / Kunststoff, weiss
plafonnier; acier, nickel mat / plastique, blanc

L 315, B 315, H 70



4x 2,8W 1520lm

99785 ALTAFLOR

ceiling light; steel, satin nickel / plastic, white
Deckenleuchte; Stahl, nickel-matt / Kunststoff, weiss
plafonnier; acier, nickel mat / plastique, blanc

L 650, B 300, H 70



8x 2,8W 3040lm

99786 ALTAFLOR

ceiling light; steel, satin nickel / plastic, white
Deckenleuchte; Stahl, nickel-matt / Kunststoff, weiss
plafonnier; acier, nickel mat / plastique, blanc

L 1000, B 315, H 70



12x 2,8W 4560lm



9 002759 997847

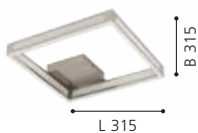

9 002759 997854

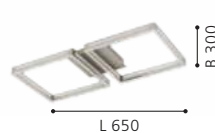

9 002759 997861

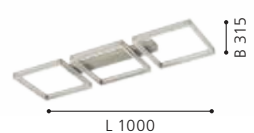



99791

LED

incl./inkl./inclus

99791 MONIROTE

ceiling light; steel, aluminium, satin nickel / plastic, white
 Deckenleuchte; Stahl, Alu, nickel-matt / Kunststoff, weiss
 plafonnier; acier, aluminium, nickel mat / plastique, blanc

L 780, B 260, H 45



37W



4450lm



Remote



9 002759 997915

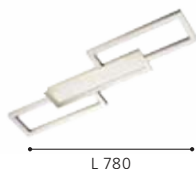

L 780



ALTAFLOR

These luminaires have an additional glow on the inside.

Diese Leuchten haben einen zusätzlichen Lichtschein nach Innen.

Ces luminaires ont une lueur supplémentaire à l'intérieur.



900471

LED

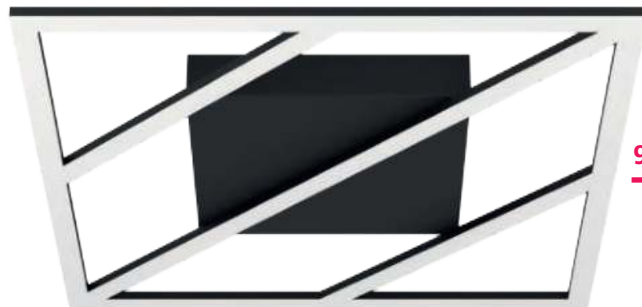

900596

LED



incl./inkl./inclus



900597

LED



incl./inkl./inclus

900471 RUOTALE

ceiling light; aluminium, steel, black / plastic, white
Deckenleuchte; Alu, Stahl, schwarz / Kunststoff, weiss
plafonnier; aluminium, acier, noir / plastique, blanc

H 55, Ø 450



36W

4400lm

900596 ULISANO

ceiling light; aluminium, steel, black / plastic, white
Deckenleuchte; Alu, Stahl, schwarz / Kunststoff, weiss
plafonnier; aluminium, acier, noir / plastique, blanc

L 420, B 420, H 55



21W

3000lm

900597 PADULARI

ceiling light; aluminium, steel, black / plastic, white
Deckenleuchte; Alu, Stahl, schwarz / Kunststoff, weiss
plafonnier; aluminium, acier, noir / plastique, blanc

L 535, B 470, H 50



25,6W

3800lm

Remote



9 008606 244096



9 008606 244959



9 008606 244966





900419

LED



99395

LED

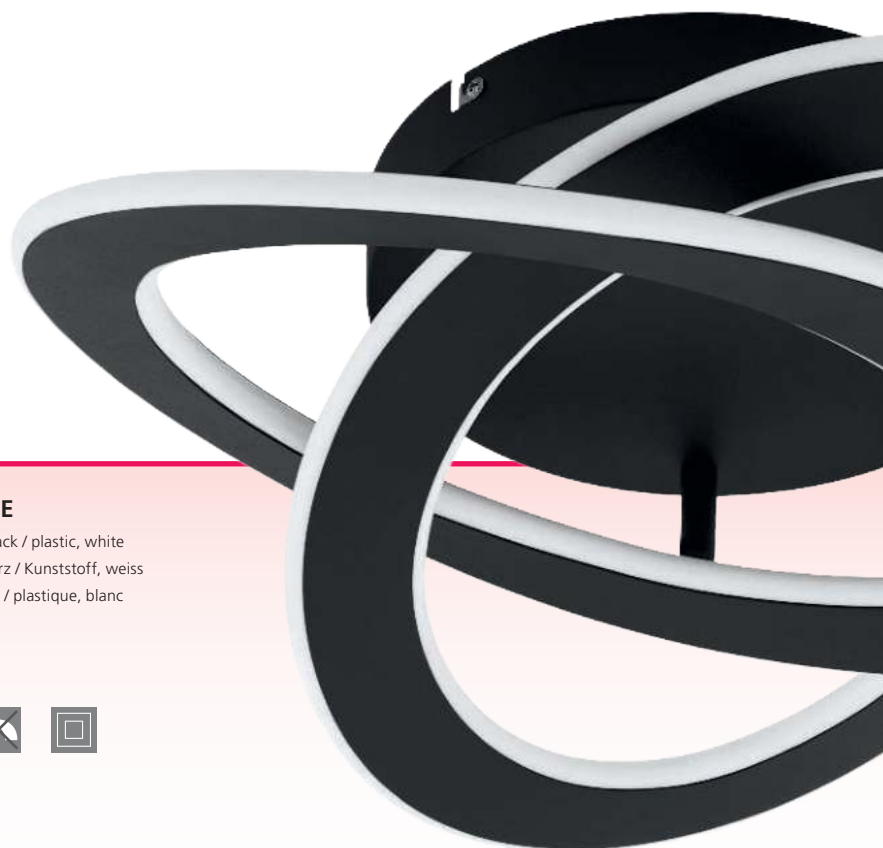

900419 ROLIMARE

ceiling light; aluminium, satin nickel / plastic, white
Deckenleuchte; Alu, nickel-matt / Kunststoff, weiss
plafonnier; aluminium, nickel mat / plastique, blanc

L 420, B 400, H 130



35W 5500lm

99395 ROLIMARE

ceiling light; aluminium, black / plastic, white
Deckenleuchte; Alu, schwarz / Kunststoff, weiss
plafonnier; aluminium, noir / plastique, blanc

L 420, B 400, H 130



35W 5500lm



9 008606 240999

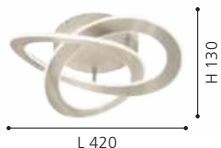

L 420



9 002759 993955



L 420





900421



incl./inkl./inclus



900422



incl./inkl./inclus



900421 GAFARES

ceiling light; aluminium, steel, black, white / plastic, white
 Deckenleuchte; Alu, Stahl, schwarz, weiss / Kunststoff, weiss
 plafonnier; aluminium, acier, noir, blanc / plastique, blanc

L 405, B 290, H 55



15W



2100lm



Remote



DESIGN
HIGHLIGHT
DETAIL



9 008606 241002





900423

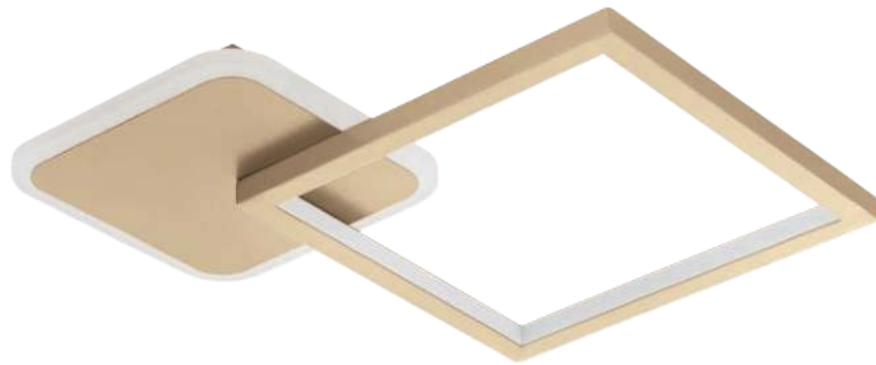

900424



900422 GAFARES

ceiling light; aluminium, steel, black, white / plastic, white
Deckenleuchte; Alu, Stahl, schwarz, weiss / Kunststoff, weiss
plafonnier; aluminium, acier, noir, blanc / plastique, blanc

L 330, B 330, H 50



900423 GAFARES

ceiling light; aluminium, steel, gold, white / plastic, white
Deckenleuchte; Alu, Stahl, gold, weiss / Kunststoff, weiss
plafonnier; aluminium, acier, or, blanc / plastique, blanc

L 405, B 290, H 55



900424 GAFARES

ceiling light; aluminium, steel, gold, white / plastic, white
Deckenleuchte; Alu, Stahl, gold, weiss / Kunststoff, weiss
plafonnier; aluminium, acier, or, blanc / plastique, blanc

L 330, B 330, H 50



9 008606 241026

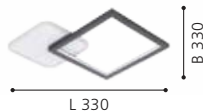

9 008606 241019



9 008606 241033

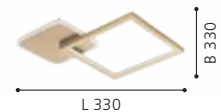



99817

LED



98491

LED



98494

LED

99817 IPOLITTO

ceiling light; aluminium, steel, black / plastic, white
 Deckenleuchte; Alu, Stahl, schwarz / Kunststoff, weiss
 plafonnier; aluminium, acier, noir / plastique, blanc

L 995, B 165, H 245

LED

warm
WHITE



4x 7,5W 3600lm

98491 AMONTILLADO

ceiling light; aluminium, steel, black / plastic, white
 Deckenleuchte; Alu, Stahl, schwarz / Kunststoff, weiss
 plafonnier; aluminium, acier, noir / plastique, blanc

L 1125, B 8

LED

warm
WHITE



2x 13,5W 3500lm

98494 SPADAFORA

ceiling light; aluminium, steel, black / plastic, clear, white
 Deckenleuchte; Alu, Stahl, schwarz / Kunststoff, klar, weiss
 plafonnier; aluminium, acier, noir / plastique, transparent, blanc

L 1160, B 80, H 100

LED

warm
WHITE



21,5W 2500lm



9 002759 998172



L 995



9 002759 984915



L 1125



9 002759 984946



L 1160



900328

LED



900329

LED



900328 ZAMPOTE

ceiling light; aluminium, steel, white, black / plastic, white
Deckenleuchte; Alu, Stahl, weiss, schwarz / Kunststoff, weiss
plafonnier; aluminium, acier, blanc, noir / plastique, blanc

H 50, Ø 420



25W 3400lm

900329 ZAMPOTE

ceiling light; aluminium, steel, white, black / plastic, white
Deckenleuchte; Alu, Stahl, weiss, schwarz / Kunststoff, weiss
plafonnier; aluminium, acier, blanc, noir / plastique, blanc

L 380, B 380, H 50



25W 3300lm



9 008606 238095



9 008606 238101

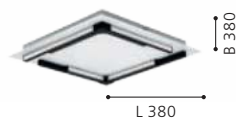



900603

LED



incl./inkl./inclus

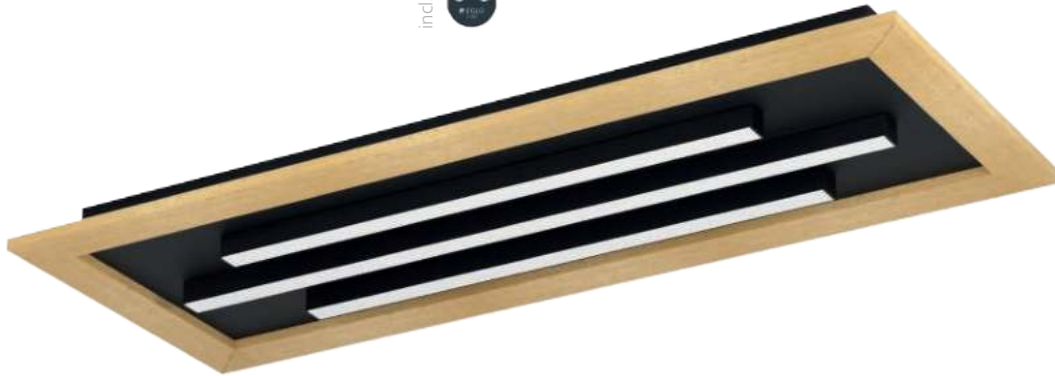

900604

LED



incl./inkl./inclus



99793

LED

900603 TIRRENARA

ceiling light; steel, wood, black, brown / plastic, white
Deckenleuchte; Stahl, Holz, schwarz, braun / Kunststoff, weiss
plafonnier; acier, bois, noir, marron / plastique, blanc

L 370, B 370, H 55



4x 5,4W 2600lm

Remote

900604 TIRRENARA

ceiling light; steel, wood, black, brown / plastic, white
Deckenleuchte; Stahl, Holz, schwarz, braun / Kunststoff, weiss
plafonnier; acier, bois, noir, marron / plastique, blanc

L 780, B 305, H 55



2x 9,2W 3960lm 1x 13,7W

Remote



99793 MARINELLO 1

ceiling light; aluminium, steel, wood, black, brown / plastic, white
Deckenleuchte; Alu, Stahl, Holz, schwarz, braun / Kunststoff, weiss
plafonnier; aluminium, acier, bois, noir, marron / plastique, blanc

L 500, B 500, H 90



4x 5,3W 2800lm



9 008606 245017

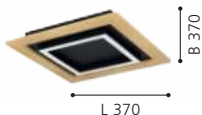

9 008606 245024

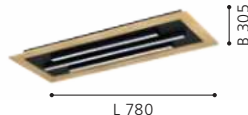

9 002759 997939

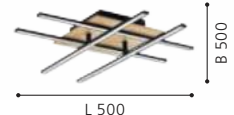



99659

LED

incl./inkl./inclus



99659 MARINELLO

ceiling light; aluminium, steel, wood, black, brown / plastic, white

Deckenleuchte; Alu, Stahl, Holz, schwarz, braun / Kunststoff, weiss

plafonnier; aluminium, acier, bois, noir, marron / plastique, blanc

L 485, B 485, H 55



2x 17W



3800lm



4,2W



550lm



Remote



9 002759 996598

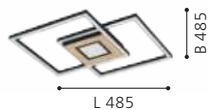



98861



MIRLAS



98862



98861 MIRLAS

ceiling light; wood, steel, brown / plastic, white
Deckenleuchte; Holz, Stahl, braun / Kunststoff, weiss
plafonnier; bois, acier, marron / plastique, blanc

L 360, B 210, H 90



E27



2x 9W



9 002759 988616



98862 MIRLAS

ceiling light; wood, steel, brown / plastic, white
Deckenleuchte; Holz, Stahl, braun / Kunststoff, weiss
plafonnier; bois, acier, marron / plastique, blanc

L 690, B 270, H 90



E27



4x 9W



9 002759 988623

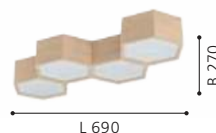

98863 MIRLAS

ceiling light; wood, steel, brown / plastic, white
Deckenleuchte; Holz, Stahl, braun / Kunststoff, weiss
plafonnier; bois, acier, marron / plastique, blanc

L 540, B 520, H 90



E27



6x 9W



9 002759 988630

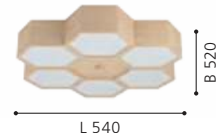



98863



99656



TUMARIA

This luminaires have rotatable panels in wood look and black.

Diese Artikel verfügen über Platten in Holzoptik und schwarz zum Wechseln.

Ces luminaires a des panneaux en bois optique et noir à changer.

99656 TAMURIA

ceiling light; steel, wood, black, brown / plastic, white
Deckenleuchte; Stahl, Holz, schwarz, braun / Kunststoff, weiss
plafonnier; acier, bois, noir, marron / plastique, blanc

L 435, B 435, H 70



21W 2700lm

99655 TAMURIA

ceiling light; steel, wood, black, brown / plastic, white
Deckenleuchte; Stahl, Holz, schwarz, braun / Kunststoff, weiss
plafonnier; acier, bois, noir, marron / plastique, blanc

L 285, B 285, H 60



10,8W 1300lm



9 002759 996567

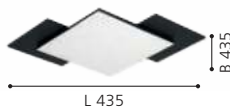

9 002759 996550





99655

LED



900571

LED

incl./inkl./inclus



900572

LED

incl./inkl./inclus



900573

LED

incl./inkl./inclus



900571 BORDONARA

ceiling light; aluminium, steel, black, white / plastic, white
Deckenleuchte; Alu, Stahl, schwarz, weiss / Kunststoff, weiss
plafonnier; aluminium, acier, noir, blanc / plastique, blanc

L 450, B 450

LED

21,5W 2800lm



900572 BORDONARA

ceiling light; aluminium, steel, black, white / plastic, white
Deckenleuchte; Alu, Stahl, schwarz, weiss / Kunststoff, weiss
plafonnier; aluminium, acier, noir, blanc / plastique, blanc

L 595, B 595

LED

36W 4900lm



900573 BORDONARA

ceiling light; aluminium, steel, black, white / plastic, white
Deckenleuchte; Alu, Stahl, schwarz, weiss / Kunststoff, weiss
plafonnier; aluminium, acier, noir, blanc / plastique, blanc

L 1195, B 295

LED

35W 5400lm



9 008606 244720



9 008606 244737



9 008606 244744





900558



900559



900561



900558 MARMORATA

ceiling light; aluminium, steel, black, white / plastic, white
Deckenleuchte; Alu, Stahl, schwarz, weiss / Kunststoff, weiss
plafonnier; aluminium, acier, noir, blanc / plastique, blanc

H 70, Ø 450



18W 2300lm 9W 1100lm



9 008606 244614



900559 MARMORATA

ceiling light; aluminium, steel, black, white / plastic, white
Deckenleuchte; Alu, Stahl, schwarz, weiss / Kunststoff, weiss
plafonnier; aluminium, acier, noir, blanc / plastique, blanc

L 445, B 445



19W 2400lm 9W 1200lm



9 008606 244621



900561 MARMORATA

ceiling light; aluminium, steel, black, white / plastic, white
Deckenleuchte; Alu, Stahl, schwarz, weiss / Kunststoff, weiss
plafonnier; aluminium, acier, noir, blanc / plastique, blanc

L 595, B 295



17W 2400lm 9W 1100lm



9 008606 244638





98319



98317



98318

98319 BOCADELLA 1

ceiling light; steel, black
Deckenleuchte; Stahl, schwarz
plafonnier; acier, noir

H 360, Ø 920



E27



12x 60W



9 002759 983192

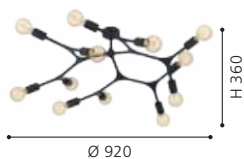

Ø 920

H 360

98317 BOCADELLA 1

ceiling light; steel, black
Deckenleuchte; Stahl, schwarz
plafonnier; acier, noir

H 215, Ø 345



E27



3x 60W



9 002759 983178

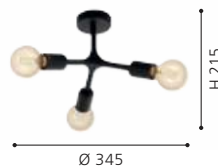

Ø 345

H 215

98318 BOCADELLA 1

ceiling light; steel, black
Deckenleuchte; Stahl, schwarz
plafonnier; acier, noir

H 365, Ø 640



E27



9x 60W



9 002759 983185

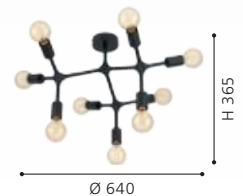

Ø 640

H 365



98679



98507

98679 MUSARA

ceiling light; steel, black
Deckenleuchte; Stahl, schwarz
plafonnier; acier, noir

H 850, Ø 790

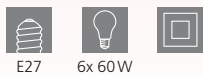

9 002759 986797

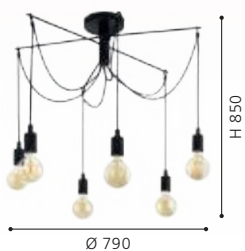

98507 TREMEDAL

ceiling light; steel, black
Deckenleuchte; Stahl, schwarz
plafonnier; acier, noir

H 215, Ø 560



9 002759 985073

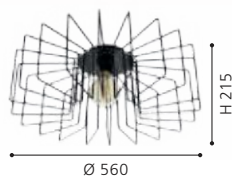



900367



98034



98035

900367 MESSINARO

ceiling light; steel, black, brushed brass
 Deckenleuchte; Stahl, schwarz, messing-gebürstet
 plafonnier; acier, noir, laiton brossé

L 720, B 280, H 115



98034 BELSIANA

ceiling light; steel, black
 Deckenleuchte; Stahl, schwarz
 plafonnier; acier, noir

L 890, B 510, H 350



98035 BELSIANA

ceiling light; steel, black
 Deckenleuchte; Stahl, schwarz
 plafonnier; acier, noir

L 1180, B 510, H 350



9 008606 243525



9 002759 980344

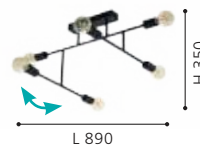

9 002759 980351

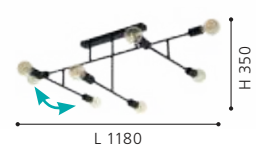



99664



98882

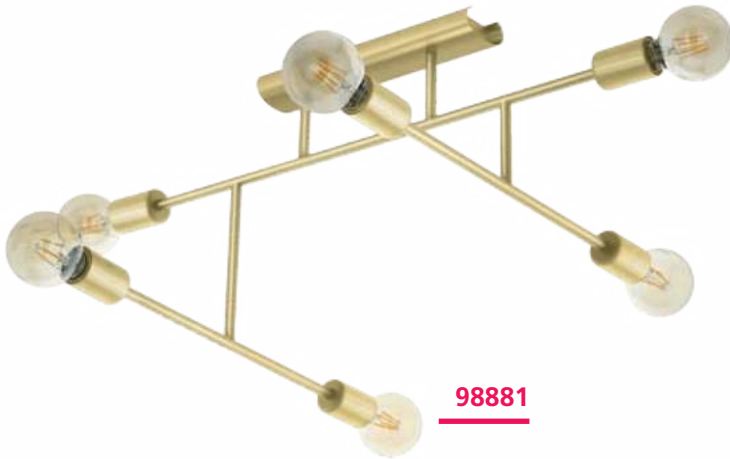

98881



99664 ENCINITOS

ceiling light; steel, black, gold
Deckenleuchte; Stahl, schwarz, gold
plafonnier; acier, noir, or

H 260, Ø 450



E27 1x 40W

98881 BELSIANA 1

ceiling light; steel, brushed brass
Deckenleuchte; Stahl, messing-gebürstet
plafonnier; acier, laiton brossé

L 1155, B 495, H 455



E27 6x 40W

98882 BELSIANA 1

ceiling light; steel, brushed brass
Deckenleuchte; Stahl, messing-gebürstet
plafonnier; acier, laiton brossé

L 1180, B 380, H 350



E27 8x 40W



9 002759 996642



9 002759 988814

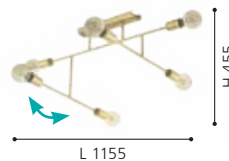

9 002759 988821

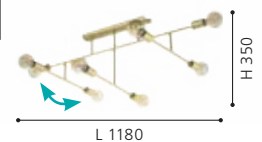



97731

LED



900302



97731 MONTEBALDO

ceiling light; steel, black, gold
Deckenleuchte; Stahl, schwarz, gold
plafonnier; acier, noir, or

L 380, B 380, H 170



GU10



4x 4,5W



warm
WHITE

4x

345lm

900302 BARRANCAS

ceiling light; steel, black, gold / brilliant glass, clear
Deckenleuchte; Stahl, schwarz, gold / Brillantglas, klar
plafonnier; acier, noir, or / verre brillant, transparent

L 380, B 380, H 180



E14



4x 40W



9 002759 977313

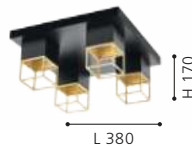

9 008606 242764

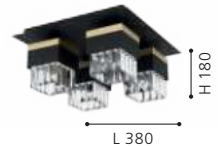



900524



97904



97895

900524 MORDAZO

ceiling light; steel, black / fabric, wood, anthracite-brown, white
 Deckenleuchte; Stahl, schwarz / Textil, Holz, anthrazit-braun, weiss
 plafonnier; acier, noir / textile, bois, marron anthracite, blanc

L 510, B 510, H 175



E27 4x 28W

97904 STAITI

ceiling light; steel, black
 Deckenleuchte; Stahl, schwarz
 plafonnier; acier, noir

H 140, Ø 760



E27 7x 60W

97895 STAITI

ceiling light; steel, black / fabric, black, gold
 Deckenleuchte; Stahl, schwarz / Textil, schwarz, gold
 plafonnier; acier, noir / tissu, noir, or

H 235, Ø 840



E27 7x 40W



9 008606 244522

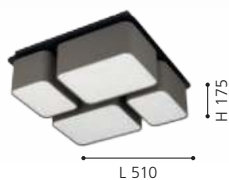

9 002759 979041

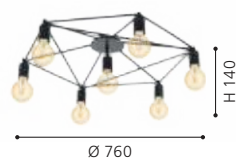

9 002759 978952

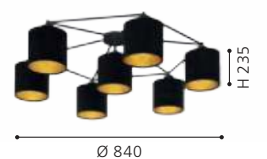



98333



98331



98332

98333 SILENTINA

ceiling light; steel, black
Deckenleuchte; Stahl, schwarz
plafonnier; acier, noir

L 540, B 180, H 205



E27



3x 40W



9 002759 983338

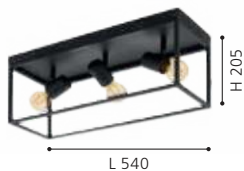

98331 SILENTINA

ceiling light; steel, black
Deckenleuchte; Stahl, schwarz
plafonnier; acier, noir

L 180, B 180, H 205



E27



1x 40W



9 002759 983314

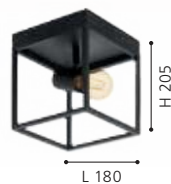

98332 SILENTINA

ceiling light; steel, black
Deckenleuchte; Stahl, schwarz
plafonnier; acier, noir

L 360, B 180, H 205



E27



2x 40W



9 002759 983321





98334



900509

98334 SILENTINA

ceiling light; steel, black
Deckenleuchte; Stahl, schwarz
plafonnier; acier, noir

L 360, B 360, H 205



9 002759 983345

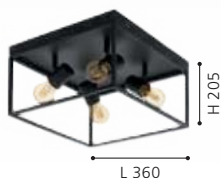

900509 MACCHIONE

wall light; steel, black, brass
Wandleuchte; Stahl, schwarz, messing
applique; acier, noir, laiton

L 500, H 110, A 85



9 008606 244393

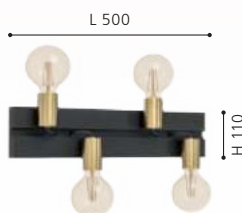

MACCHIONE

Frames can be individually aligned for the customer using a magnet. The luminaire works both as a wall luminaire and as a ceiling luminaire.

Fassungen sind mithilfe eines Magnets für den Kunden individuell ausrichtbar. Die Leuchte funktioniert sowohl als Wandleuchte, als auch als Deckenleuchte.

Les cadres peuvent être alignés individuellement pour le client à l'aide d'un aimant. La luminaire fonctionne à la fois comme applique murale et comme plafonnier.





900357 PIEDRITAS

ceiling light; steel, black
Deckenleuchte; Stahl, schwarz
plafonnier; acier, noir

L 730, B 180, H 205



E27



3x 40W

900356 PIEDRITAS

ceiling light; steel, black
Deckenleuchte; Stahl, schwarz
plafonnier; acier, noir

L 515, B 180, H 205



E27



2x 40W

900355 PIEDRITAS

ceiling light; steel, black
Deckenleuchte; Stahl, schwarz
plafonnier; acier, noir

L 180, B 180, H 205



E27



1x 40W



9 008606 235728

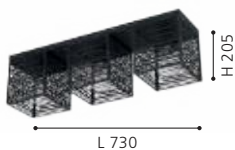

9 008606 235711



9 008606 235704

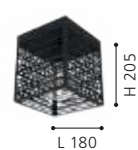



900355





94547



94548



900359

94547 MOGANO

ceiling light; steel, black, copper
Deckenleuchte; Stahl, schwarz, kupfer
plafonnier; acier, noir, cuivre

H 170, Ø 400



94548 MOGANO

ceiling light; steel, white, silver
Deckenleuchte; Stahl, weiss, silber
plafonnier; acier, blanc, argent

H 170, Ø 400

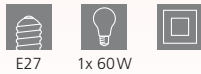

900359 MOGANO

ceiling light; steel, Mokka colour
Deckenleuchte; Stahl, Mokkafarben
plafonnier; acier, café

H 175, Ø 400



9 002759 945473



9 002759 945480



9 008606 235315

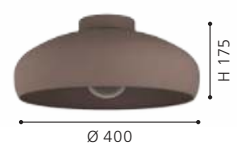



43637

43637 MOGANO

ceiling light; steel, black
Deckenleuchte; Stahl, schwarz
plafonnier; acier, noir

H 170, Ø 400



E27



1x 60W



9 002759 436377





900553



900554



900555

900553 MOGANO 2

ceiling light; steel, black
Deckenleuchte; Stahl, schwarz
plafonnier; acier, noir

H 175, Ø 280



E27 1x 40W

900554 MOGANO 2

ceiling light; steel, black, gold
Deckenleuchte; Stahl, schwarz, gold
plafonnier; acier, noir, or

H 175, Ø 280



E27 1x 40W

900555 MOGANO 2

ceiling light; steel, black, copper
Deckenleuchte; Stahl, schwarz, kupfer
plafonnier; acier, noir, cuivre

H 175, Ø 280



E27 1x 40W



9 008606 244584



9 008606 244591



9 008606 244607





99515



99514



99516



99514 VALCASOTTO

ceiling light; steel, black
Deckenleuchte; Stahl, schwarz
plafonnier; acier, noir

L 110, B 110, H 100

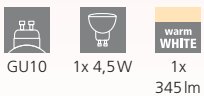

99515 VALCASOTTO

ceiling light; steel, black
Deckenleuchte; Stahl, schwarz
plafonnier; acier, noir

L 570, B 100, H 100

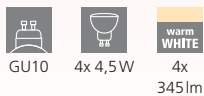

99516 VALCASOTTO

ceiling light; steel, black
Deckenleuchte; Stahl, schwarz
plafonnier; acier, noir

L 320, B 320, H 100

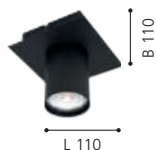
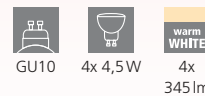



900435



900443



900435 VALCASOTTO 1

ceiling light; steel, wood, black, brown
 Deckenleuchte; Stahl, Holz, schwarz, braun
 plafonnier; acier, bois, noir, marron

L 370, B 370, H 100



GU10



4x 4,5W



4x
 warm
 WHITE
 345lm

900443 TARRAFO

ceiling light; steel, wood, black, brown
 Deckenleuchte; Stahl, Holz, schwarz, braun
 plafonnier; acier, bois, noir, marron

L 640, B 150, H 155



E27



3x 40W





DESIGN
HIGHLIGHT
DETAIL

99667 BASURTU

ceiling light; steel, black
Deckenleuchte; Stahl, schwarz
plafonnier; acier, noir

H 270, Ø 1050



E27



5x 40W



9 002759 996673

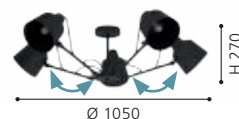



900157



900614

900188 LORETO

ceiling light; steel, black, white
Deckenleuchte; Stahl, schwarz, weiss
plafonnier; acier, noir, blanc

H 355, Ø 1145



E27 3x 25W



9 008606 235629

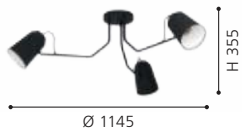

900157 LORETO

wall light; steel, black, white
Wandleuchte; Stahl, schwarz, weiss
applique; acier, noir, blanc

L 670, B 140, H 365



E27 1x 40W



9 008606 235766



900614 LORETO 1

wall light; steel, black, white
Wandleuchte; Stahl, schwarz, weiss
applique; acier, noir, blanc

L 140, H 350, A 1030



E27 1x 28W



9 008606 245116

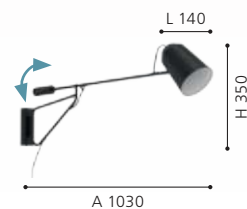



900361





900185



98514



98514

900361 MARIEL

ceiling light; steel, wood, light grey, brown
Deckenleuchte; Stahl, Holz, hellgrau, braun
plafonnier; acier, bois, gris clair, marron

L 910, B 190, H 255



E27 3x 40W

900185 FILAGO

ceiling light; steel, wood, black, brown / glass, black-grey-transparent
Deckenleuchte; Stahl, Holz, schwarz, braun / Glas, schwarz-grau-transparent
plafonnier; acier, bois, noir, marron / verre, noir-gris-transparent

L 880, B 145, H 250



E27 4x 40W

98514 MAROJALES

ceiling light; steel, black / glass vaporized, black-transparent
Deckenleuchte; Stahl, schwarz / Glas bedampft, schwarz-transparent
plafonnier; acier, noir / verre vaporisé, noir transparent

L 555, B 180, H 280



E27 2x 28W



9 008606 239108

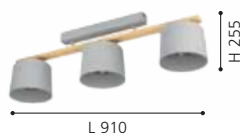

L 910



9 008606 235322



L 880



9 002759 985141



L 555



30933

LED



30931

LED

30933 CABO

ceiling light; stainless steel, chrome / satin glass, white, clear
Deckenleuchte; Edelstahl, chrom / Glas satiniert, weiss, klar
plafonnier; acier inoxydable, chrome / verre satiné, blanc, transparent

H 70, Ø 350



GU10



5x 2,8W



5x
warm
WHITE
250lm

30931 CABO

ceiling light; stainless steel, chrome / satin glass, white, clear
Deckenleuchte; Edelstahl, chrom / Glas satiniert, weiss, klar
plafonnier; acier inoxydable, chrome / verre satiné, blanc, transparent

L 290, B 290, H 70



GU10



4x 2,8W



4x
warm
WHITE
250lm

92727 CONDRA DA 1

ceiling light; steel, chrome / satin glass, white
Deckenleuchte; Stahl, chrom / Glas satiniert, weiss
plafonnier; acier, chrome / verre satiné, blanc

L 470, B 470, H 300



G9



8x 18W



9 002759 309336



9 002759 309312



9 002759 927271

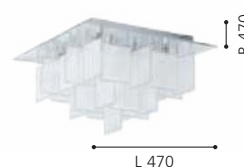



92727





95285



95284



CLEMENTE

95285 CLEMENTE

ceiling light; steel, chrome / brilliant glass, clear
Deckenleuchte; Stahl, chrom / Brillantglas, klar
plafonnier; acier, chrome / verre brillant, transparent

H 205, Ø 450



E27 3x 60W



9 002759 952853

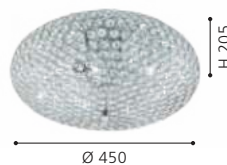

95284 CLEMENTE

ceiling light; steel, chrome / brilliant glass, clear
Deckenleuchte; Stahl, chrom / Brillantglas, klar
plafonnier; acier, chrome / verre brillant, transparent

H 200, Ø 350



E27 2x 60W



9 002759 952846

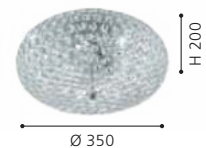



95639



99356



32025



99356 ACOLLA 1

wall / ceiling light; steel, black / glass with brilliant glass, white, clear

Wand- / Deckenleuchte; Stahl, schwarz / Glas mit Brillantglas, weiss, klar

Applique/Plafonnier; acier, noir / verre avec verre brillant, blanc, transparent

H 85, Ø 290



11W 1300lm

95639 ACOLLA

wall / ceiling light; steel, chrome / glass with brilliant glass, white, clear

Wand- / Deckenleuchte; Stahl, chrom / Glas mit Brillantglas, weiss, klar

Applique/Plafonnier; acier, chrome / verre avec verre brillant, blanc, transparent

H 85, Ø 290



3x 11W 3x 950lm

32025 CARDITO

ceiling light; steel, chrome / glass, brilliant glass, clear

Deckenleuchte; Stahl, chrom / Glas, Brillantglas, klar

plafonnier; acier, chrome / verre, verre brillant, transparent

L 320, B 320, H 55



16W 2500lm



9 002759 993566



9 002759 956394



9 002759 320256





99324



99325



99328



99324 FRADELO 1

wall / ceiling light; steel, black / plastic, brilliant glass, black, clear

Wand- / Deckenleuchte; Stahl, schwarz / Kunststoff, Brillantglas, schwarz, klar

Applique/Plafonnier; acier, noir / plastique, verre brillant, noir, transparent

L 140, B 140, H 60



1x 3,2W 400lm

99325 FRADELO 1

wall / ceiling light; steel, black / plastic, brilliant glass, black, clear

Wand- / Deckenleuchte; Stahl, schwarz / Kunststoff, Brillantglas, schwarz, klar

Applique/Plafonnier; acier, noir / plastique, verre brillant, noir, transparent

L 460, B 140, H 60



3x 3,5W 1200lm

99328 FRADELO 1

ceiling light; steel, black / plastic, brilliant glass, black, clear

Deckenleuchte; Stahl, schwarz / Kunststoff, Brillantglas, schwarz, klar

plafonnier; acier, noir / plastique, verre brillant, noir, transparent

L 520, B 520, H 95



46,5W 5500lm



9 002759 993245

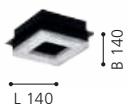

9 002759 993252



9 002759 993283





99327

LED



99326

LED



99327 FRADELO 1

ceiling light; steel, black / plastic, brilliant glass, black, clear
 Deckenleuchte; Stahl, schwarz / Kunststoff, Brillantglas, schwarz, klar
 plafonnier; acier, noir / plastique, verre brillant, noir, transparent

L 260, B 260, H 85



4x 2W 920lm 1x 3,5W 400lm



9 002759 993276



99326 FRADELO 1

wall / ceiling light; steel, black / plastic, brilliant glass, black, clear
 Wand- / Deckenleuchte; Stahl, schwarz / Kunststoff, Brillantglas, schwarz, klar
 Applique/Plafonnier; acier, noir / plastique, verre brillant, noir, transparent

L 280, B 280, H 60



4x 3,5W 1600lm



9 002759 993269

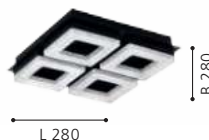

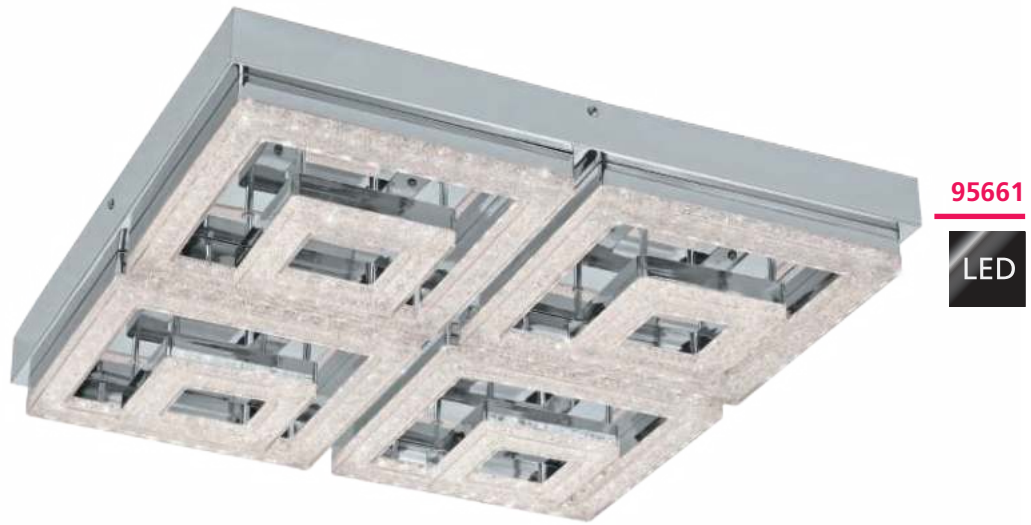

95655 FRADELO

wall / ceiling light; steel, chrome / plastic, brilliant glass, chrome, clear

Wand- / Deckenleuchte; Stahl, chrom / Kunststoff, Brillantglas, chrom, klar

Applique/Plafonnier; acier, chrome / plastique, verre brillant, chrome, transparent

L 140, B 140, H 60



1x 3,2W 400lm

95656 FRADELO

wall / ceiling light; steel, chrome / plastic, brilliant glass, chrome, clear

Wand- / Deckenleuchte; Stahl, chrom / Kunststoff, Brillantglas, chrom, klar

Applique/Plafonnier; acier, chrome / plastique, verre brillant, chrome, transparent

L 460, B 140, H 60



3x 3,5W 1200lm

95661 FRADELO

ceiling light; steel, chrome / plastic, brilliant glass, chrome, clear

Deckenleuchte; Stahl, chrom / Kunststoff, Brillantglas, chrom, klar

plafonnier; acier, chrome / plastique, verre brillant, chrome, transparent

L 520, B 520, H 95



46,5W 5500lm



9 002759 956554

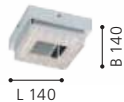

9 002759 956561



9 002759 956615





95657

LED



95659

LED



95658

LED



95657 FRADELO

wall / ceiling light; steel, chrome / plastic, brilliant glass, chrome, clear

Wand- / Deckenleuchte; Stahl, chrom / Kunststoff, Brillantglas, chrom, klar

Applique/Plafonnier; acier, chrome / plastique, verre brillant, chrome, transparent

L 280, B 280, H 60



4x 3,5W 1600lm

95659 FRADELO

ceiling light; steel, chrome / plastic, brilliant glass, chrome, clear

Deckenleuchte; Stahl, chrom / Kunststoff, Brillantglas, chrom, klar

plafonnier; acier, chrome / plastique, verre brillant, chrome, transparent

L 260, B 260, H 85



4x 2W 920lm 1x 3,5W 400lm



95658 FRADELO

wall / ceiling light; steel, chrome / plastic, brilliant glass, chrome, clear

Wand- / Deckenleuchte; Stahl, chrom / Kunststoff, Brillantglas, chrom, klar

Applique/Plafonnier; acier, chrome / plastique, verre brillant, chrome, transparent

L 440, B 440, H 70



9x 3,8W 3780lm



9 002759 956578



9 002759 956592



9 002759 956585





95664

LED



95662

LED



DESIGN
HIGHLIGHT
DETAIL

95664 FRADELO

wall / ceiling light; steel, chrome / plastic, brilliant glass, chrome, clear

Wand- / Deckenleuchte; Stahl, chrom / Kunststoff, Brillantglas, chrom, klar

Applique/Plafonnier; acier, chrome / plastique, verre brillant, chrome, transparent

L 280, B 280, H 60



4x 3,5W



1600lm



95662 FRADELO

wall / ceiling light; steel, chrome / plastic, brilliant glass, chrome, clear

Wand- / Deckenleuchte; Stahl, chrom / Kunststoff, Brillantglas, chrom, klar

Applique/Plafonnier; acier, chrome / plastique, verre brillant, chrome, transparent

L 140, B 140, H 60



1x 3,2W



400lm



9 002759 956646



9 002759 956622





95689

LED



VALLEMARE

These luminaires come with high quality brilliant glass.

Diese Leuchten sind mit hochwertigem Brillantglas ausgestattet.

Ces lumières sont fabriquées avec une haute qualité Equipé de verre brillant.



97487

LED



95689 SORRENTA 1

wall / ceiling light; steel, white / glass with brilliant glass, white, clear

Wand- / Deckenleuchte; Stahl, weiss / Glas mit Brillantglas, weiss, klar

Applique/Plafonnier; acier, blanc / verre avec verre brillant, blanc, transparent

H 95, Ø 315

LED

neutral
WHITE



3x 3,8W 1170lm

97487 VALLEMARE

wall / ceiling light; aluminium, steel, chrome / plastic, brilliant glass, white, clear

Wand- / Deckenleuchte; Alu, Stahl, chrom / Kunststoff, Brillantglas, weiss, klar

Applique/Plafonnier; aluminium, acier, chrome / plastique, verre brillant, blanc, transparent

H 125, Ø 650

LED

warm
WHITE



5x 6,6W 4500lm



9 002759 956899



9 002759 974879



SORRENTA 1

These luminaires come with high quality brilliant glass.

Diese Leuchten sind mit hochwertigem Brillantglas ausgestattet.

Ces lumières sont fabriquées avec une haute qualité Equipé de verre brillant.



98527

LED

incl./inkl./inclus



 TUNABLE WHITE	 STEP DIMMING	 NIGHT LIGHT FUNCTION	98527 <hr/> 98685
1. warmwhite (2700K/100%) 2. neutralwhite 3850K (2700K/50% + 5000K/50%) 3. coldwhite (5000K/100%)			



98685

LED

incl./inkl./inclus



98527 CANICOSA 2

wall / ceiling light; plastic, steel, black, gold / plastic with granille, transparent

Wand- / Deckenleuchte; Kunststoff, Stahl, schwarz, gold / Kunststoff mit Granille, transparent

applique / plafonnier; plastique, acier, noir, or / plastique granité, transparent

H 90, Ø 495

				
24,5W	3200lm		Remote	

98685 CANICOSA 2

wall / ceiling light; plastic, steel, black, gold / plastic with granille, transparent

Wand- / Deckenleuchte; Kunststoff, Stahl, schwarz, gold / Kunststoff mit Granille, transparent

applique / plafonnier; plastique, acier, noir, or / plastique granité, transparent

H 145, Ø 765

				
4x 4,5W	2120lm		Remote	



9 002759 985271

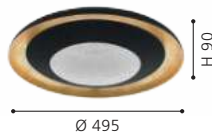

9 002759 986858

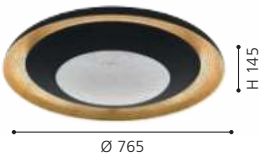



98487

LED



98023

LED



98488

LED

98023 MONTENOVO

wall / ceiling light; steel, white / glass, white, gold
Wand- / Deckenleuchte; Stahl, weiss / Glas, weiss, gold
applique / plafonnier; acier, blanc / verre, blanc, or

H 100, Ø 395



3x 7,3W 2220lm

98487 POZONDON

ceiling light; steel, gold-coloured / plastic, white
Deckenleuchte; Stahl, goldfarben / Kunststoff, weiss
plafonnier; acier, or / plastique, blanc

H 100, Ø 380



18W 2300lm

98488 POZONDON

ceiling light; steel, gold-coloured / plastic, white
Deckenleuchte; Stahl, goldfarben / Kunststoff, weiss
plafonnier; acier, or / plastique, blanc

H 120, Ø 520



22,5W 3100lm



9 002759 980238



9 002759 984878

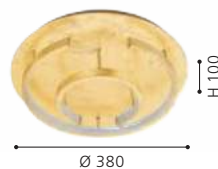

9 002759 984885

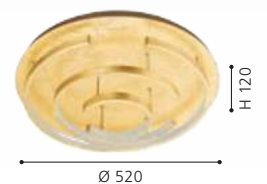



97526



incl./inkl./inclus



97527



incl./inkl./inclus



97528



incl./inkl./inclus



				<u>97526</u>	<u>97541</u>
TUNABLE WHITE	DIMMABLE	TIMER FUNCTION	NIGHT LIGHT FUNCTION	<u>97527</u>	<u>97542</u>
3000 - 5000 K	10 - 100 %	off after 30sec.		<u>97528</u>	<u>97543</u>

97526 GIRON

ceiling light; steel, white / plastic, white
Deckenleuchte; Stahl, weiss / Kunststoff, weiss
plafonnier; acier, blanc / plastique, blanc

H 75, Ø 570



36W



4300lm



Remote

97527 GIRON

ceiling light; steel, white / plastic, white
Deckenleuchte; Stahl, weiss / Kunststoff, weiss
plafonnier; acier, blanc / plastique, blanc

H 85, Ø 760



54,5W



6500lm



Remote

97528 GIRON

ceiling light; steel, white / plastic, white
Deckenleuchte; Stahl, weiss / Kunststoff, weiss
plafonnier; acier, blanc / plastique, blanc

H 120, Ø 1000



73W



9800lm



Remote



9 002759 975265

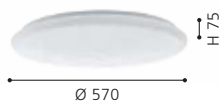

9 002759 975272



9 002759 975289





97541



incl./inkl./inclus



97542



incl./inkl./inclus



97543



incl./inkl./inclus



97541 GIRON-S

ceiling light; steel, white / plastic with crystal effect, white
Deckenleuchte; Stahl, weiss / Kunststoff m.Kristalleffekt, weiss
plafonnier; acier, blanc / plastique avec effet cristal, blanc

H 75, Ø 570



36W



4300lm



Remote

97542 GIRON-S

ceiling light; steel, white / plastic with crystal effect, white
Deckenleuchte; Stahl, weiss / Kunststoff m.Kristalleffekt, weiss
plafonnier; acier, blanc / plastique avec effet cristal, blanc

H 85, Ø 760



54,5W



6500lm



Remote

97543 GIRON-S

ceiling light; steel, white / plastic with crystal effect, white
Deckenleuchte; Stahl, weiss / Kunststoff m.Kristalleffekt, weiss
plafonnier; acier, blanc / plastique avec effet cristal, blanc

H 120, Ø 1000



73W



9800lm



Remote



9 002759 975418



Ø 570



9 002759 975425



Ø 760



9 002759 975432

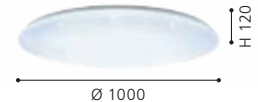

Ø 1000



97871

LED



97872

LED



97873

LED

97871 FRANIA

wall / ceiling light; steel, white / plastic, white
Wand- / Deckenleuchte; Stahl, weiss / Kunststoff, weiss
applique / plafonnier; acier, blanc / plastique, blanc

H 70, Ø 280

LED

warm
WHITE



10W

1100lm

97872 FRANIA

wall / ceiling light; steel, white / plastic, white
Wand- / Deckenleuchte; Stahl, weiss / Kunststoff, weiss
applique / plafonnier; acier, blanc / plastique, blanc

H 70, Ø 330

LED

warm
WHITE



14,6W

1600lm

97873 FRANIA

wall / ceiling light; steel, white / plastic, white
Wand- / Deckenleuchte; Stahl, weiss / Kunststoff, weiss
applique / plafonnier; acier, blanc / plastique, blanc

H 70, Ø 430

LED

warm
WHITE



6x 5,5W

3600lm



9 002759 978716

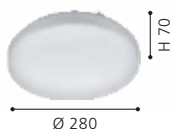

9 002759 978723



9 002759 978730





98446



98446 FRANIA

wall / ceiling light; steel, white / plastic, white
Wand- / Deckenleuchte; Stahl, weiss / Kunststoff, weiss
applique / plafonnier; acier, blanc / plastique, blanc

H 70, Ø 550

LED

50W

warm
WHITE

5900lm



9 002759 984465





97877



97878



97879



97877 FRANIA-S

wall / ceiling light; steel, white / plastic with crystal effect, white
Wand- / Deckenleuchte; Stahl, weiss / Kunststoff m.Kristalleffekt, weiss
applique / plafonnier; acier, blanc / plastique avec effet cristal, blanc

H 70, Ø 280



10W



1100lm



97878 FRANIA-S

wall / ceiling light; steel, white / plastic with crystal effect, white
Wand- / Deckenleuchte; Stahl, weiss / Kunststoff m.Kristalleffekt, weiss
applique / plafonnier; acier, blanc / plastique avec effet cristal, blanc

H 70, Ø 330



14,6W



1600lm



97879 FRANIA-S

wall / ceiling light; steel, white / plastic with crystal effect, white
Wand- / Deckenleuchte; Stahl, weiss / Kunststoff m.Kristalleffekt, weiss
applique / plafonnier; acier, blanc / plastique avec effet cristal, blanc

H 70, Ø 430



6x 5,5W



3600lm



9 002759 978778

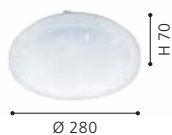

9 002759 978785



9 002759 978792





98448



98448 FRANIA-S

wall / ceiling light; steel, white / plastic with crystal effect, white
Wand- / Deckenleuchte; Stahl, weiss / Kunststoff m. Kristalleffekt, weiss
applique / plafonnier; acier, blanc / plastique avec effet cristal, blanc

H 70, Ø 550



50W 5900lm

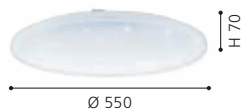



97874



97875



97876



97874 FRANIA

wall / ceiling light; steel, white / plastic, white
Wand- / Deckenleuchte; Stahl, weiss / Kunststoff, weiss
applique / plafonnier; acier, blanc / plastique, blanc

L 280, B 280, H 70



warm
WHITE
1100lm



9 002759 978747

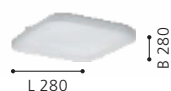

97875 FRANIA

wall / ceiling light; steel, white / plastic, white
Wand- / Deckenleuchte; Stahl, weiss / Kunststoff, weiss
applique / plafonnier; acier, blanc / plastique, blanc

L 330, B 330, H 70



warm
WHITE
1600lm



9 002759 978754

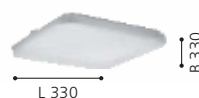

97876 FRANIA

wall / ceiling light; steel, white / plastic, white
Wand- / Deckenleuchte; Stahl, weiss / Kunststoff, weiss
applique / plafonnier; acier, blanc / plastique, blanc

L 430, B 430, H 70



warm
WHITE
3600lm



9 002759 978761

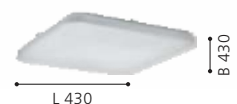



98447

LED

98447 FRANIA

wall / ceiling light; steel, white / plastic, white
Wand- / Deckenleuchte; Stahl, weiss / Kunststoff, weiss
applique / plafonnier; acier, blanc / plastique, blanc

L 530, B 530, H 70





97881



97882



97883



97881 FRANIA-S

wall / ceiling light; steel, white / plastic with crystal effect, white
Wand- / Deckenleuchte; Stahl, weiss / Kunststoff m.Kristalleffekt, weiss
applique / plafonnier; acier, blanc / plastique avec effet cristal, blanc

L 280, B 280, H 70

LED

warm
WHITE



10W

1100lm

97882 FRANIA-S

wall / ceiling light; steel, white / plastic with crystal effect, white
Wand- / Deckenleuchte; Stahl, weiss / Kunststoff m.Kristalleffekt, weiss
applique / plafonnier; acier, blanc / plastique avec effet cristal, blanc

L 330, B 330, H 70

LED

warm
WHITE



14,6W

1600lm

97883 FRANIA-S

wall / ceiling light; steel, white / plastic with crystal effect, white
Wand- / Deckenleuchte; Stahl, weiss / Kunststoff m.Kristalleffekt, weiss
applique / plafonnier; acier, blanc / plastique avec effet cristal, blanc

L 430, B 430, H 70

LED

warm
WHITE



6x 5,5W

3600lm



9 002759 978815

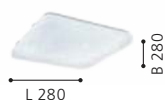

9 002759 978822



9 002759 978839





98449

LED

98449 FRANIA-S

wall / ceiling light; steel, white / plastic with crystal effect, white

Wand- / Deckenleuchte; Stahl, weiss / Kunststoff m. Kristalleffekt, weiss

applique / plafonnier; acier, blanc / plastique avec effet cristal, blanc

L 530, B 530, H 70

LED

50W

warm
WHITE

5900lm



9 002759 984496





99341

LED

incl./inkl./inclus



99342

LED

incl./inkl./inclus



97577

LED

incl./inkl./inclus



TUNABLE
WHITE

2700 - 6500 K



STEP
DIMMING

10/25/50/100 %

97577

97578



99341 ZAMUDILO

ceiling light; steel, white / plastic with crystal effect, white, silver
Deckenleuchte; Stahl, weiss / Kunststoff m. Kristalleffekt, weiss, silber
plafonnier; acier, blanc / plastique avec effet cristal, blanc, argent

H 90, Ø 400



16,5W



1850lm



Remote

99342 ZAMUDILO

ceiling light; steel, white / plastic with crystal effect, white, silver
Deckenleuchte; Stahl, weiss / Kunststoff m. Kristalleffekt, weiss, silber
plafonnier; acier, blanc / plastique avec effet cristal, blanc, argent

H 90, Ø 500



21,6W



2450lm



Remote

97577 SILERAS

wall / ceiling light; steel, white / plastic with crystal effect, white
Wand- / Deckenleuchte; Stahl, weiss / Kunststoff m. Kristalleffekt, weiss
applique / plafonnier; acier, blanc / plastique avec effet cristal, blanc

H 85, Ø 450



22,5W



2800lm



Remote



9 002759 993412

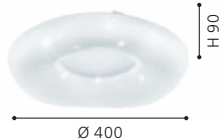

9 002759 993429



9 002759 975777





97578



99108



99109



97578 SILERAS

wall / ceiling light; steel, white / plastic with crystal effect, white
Wand- / Deckenleuchte; Stahl, weiss / Kunststoff m. Kristalleffekt, weiss
applique / plafonnier; acier, blanc / plastique avec effet cristal, blanc

H 85, Ø 600



35W 4400lm

Remote

99108 RUIDERA

ceiling light; steel, white / plastic, white, silver
Deckenleuchte; Stahl, weiss / Kunststoff, weiss, silber
plafonnier; acier, blanc / plastique, blanc, argent

H 90, Ø 480



22W 2500lm

99109 RUIDERA

ceiling light; steel, white / plastic, white, silver
Deckenleuchte; Stahl, weiss / Kunststoff, weiss, silber
plafonnier; acier, blanc / plastique, blanc, argent

L 480, B 480, H 90



22W 2500lm





2700 K
4500 K
6500 K

95972

95973



96026



VOLTAGO 2

These luminaires come with an interesting glitter-effect.

Diese Leuchten sind mit einem interessanten Glitzer-Effekt ausgestattet.

Ces luminaires viennent avec un effet scintillant intéressant.



95972



incl./inkl./inclus



96026 CAPASSO 1

wall / ceiling light; steel, white / plastic, white, chrome
Wand- / Deckenleuchte; Stahl, weiss / Kunststoff, weiss, chrom
applique / plafonnier; acier, blanc / plastique, blanc, chrome

H 70, Ø 400



20W



2400lm



95972 VOLTAGO 2

wall / ceiling light; steel, white / plastic with crystal effect, white
Wand- / Deckenleuchte; Stahl, weiss / Kunststoff m. Kristalleffekt, weiss
applique / plafonnier; acier, blanc / plastique avec effet cristal, blanc

H 105, Ø 380



4x 4,8W



1920lm



Remote



95973 VOLTAGO 2

wall / ceiling light; steel, white / plastic with crystal effect, white
Wand- / Deckenleuchte; Stahl, weiss / Kunststoff m. Kristalleffekt, weiss
applique / plafonnier; acier, blanc / plastique avec effet cristal, blanc

H 125, Ø 580



4x 8,2W



3800lm



Remote



9 002759 960261



9 002759 959722



9 002759 959739





95973

LED

incl./inkl./inclus





97738

LED

incl./inkl./inclus



98323

LED

incl./inkl./inclus



98324

LED

incl./inkl./inclus



98323

98324

97737

97738

10 - 100 %

off after 30sec.

97738 LANCIANO

ceiling light; steel, white, transparent / plastic with crystal effect, white, silver

Deckenleuchte; Stahl, weiss, transparent / Kunststoff m.Kristalleffekt, weiss, silber

plafonnier; acier, blanc, transparent / plastique avec effet cristal, blanc, argent

H 105, Ø 860



56W



6800lm



Remote

98323 LANCIANO 1

wall / ceiling light; steel, white, transparent / plastic with crystal effect, white, chrome

Wand- / Deckenleuchte; Stahl, weiss, transparent / Kunststoff m.Kristalleffekt, weiss, chrom

applique / plafonnier; acier, blanc, transparent / plastique avec effet cristal, blanc, chrome

H 75, Ø 400



24W



1900lm



Remote

98324 LANCIANO 1

wall / ceiling light; steel, white, transparent / plastic with crystal effect, white, chrome

Wand- / Deckenleuchte; Stahl, weiss, transparent / Kunststoff m.Kristalleffekt, weiss, chrom

applique / plafonnier; acier, blanc, transparent / plastique avec effet cristal, blanc, chrome

H 80, Ø 560



33W



4000lm



Remote



9 002759 977382



9 002759 983239

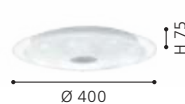

9 002759 983246





97737



incl./inkl./inclus



900598



incl./inkl./inclus



900599



incl./inkl./inclus

97737 LANCIANO

ceiling light; steel, plastic, white, transparent / plastic with crystal effect, white, silver
 Deckenleuchte; Stahl, Kunststoff, weiss, transparent / Kunststoff m. Kristalleffekt, weiss, silber
 plafonnier; acier, plastique, blanc, transparent / plastique avec effet cristal, blanc, argent
 H 100, Ø 660



900598 LANCIANO 1

ceiling light; steel, wood, white, brown / plastic, white
 Deckenleuchte; Stahl, Holz, weiss, braun / Kunststoff, weiss
 plafonnier; acier, bois, blanc, marron / plastique, blanc
 H 70, Ø 380



900599 LANCIANO 1

ceiling light; steel, wood, white, brown / plastic, white
 Deckenleuchte; Stahl, Holz, weiss, braun / Kunststoff, weiss
 plafonnier; acier, bois, blanc, marron / plastique, blanc
 H 80, Ø 480



9 002759 977375



9 008606 244973

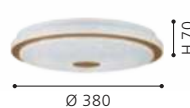

9 008606 244980

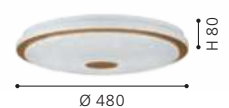



900608

LED



900607

LED

900608 FERENTINO

ceiling light; steel, white / plastic, white
 Deckenleuchte; Stahl, weiss / Kunststoff, weiss
 plafonnier; acier, blanc / plastique, blanc

H 60, Ø 380



19,5W 2300lm

900607 FERENTINO

ceiling light; steel, white / plastic, white
 Deckenleuchte; Stahl, weiss / Kunststoff, weiss
 plafonnier; acier, blanc / plastique, blanc

H 60, Ø 280



10W 1100lm



9 008606 245062

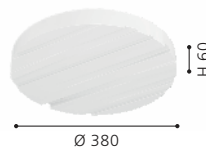

9 008606 245055

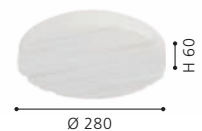



900609



900611



900609 FERENTINO

ceiling light; steel, white / plastic, white
Deckenleuchte; Stahl, weiss / Kunststoff, weiss
plafonnier; acier, blanc / plastique, blanc

L 280, B 280, H 60



10W 1100lm



9 008606 245079



900611 FERENTINO

ceiling light; steel, white / plastic, white
Deckenleuchte; Stahl, weiss / Kunststoff, weiss
plafonnier; acier, blanc / plastique, blanc

L 330, B 330, H 60



14,6W 1600lm



9 008606 245086





900605

LED

incl./inkl./inclus



900606

LED

incl./inkl./inclus



900605 BATTISTONA

ceiling light; steel, white / plastic, white
 Deckenleuchte; Stahl, weiss / Kunststoff, weiss
 plafonnier; acier, blanc / plastique, blanc

H 85, Ø 380



4x 2,9W



1280lm



4x 1,45



Remote

900606 BATTISTONA

ceiling light; steel, white / plastic, white
 Deckenleuchte; Stahl, weiss / Kunststoff, weiss
 plafonnier; acier, blanc / plastique, blanc

H 100, Ø 480



20,8W



2500lm



Remote



9 008606 245031



9 008606 245048

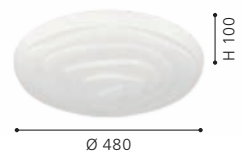



99343

LED



99465

LED



99344

LED

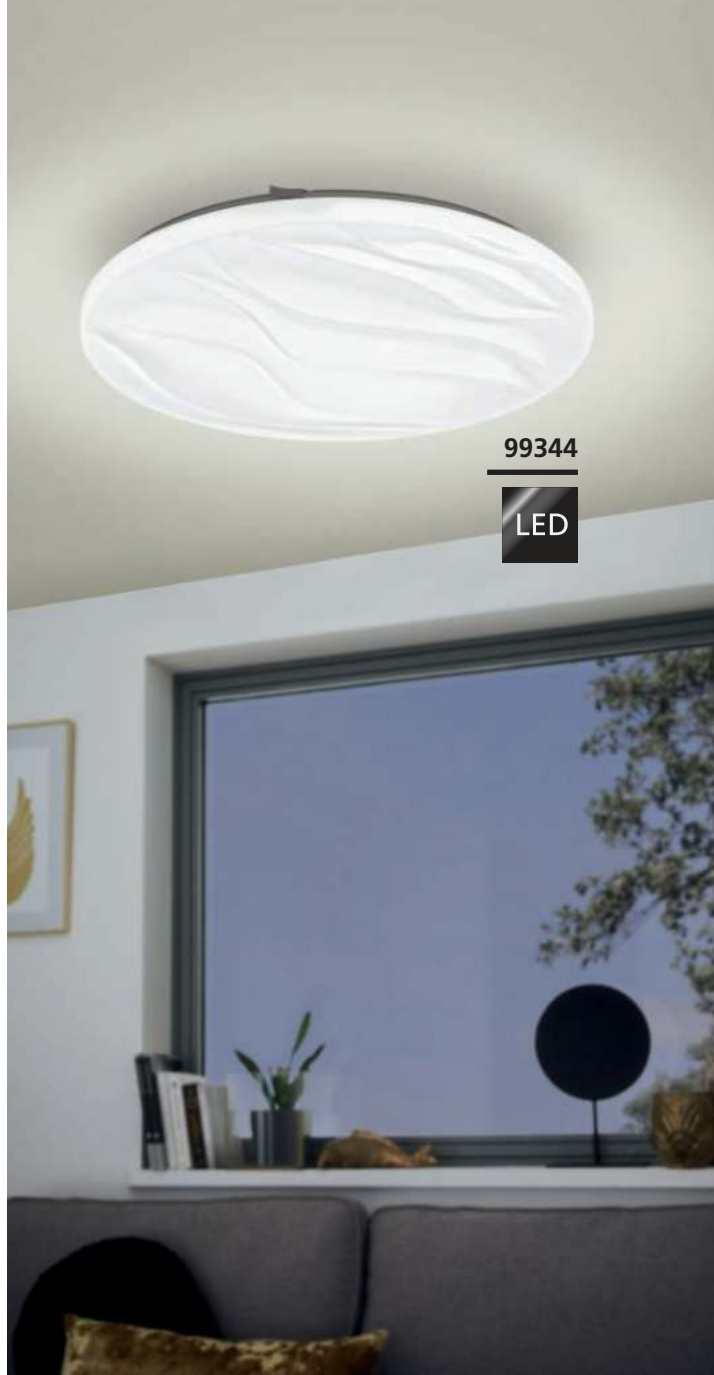

99343 BENARIBA

wall / ceiling light; steel, white / plastic, white
Wand- / Deckenleuchte; Stahl, weiss / Kunststoff, weiss
applique / plafonnier; acier, blanc / plastique, blanc

H 65, Ø 330



14,6W 1600lm

99465 BENARIBA

wall / ceiling light; steel, white / plastic, white
Wand- / Deckenleuchte; Stahl, weiss / Kunststoff, weiss
applique / plafonnier; acier, blanc / plastique, blanc

H 70, Ø 550



8x 4,4W 4240lm

99344 BENARIBA

wall / ceiling light; steel, white / plastic, white
Wand- / Deckenleuchte; Stahl, weiss / Kunststoff, weiss
applique / plafonnier; acier, blanc / plastique, blanc

H 70, Ø 440



22W 2500lm



9 002759 993436



9 002759 994655



9 002759 993443





95677

LED





95679



95677 COMPETA 1

wall / ceiling light; steel, white / plastic, white, silver, clear
 Wand- / Deckenleuchte; Stahl, weiss / Kunststoff, weiss, silber, klar
 applique / plafonnier; acier, blanc / plastique, blanc, argent, transparent

H 75, Ø 335



15,6W 1900lm

95679 COMPETA 1

wall / ceiling light; steel, white / plastic, white, silver, clear
 Wand- / Deckenleuchte; Stahl, weiss / Kunststoff, weiss, silber, klar
 applique / plafonnier; acier, blanc / plastique, blanc, argent, transparent

L 340, B 340, H 80



21W 2400lm





96032



96033



96034



96032 COMPETA 1

wall / ceiling light; steel, white / plastic, white, satined nickel
Wand- / Deckenleuchte; Stahl, weiss / Kunststoff, weiss, nickel-
matt
applique / plafonnier; acier, blanc / plastique, blanc, nickel mat

H 55, Ø 245



15,6W 1900lm



96033 COMPETA 1

wall / ceiling light; steel, white / plastic, white, satined nickel
Wand- / Deckenleuchte; Stahl, weiss / Kunststoff, weiss, nickel-
matt
applique / plafonnier; acier, blanc / plastique, blanc, nickel mat

H 55, Ø 325



18W 2200lm



96034 COMPETA 1

wall / ceiling light; steel, white / plastic, white, satined nickel
Wand- / Deckenleuchte; Stahl, weiss / Kunststoff, weiss, nickel-
matt
applique / plafonnier; acier, blanc / plastique, blanc, nickel mat

H 55, Ø 430



20W 2400lm



9 002759 960322



9 002759 960339



9 002759 960346





95682



95684



95682 PALERMO 2

wall / ceiling light; steel, white / plastic, white, chrome
Wand- / Deckenleuchte; Stahl, weiss / Kunststoff, weiss, chrom
applique / plafonnier; acier, blanc / plastique, blanc, chrome

H 70, Ø 280



15,6W 1900lm

95684 PALERMO 2

wall / ceiling light; steel, white / plastic, white, chrome
Wand- / Deckenleuchte; Stahl, weiss / Kunststoff, weiss, chrom
applique / plafonnier; acier, blanc / plastique, blanc, chrome

H 60, Ø 410



20W 2400lm



9 002759 956820



9 002759 956844





96023 CAPASSO

wall / ceiling light; steel, white / plastic, white, chrome
Wand- / Deckenleuchte; Stahl, weiss / Kunststoff, weiss, chrom
applique / plafonnier; acier, blanc / plastique, blanc, chrome

H 65, Ø 340



900149 CAPASSO

wall / ceiling light; steel, white / plastic, white, black
Wand- / Deckenleuchte; Stahl, weiss / Kunststoff, weiss, schwarz
applique / plafonnier; acier, blanc / plastique, blanc, noir

H 60, Ø 340



900335 CAPASSO

wall / ceiling light; steel, white / plastic, white, black
Wand- / Deckenleuchte; Stahl, weiss / Kunststoff, weiss, schwarz
applique / plafonnier; acier, blanc / plastique, blanc, noir

H 60, Ø 480

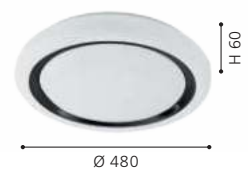



900612



900613



900612 RENDE

ceiling light; steel, white / plastic, white, gold
Deckenleuchte; Stahl, weiss / Kunststoff, weiss, gold
plafonnier; acier, blanc / plastique, blanc, or

H 60, Ø 380



19,5W 2300lm

900613 RENDE

ceiling light; steel, white / plastic, white, silver
Deckenleuchte; Stahl, weiss / Kunststoff, weiss, silber
plafonnier; acier, blanc / plastique, blanc, argent

L 380, B 380, H 60



19,5W 2300lm



9 008606 245093



9 008606 245109





900498

LED



900499

LED



900501

LED



900498 NIEVES 1

wall / ceiling light; steel, white / plastic, white, gold
Wand- / Deckenleuchte; Stahl, weiss / Kunststoff, weiss, gold
applique / plafonnier; acier, blanc / plastique, blanc, or

H 60, Ø 310

LED

warm
WHITE
1100lm



10W

900499 NIEVES 1

wall / ceiling light; steel, white / plastic, white, gold
Wand- / Deckenleuchte; Stahl, weiss / Kunststoff, weiss, gold
applique / plafonnier; acier, blanc / plastique, blanc, or

H 65, Ø 410

LED

warm
WHITE
2300lm



19,5W

2300lm

900501 NIEVES 1

wall / ceiling light; steel, white / plastic, white, gold
Wand- / Deckenleuchte; Stahl, weiss / Kunststoff, weiss, gold
applique / plafonnier; acier, blanc / plastique, blanc, or

H 70, Ø 510

LED

warm
WHITE
3710lm



7x 4,4W

3710lm



9 008606 239634

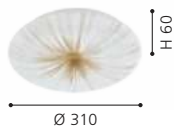

9 008606 239641

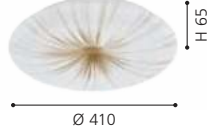

9 008606 239658

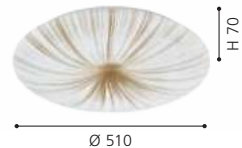



99699

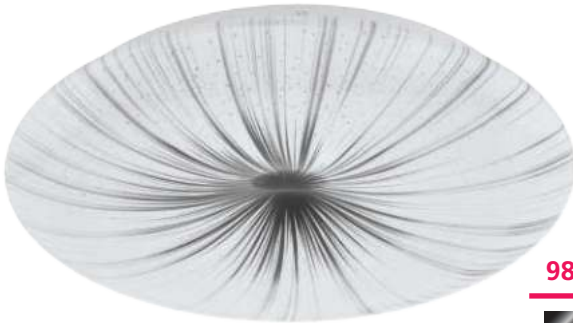

98325

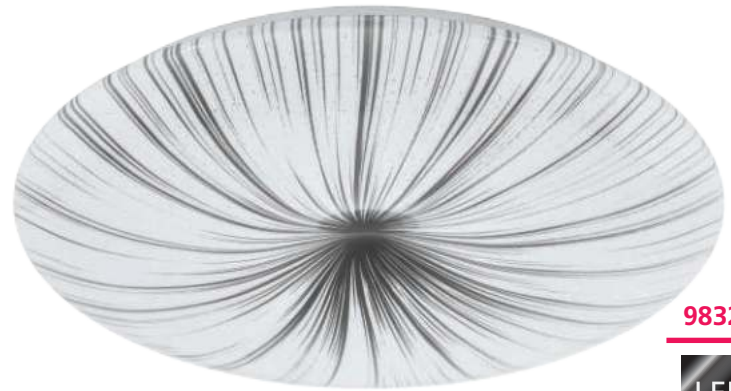

98326



99699 NIEVES

wall / ceiling light; steel, white / plastic, white, silver
Wand- / Deckenleuchte; Stahl, weiss / Kunststoff, weiss, silber
applique / plafonnier; acier, blanc / plastique, blanc, argent

H 60, Ø 310



10W 1100lm

98325 NIEVES

wall / ceiling light; steel, white / plastic, white, silver
Wand- / Deckenleuchte; Stahl, weiss / Kunststoff, weiss, silber
applique / plafonnier; acier, blanc / plastique, blanc, argent

H 65, Ø 410



19,5W 2300lm

98326 NIEVES

wall / ceiling light; steel, white / plastic, white, silver
Wand- / Deckenleuchte; Stahl, weiss / Kunststoff, weiss, silber
applique / plafonnier; acier, blanc / plastique, blanc, argent

H 70, Ø 510



7x 4,4W 3710lm



9 002759 996994

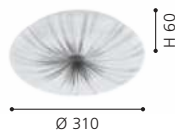

9 002759 983253

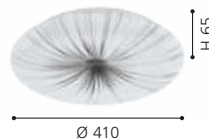

9 002759 983260

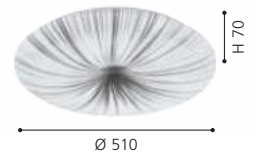



99406



99407



98603



99406 PESCAITO

wall / ceiling light; steel, black / plastic, white, gold
Wand- / Deckenleuchte; Stahl, schwarz / Kunststoff, weiss, gold
applique / plafonnier; acier, noir / plastique, blanc, or

H 65, Ø 280



10W 1100lm

99407 PESCAITO

wall / ceiling light; steel, black / plastic, white, gold
Wand- / Deckenleuchte; Stahl, schwarz / Kunststoff, weiss, gold
applique / plafonnier; acier, noir / plastique, blanc, or

H 65, Ø 380



19,5W 2300lm

98603 MUSURITA

ceiling light; plastic, steel, black / plastic, white
Deckenleuchte; Kunststoff, Stahl, schwarz / Kunststoff, weiss
plafonnier; plastique, acier, noir / plastique, blanc

H 60, Ø 340



14,6W 1600lm



9 002759 994068



9 002759 994075



9 002759 986032





98604



98602



98601

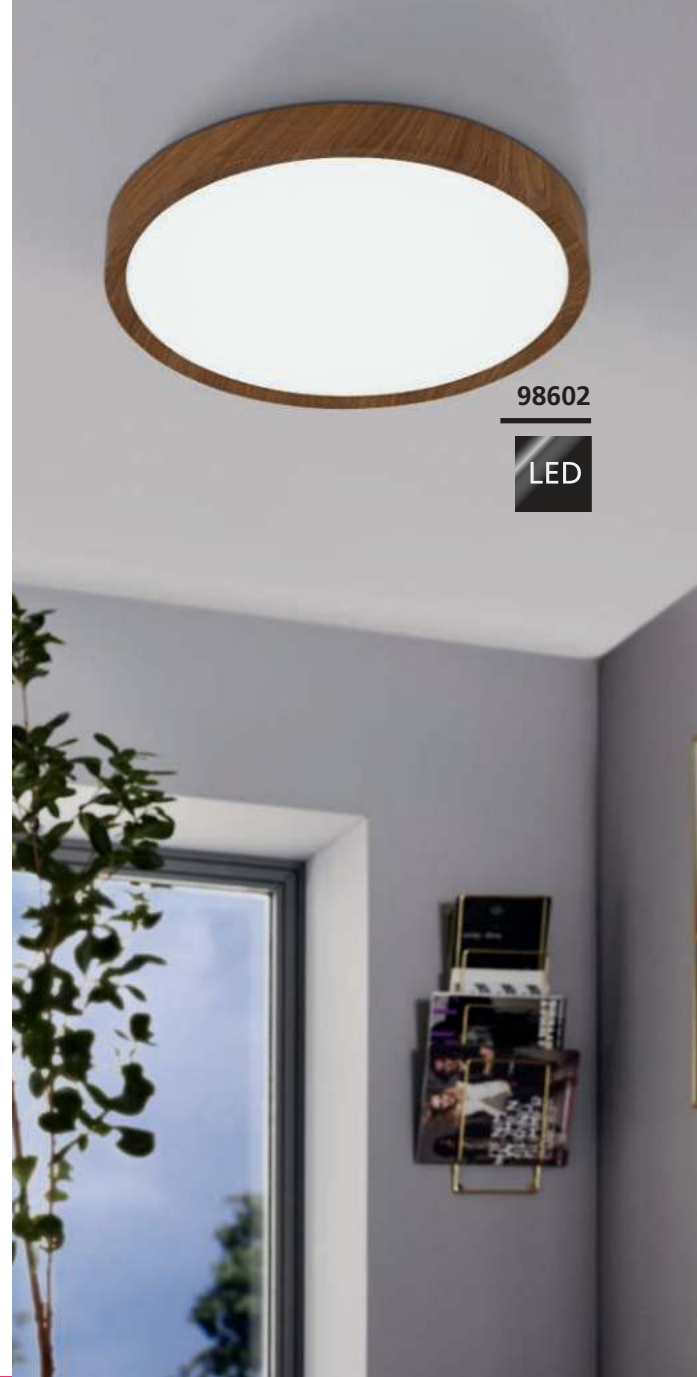

98604 MUSURITA

ceiling light; plastic, steel, black / plastic, white
 Deckenleuchte; Kunststoff, Stahl, schwarz / Kunststoff, weiss
 plafonnier; plastique, acier, noir / plastique, blanc

H 75, Ø 440



6x 5,5 W 3600 lm

98601 MUSURITA

ceiling light; plastic, steel, natural wood look / plastic, white
 Deckenleuchte; Kunststoff, Stahl, Holzoptik natur / Kunststoff, weiss
 plafonnier; plastique, acier, aspect bois naturel / plastique, blanc

H 60, Ø 340



14,6 W 1600 lm

98602 MUSURITA

ceiling light; plastic, steel, natural wood look / plastic, white
 Deckenleuchte; Kunststoff, Stahl, Holzoptik natur / Kunststoff, weiss
 plafonnier; plastique, acier, aspect bois naturel / plastique, blanc

H 75, Ø 440



6x 5,5 W 3600 lm



9 002759 986049

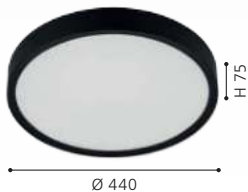

9 002759 986018



9 002759 986025

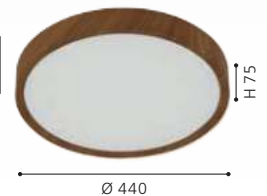



99782

LED

incl./inkl./inclus



99783

LED

incl./inkl./inclus



99779

LED

incl./inkl./inclus



99782 LAURITO

ceiling light; steel, white / plastic, grey, white
Deckenleuchte; Stahl, weiss / Kunststoff, grau, weiss
plafonnier; acier, blanc / plastique, gris, blanc

H 70, Ø 490

LED

24W

tunable
WHITE

2600lm



CONTROL
UNIT

Remote

99783 LAURITO

ceiling light; steel, white / plastic, black, white
Deckenleuchte; Stahl, weiss / Kunststoff, schwarz, weiss
plafonnier; acier, blanc / plastique, noir, blanc

H 70, Ø 490

LED

24W

tunable
WHITE

2600lm



CONTROL
UNIT

Remote

99779 SELUCI

ceiling light; steel, white / plastic, white, clear
Deckenleuchte; Stahl, weiss / Kunststoff, weiss, klar
plafonnier; acier, blanc / plastique, blanc, transparent

H 80, Ø 490

LED

4x 10W

tunable
WHITE

4600lm



CONTROL
UNIT

Remote



9 002759 997823



9 002759 997830



9 002759 997793





99781

LED

incl./inkl./inclus

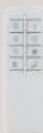

99781 SELUCI

ceiling light; steel, black / plastic, white, clear

Deckenleuchte; Stahl, schwarz / Kunststoff, weiss, klar

plafonnier; acier, noir / plastique, blanc, transparent

H 80, Ø 490



4x 10W



4600lm



Remote



9 002759 997816



SELUCI

Convenient light effect due to the indirect illumination.

Angenehmer Lichteffect durch indirekte Beleuchtung.

Effet de lumière pratique en raison de l'éclairage indirect.



99623

LED



99621

LED



99622

LED

99623 VALCASOTTO

ceiling light; steel, Mokka colour / plastic, white
 Deckenleuchte; Stahl, Mokkafarben / Kunststoff, weiss
 plafonnier; acier, café / plastique, blanc

H 75, Ø 370

LED

warm
WHITE
2500lm



24W

2500lm

99621 VALCASOTTO

ceiling light; steel, black / plastic, white
 Deckenleuchte; Stahl, schwarz / Kunststoff, weiss
 plafonnier; acier, noir / plastique, blanc

H 75, Ø 370

LED

warm
WHITE
2500lm



21,6W

2500lm

99622 VALCASOTTO

ceiling light; steel, brown / plastic, white
 Deckenleuchte; Stahl, braun / Kunststoff, weiss
 plafonnier; acier, marron / plastique, blanc

H 75, Ø 370

LED

warm
WHITE
2500lm



24W

2500lm



9 002759 996239



9 002759 996215



9 002759 996222





900463



900464



900463 LUPPINERIA

ceiling light; steel, plastic, sandy, white / wood, brown
Deckenleuchte; Stahl, Kunststoff, sandfarben, weiss / Holz, braun
plafonnier; acier, plastique, couleur sable, blanc / bois, marron

H 80, Ø 380



24W 2500lm



9 008606 244027



900464 LUPPINERIA

ceiling light; plastic, steel, white / wood, brown
Deckenleuchte; Kunststoff, Stahl, weiss / Holz, braun
plafonnier; plastique, acier, blanc / bois, marron

H 80, Ø 380



24W 2500lm



9 008606 244034





99703



99704



99703 PENJAMO

ceiling light; steel, black / plastic with crystal effect, white
Deckenleuchte; Stahl, schwarz / Kunststoff m. Kristalleffekt, weiss
plafonnier; acier, noir / plastique avec effet cristal, blanc

H 60, Ø 465



3x 7,3W 2010lm

99704 PENJAMO

ceiling light; steel, Mokka colour / plastic with crystal effect, white
Deckenleuchte; Stahl, Mokkafarben / Kunststoff m. Kristalleffekt, weiss
plafonnier; acier, café / plastique avec effet cristal, blanc

H 60, Ø 465



3x 7,3W 2010lm



9 002759 997038



9 002759 997045





900601

LED



900602

LED



900601 CALAGRANO

ceiling light; steel, black / plastic, white
 Deckenleuchte; Stahl, schwarz / Kunststoff, weiss
 plafonnier; acier, noir / plastique, blanc

H 60, Ø 380



9 008606 244997



900602 CALAGRANO

ceiling light; steel, black / plastic, white
 Deckenleuchte; Stahl, schwarz / Kunststoff, weiss
 plafonnier; acier, noir / plastique, blanc

L 375, B 375, H 60



9 008606 245000





99397

LED

99397

The wall switch controls the luminaire's light colour.

Über den Wandschalter kann die Lichtfarbe der Leuchte gesteuert werden.

La couleur de lumière du luminaire peut être commandée par l'interrupteur mural.



99398

LED

99398

The wall switch controls the luminaire's light colour.

Über den Wandschalter kann die Lichtfarbe der Leuchte gesteuert werden.

La couleur de lumière du luminaire peut être commandée par l'interrupteur mural.

99397 MENTALURGIA

wall / ceiling light; steel, white, chrome / plastic, white
Wand- / Deckenleuchte; Stahl, weiss, chrom / Kunststoff, weiss
applique / plafonnier; acier, blanc, chrome / plastique, blanc

L 495, B 465, H 65

LED 11W 1600lm tunable WHITE LED 10W 1450lm tunable WHITE LED 8W

LED 6W LED 5W



9 002759 993979



99398 MENTALURGIA

wall / ceiling light; steel, white, chrome / plastic, white
Wand- / Deckenleuchte; Stahl, weiss, chrom / Kunststoff, weiss
applique / plafonnier; acier, blanc, chrome / plastique, blanc

L 490, B 490, H 65

LED 12W 1800lm tunable WHITE LED 11W 1650lm tunable WHITE LED 7,5W

LED 5W LED 4W



9 002759 993986



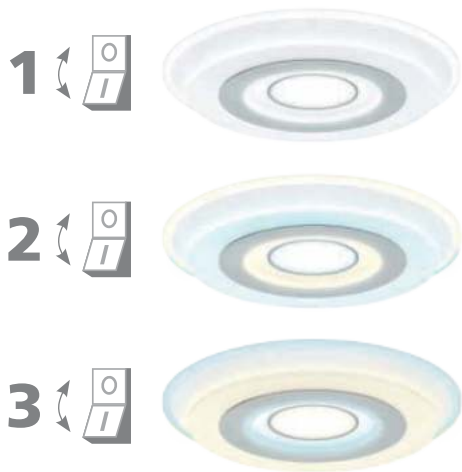

99399

The wall switch controls the luminaire's light colour.

Über den Wandschalter kann die Lichtfarbe der Leuchte gesteuert werden.

La couleur de lumière du luminaire peut être commandée par l'interrupteur mural.



99399



99399 REDUCTA 2

wall / ceiling light; plastic, white
Wand- / Deckenleuchte; Kunststoff, weiss
applique / plafonnier; plastique, blanc

H 45, Ø 490





81635



83404



81636

81635 ELLA

wall / ceiling light; steel, white / glass opal-matt, white
Wand- / Deckenleuchte; Stahl, weiss / Glas opal-matt, weiss
applique / plafonnier; acier, blanc / verre opale mat, blanc

H 92, Ø 200



E27



1x 60W

81636 ELLA

wall / ceiling light; steel, white / glass opal-matt, white
Wand- / Deckenleuchte; Stahl, weiss / Glas opal-matt, weiss
applique / plafonnier; acier, blanc / verre opale mat, blanc

H 117, Ø 280



E27



1x 60W

83404 ELLA

wall / ceiling light; steel, white / glass opal-matt, white
Wand- / Deckenleuchte; Stahl, weiss / Glas opal-matt, weiss
applique / plafonnier; acier, blanc / verre opale mat, blanc

H 127, Ø 350



E27



2x 60W



9 002759 816353

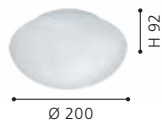

9 002759 816360



9 002759 834043





94973



94973 DURELO

ceiling light; plastic, white / glass, white
Deckenleuchte; Kunststoff, weiss / Glas, weiss
plafonnier; plastique, blanc / verre, blanc

H 195, Ø 160



E27



1x 28W



9 002759 949730





82942



83155

82942 PLANET

wall / ceiling light; steel, satin nickel / satin glass, white, clear
Wand- / Deckenleuchte; Stahl, nickel-matt / Glas satiniert, weiss, klar
applique / plafonnier; acier, nickel mat / verre satiné, blanc, transparent

H 85, Ø 290



E27



1x 25W

83155 PLANET 1

wall / ceiling light; steel, chrome / glass painted, white, clear
Wand- / Deckenleuchte; Stahl, chrom / Glas lackiert, weiss, klar
applique / plafonnier; acier, chrome / verre laqué, blanc, transparent

H 85, Ø 290



E27



1x 25W



9 002759 829421



Ø 290



9 002759 831554



Ø 290



83156



83154



83153

83156 PLANET 1

wall light; steel, chrome / glass painted, white, clear
Wandleuchte; Stahl, chrom / Glas lackiert, weiss, klar
applique; acier, chrome / verre laqué, blanc, transparent

L 290, H 145, A 85



E27 1x 60W



9 002759 831561



83153 PLANET 1

wall / ceiling light; steel, white / glass painted, white, clear
Wand- / Deckenleuchte; Stahl, weiss / Glas lackiert, weiss, klar
applique / plafonnier; acier, blanc / verre laqué, blanc, transparent

H 85, Ø 290



E27 1x 25W



9 002759 831530



83154 PLANET 1

wall light; steel, white / glass painted, white, clear
Wandleuchte; Stahl, weiss / Glas lackiert, weiss, klar
applique; acier, blanc / verre laqué, blanc, transparent

L 290, H 145, A 85



E27 1x 60W



9 002759 831547





83157



83159

83157 PLANET 1

wall / ceiling light; steel, brass / glass painted, white, clear
Wand- / Deckenleuchte; Stahl, messing / Glas lackiert, weiss, klar
applique / plafonnier; acier, laiton / verre laqué, blanc, transparent

H 85, Ø 290



E27

1x 25W

83159 PLANET 1

wall / ceiling light; steel, black / glass painted, white, clear
Wand- / Deckenleuchte; Stahl, schwarz / Glas lackiert, weiss, klar
applique / plafonnier; acier, noir / verre laqué, blanc, transparent

H 85, Ø 290



E27

1x 25W

83162 PLANET 1

wall / ceiling light; steel, satin nickel / glass painted, white, clear
Wand- / Deckenleuchte; Stahl, nickel-matt / Glas lackiert, weiss, klar
applique / plafonnier; acier, nickel mat / verre laqué, blanc, transparent

H 85, Ø 290



E27

1x 25W



9 002759 831578



Ø 290



9 002759 831592



Ø 290



9 002759 831622



Ø 290



83162



83163

83163 PLANET 1

wall light; steel, satin nickel / glass painted, white, clear
Wandleuchte; Stahl, nickel-matt / Glas lackiert, weiss, klar
applique; acier, nickel mat / verre laqué, blanc, transparent

L 290, H 145, A 85



E27



1x 60W



9 002759 831639

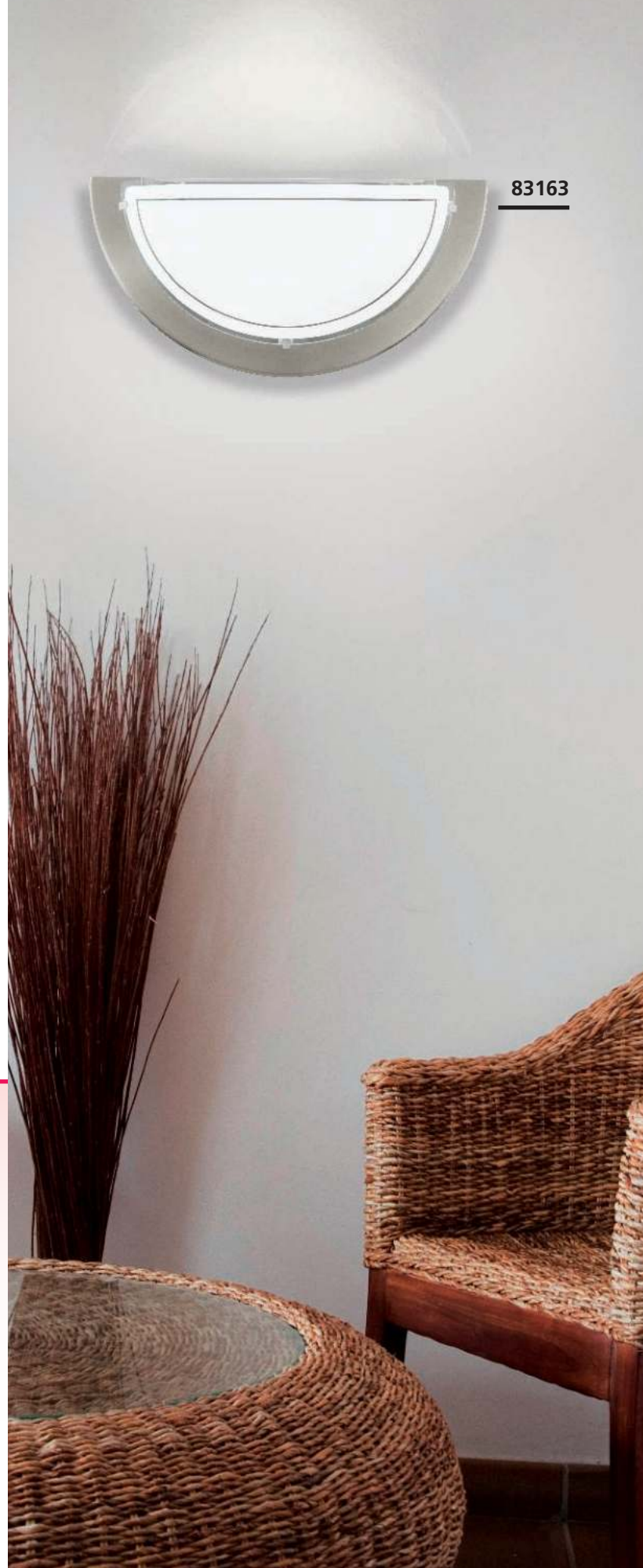



96117

LED





96111

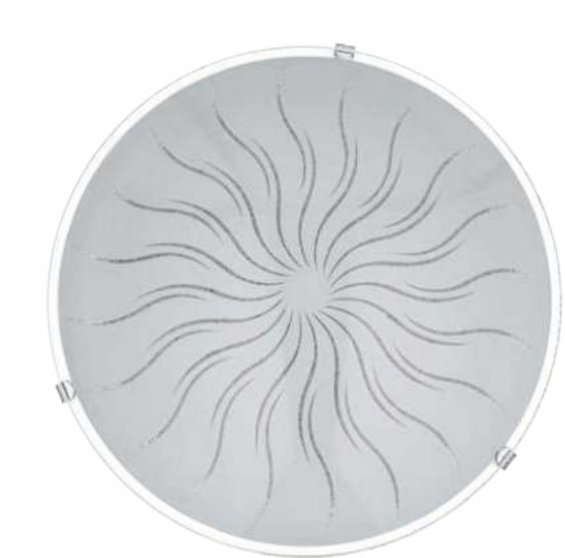

96089



96117 MARGITTA 1

wall / ceiling light; steel, white / glass, white, black, clear
Wand- / Deckenleuchte; Stahl, weiss / Glas, weiss, schwarz, klar
applique / plafonnier; acier, blanc / verre, blanc, noir, transparent

H 95, Ø 315



3x 11 W
3x
950lm



9 002759 961176



Ø 315

96089 MARGITTA 1

wall / ceiling light; steel, white / glass, granille white, clear
Wand- / Deckenleuchte; Stahl, weiss / Glas, granille weiss, klar
applique / plafonnier; acier, blanc / verre, blanc granille, transparent

H 70, Ø 250



3x 11 W
3x
950lm



9 002759 960896



Ø 250

96111 MARGITTA 1

wall / ceiling light; steel, white / glass, granille white, clear
Wand- / Deckenleuchte; Stahl, weiss / Glas, granille weiss, klar
applique / plafonnier; acier, blanc / verre, blanc granille, transparent

H 95, Ø 315



3x 11 W
3x
950lm



9 002759 961114



Ø 315



89248



89239

89248 MARS 1

wall / ceiling light; steel, white / satin glass, white, silver
 Wand- / Deckenleuchte; Stahl, weiss / Glas satiniert, weiss, silber
 applique / plafonnier; acier, blanc / verre satiné, blanc, argent

H 70, Ø 250



9 002759 892487



Ø 250

89239 MARS 1

wall / ceiling light; steel, white / satin glass, design "beams"
 Wand- / Deckenleuchte; Stahl, weiss / Glas satiniert, Motiv
 Strahlen
 applique / plafonnier; acier, blanc / verre satiné, motif «rayons»

H 70, Ø 250



9 002759 892395



Ø 250



80263



80264



89238

80264 MARS

wall / ceiling light; steel, white / satin glass, design "leaves"
Wand- / Deckenleuchte; Stahl, weiss / Glas satiniert, Motiv Blätter
applique / plafonnier; acier, blanc / verre satiné, motif «feuilles»

H 70, Ø 250



9 002759 802646



Ø 250

80263 MARS

wall / ceiling light; steel, white / satin glass, design "triangles"
Wand- / Deckenleuchte; Stahl, weiss / Glas satiniert, Motiv Dreiecke
applique / plafonnier; acier, blanc / verre satiné, motif «triangles»

H 70, Ø 250



9 002759 802639



Ø 250

89238 MARS 1

wall / ceiling light; steel, white / satin glass, design "rose"
Wand- / Deckenleuchte; Stahl, weiss / Glas satiniert, Motiv Rose
applique / plafonnier; acier, blanc / verre satiné, motif «rose»

H 70, Ø 250



9 002759 892388



Ø 250



DESIGN
HIGHLIGHT
DETAIL



95672

LED



90043

95672 MAGITTA 1

wall / ceiling light; steel, white / glass, white, clear
Wand- / Deckenleuchte; Stahl, weiss / Glas, weiss, klar
applique / plafonnier; acier, blanc / verre, blanc, transparent

H 80, Ø 250

LED

warm
WHITE



3x 11 W

3x

950 lm

90043 SCALEA 1

wall / ceiling light; steel, white / satin glass, white with decor
Wand- / Deckenleuchte; Stahl, weiss / Glas satiniert, weiss
m.Dekor
applique / plafonnier; acier, blanc / verre satiné, blanc avec décor

H 100, Ø 315



E27

1x 25 W

89758 RAYA

wall / ceiling light; steel, white, chrome / satin glass, white, silver
Wand- / Deckenleuchte; Stahl, weiss, chrom / Glas satiniert,
weiss, silber
applique / plafonnier; acier, blanc, chrome / verre satiné, blanc,
argent

H 100, Ø 315



E27

1x 25 W



9 002759 956721



Ø 250



9 002759 900434



Ø 315



9 002759 897581



Ø 315



89758



83132



84028

83132 GRAFIK

wall / ceiling light; steel / satin glass, design "lines"
Wand- / Deckenleuchte; Stahl / Glas satiniert, Motiv Linien
applique / plafonnier; acier / verre satiné, motif «lignes»

L 180, H 210, A 85



E27



1x 60W



9 002759 831325



L 180

H 210

84028 GRAFIK

wall / ceiling light; steel, silver / satin glass, white
Wand- / Deckenleuchte; Stahl, silber / Glas satiniert, weiss
applique / plafonnier; acier, argent / verre satiné, blanc

L 180, H 210, A 85



E27



1x 60W



9 002759 840280



L 180

H 210

83119 NEMO

wall light; steel, satin nickel / glass opal-matt, white
Wandleuchte; Stahl, nickel-matt / Glas opal-matt, weiss
applique; acier, nickel mat / verre opale mat, blanc

L 150, H 320, A 95



E27



1x 25W



9 002759 831196



L 150

H 320



83119



80265



7186



7184

80265 MARS

wall / ceiling light; steel, white / satin glass, white
Wand- / Deckenleuchte; Stahl, weiss / Glas satiniert, weiss
applique / plafonnier; acier, blanc / verre satiné, blanc

H 70, Ø 250



E27



1x 25W



9 002759 802653



Ø 250

7186 SALOME

wall / ceiling light; steel, chrome / glass alabaster, white
Wand- / Deckenleuchte; Stahl, chrom / Glas alabaster, weiss
applique / plafonnier; acier, chrome / verre albâtre, blanc

H 90, Ø 300



E27



1x 25W



9 002759 718602



Ø 300

7184 SALOME

wall / ceiling light; steel, chrome / glass alabaster, white
Wand- / Deckenleuchte; Stahl, chrom / Glas alabaster, weiss
applique / plafonnier; acier, chrome / verre albâtre, blanc

H 110, Ø 400



E27



2x 25W



9 002759 718404



Ø 400



7188

7188 SALOME

wall light; steel, chrome / glass alabaster, white
Wandleuchte; Stahl, chrom / Glas alabaster, weiss
applique; acier, chrome / verre albâtre, blanc

L 300, H 150, A 90



E27



1x 60W



9 002759 718800



SALOME

These luminaires have a beautiful alabaster glass.

Diese Leuchten besitzen ein wunderschönes Alabasterglas.

Ces luminaires ont un beau verre d'albâtre.





DESIGN
HIGHLIGHT
DETAIL



82741



86712

86712 MESTRE

wall / ceiling light; steel, antique-brown, gold / glass chalked, beige
Wand- / Deckenleuchte; Stahl, antik-braun, gold / Glas gekalkt, beige
applique / plafonnier; acier, marron antique, or / verre chaulé, beige
H 133, Ø 395



82741 IMPERIAL

wall / ceiling light; cast metal, bronzed / satin glass, white
Wand- / Deckenleuchte; Metallguss, brüniert / Glas satiniert, weiss
applique / plafonnier; fonte métallique, brun / verre satiné, blanc

H 140, Ø 310



9 002759 867126



9 002759 827410





89115



86715



87793

89115 ALMERA

wall light; steel, antique-brown / glass, champagne
Wandleuchte; Stahl, antik-braun / Glas, champagner
applique; acier, marron antique / verre, champagne

L 180, H 250, A 75



E14



1x 60W



9 002759 891152



86715 MESTRE

wall light; steel, antique-brown, gold / glass chalked, beige
Wandleuchte; Stahl, antik-braun, gold / Glas gekalkt, beige
applique; acier, marron antique, or / verre chaulé, beige

L 300, H 335, A 160



E27



1x 60W



9 002759 867157



87793 PASCAL 1

wall light; steel, antique-brown / glass chalked, beige
Wandleuchte; Stahl, antik-braun / Glas gekalkt, beige
applique; acier, marron antique / verre chaulé, beige

L 180, H 480, A 120



E14



1x 60W



9 002759 877934





90737

90737, 90697

Rustic luminaire series with appealing leaf decor

Rustikale Leuchtenserie mit ansprechendem Blätterdekor

Série de luminaires rustique avec un décor de feuille plaisant



90697

90737 CAMPANIA

ceiling light; steel, antique-brown, gold / glass chalked, white
Deckenleuchte; Stahl, antik-braun, gold / Glas gekalkt, weiss
plafonnier; acier, marron antique, or / verre chaulé, blanc

H 115, Ø 775



G4 15x 10W

90697 GERBERA 1

ceiling light; steel, antique-brown, gold / satin glass, white
Deckenleuchte; Stahl, antik-braun, gold / Glas satiniert, weiss
plafonnier; acier, marron antique, or / verre satiné, blanc

H 90, Ø 780



G9 6x 33W

92143 COLTI

ceiling light; steel, antique-brown / satin glass, white painted
Deckenleuchte; Stahl, antik-braun / Glas satiniert, weiss lackiert
plafonnier; acier, marron antique / verre satiné, blanc laqué

H 95, Ø 350



E27 2x 25W



9 002759 907372

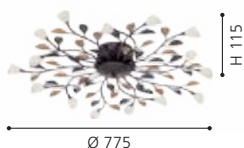

9 002759 906979

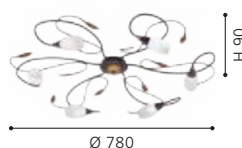

9 002759 921439

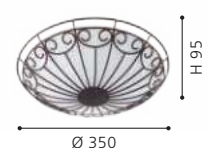



92143





97886



99348

Matching fabric luminaires
can be found from page 114.

Passende Stoffleuchten finden
Sie ab Seite 114.

Vous trouverez les luminaires à textile
assorties à partir de la page 114.

97886 SAN PERI

wall light; steel, black
Wandleuchte; Stahl, schwarz
applique; acier, noir

L 130, B 300, H 210



E27 1x 10W



9 002759 978860



99348 STAITI 1

wall light; steel, black / fabric, black
Wandleuchte; Stahl, schwarz / Textil, schwarz
applique; acier, noir / tissu, noir

L 160, H 240, A 500



E27 1x 40W



9 002759 993481





99348



96567

LED

TAZZOLI

These luminaires have a USB-connection.

Diese Leuchten verfügen über einen USB-Anschluss.

Ces luminaires disposent d'une connexion USB.



96567 TAZZOLI

wall light; steel, plastic, satin nickel, black
Wandleuchte; Stahl, Kunststoff, nickel-matt, schwarz
applique; acier, plastique, nickel mat, noir

L 65, H 300, A 160



3,8W 320lm



96566 TAZZOLI

wall light; steel, plastic, white
Wandleuchte; Stahl, Kunststoff, weiss
applique; acier, plastique, blanc

L 65, H 300, A 160



3,8W 320lm



98263 CIGLIE

wall light; aluminium, steel, black
Wandleuchte; Alu, Stahl, schwarz
applique; aluminium, acier, noir

L 180, H 180, A 210

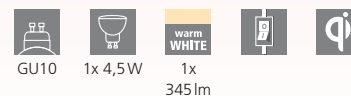

GU10 1x 4,5W 1x 345lm





99595



CARTIGNANO

This sleek, modern luminaire is multifunctional, providing illumination and a handy coat rack feature. It can be mounted directly on a wall outlet, and a cord with switch is included in your deliver.

Diese schlichte, moderne Leuchte dient nicht nur als Lichtquelle, sondern auch als Garderobe. Sie kann direkt im Wandauslass montiert werden, ein Kabel mit Schalter wird automatisch mitgeliefert.

Ce luminaire sobre et moderne peuvent non seulement servir de source de lumière, mais aussi de porte-manteau. Les deux lampes peuvent être directement montées sur une prise murale. Le câble avec interrupteur est inclus dans la livraison.

99595 CARTIGNANO

wall light; steel, black / plastic, white
Wandleuchte; Stahl, schwarz / Kunststoff, weiss
applique; acier, noir / plastique, blanc

L 780, H 180, A 35

LED

7,8W

warm
WHITE

900lm





99596



99596 CIVITATE

wall light; steel, wood, black, brown
Wandleuchte; Stahl, Holz, schwarz, braun
applique; acier, bois, noir, marron

L 760, B 100, H 85



18W



1900lm



9 002759 995966



CIVITATE

The CIVITATE LED wall luminaire features a rectangular, black metal body with rounded corners. Five brown, rubber-wood brackets provide space and support for coats and jackets, making this the ideal illuminated coat rack. The CIVITATE emits a warm, comfortable light, providing indirect illumination in your entrance area or foyer. The minimalist design complements a modern interior, and can easily be turned on and off with a switch on the cord.

Die LED Wandleuchte CIVITATE besteht aus einem rechteckigen, schwarzen Metall-Körper mit abgerundeten Ecken. Dank der fünf Halterungen aus braunem Gummibaumholz bietet die Wandlampe genügend Platz für Jacken sowie Mäntel und kann so optimal als beleuchtete Garderobe genutzt werden. Die Leuchte spendet angenehmes warmweißes Licht und schafft so eine indirekte Beleuchtung im Eingangsbereich. Die minimalistische Leuchte rundet moderne Einrichtungsstile ab und ist bequem über einen Schalter am Kabel ein- und ausschaltbar.

L'applique murale LED CIVITATE est composée d'un boîtier rectangulaire en métal noir avec des angles arrondis. Les cinq supports en bois d'hévéa brun permettent d'accrocher des vestes et des manteaux, ce qui permet à l'applique de servir également de porte-manteau. L'applique diffuse une lumière blanc chaud agréable, et ainsi un éclairage indirect pour les entrées. Minimaliste, elle complète des styles intérieurs modernes et peut être facilement actionnée grâce à l'interrupteur situé sur le câble.

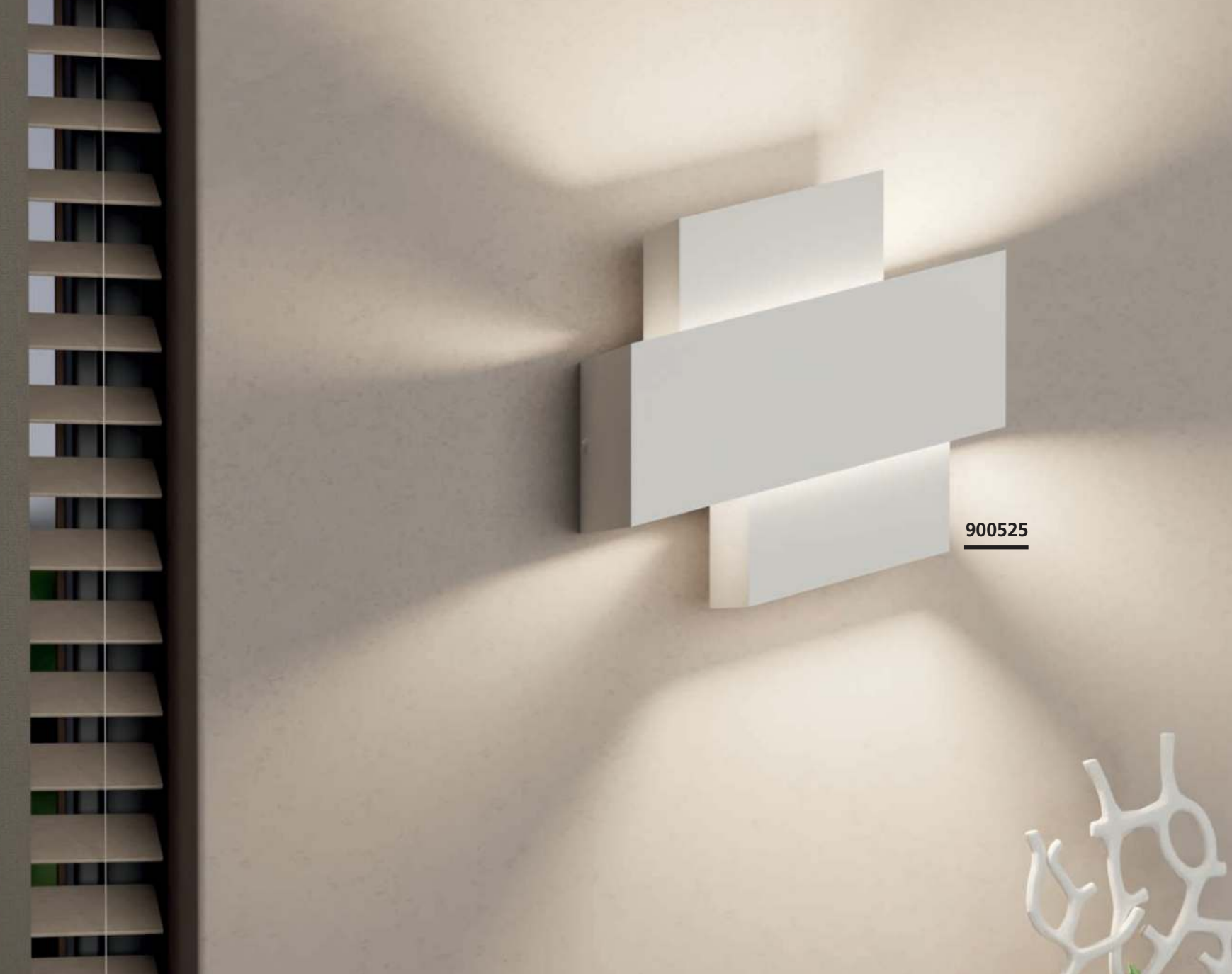

900525

900525 TIMPAROSSA

wall light; steel, white
 Wandleuchte; Stahl, weiss
 applique; acier, blanc

L 255, H 220, A 105



E27



1x 40W



9 008606 244539

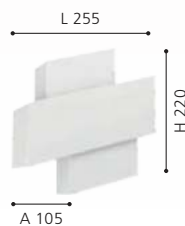

900526 TIMPAROSSA

wall light; steel, gold-coloured
 Wandleuchte; Stahl, goldfarben
 applique; acier, or

L 255, H 220, A 105



E27



1x 40W



9 008606 244546

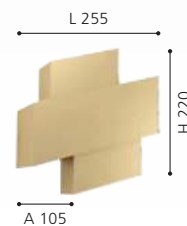

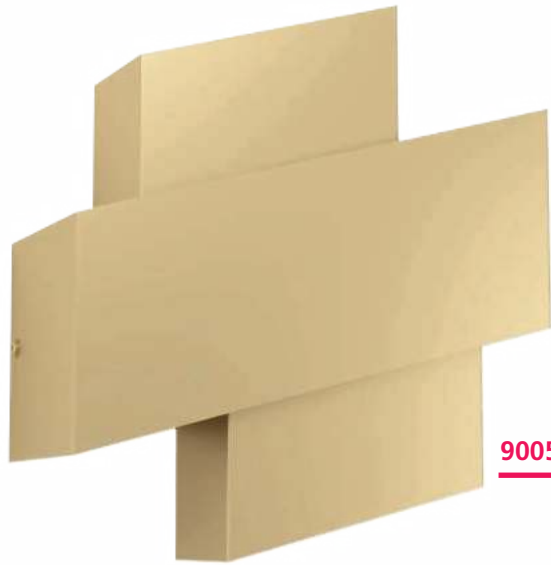

900526

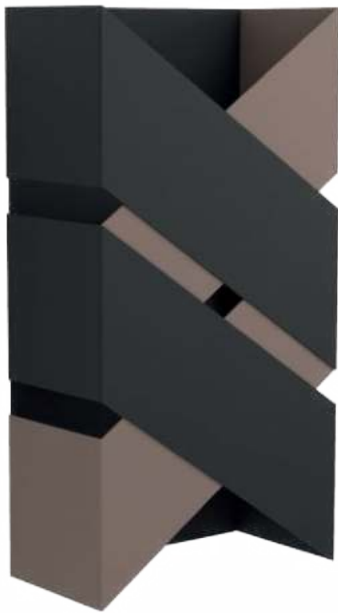

99689

LED



98841

LED

99689 GURARE

wall light; steel, black, mocha-coloured
Wandleuchte; Stahl, schwarz, mokkafarben
applique; acier, noir, café

L 125, H 240, A 85

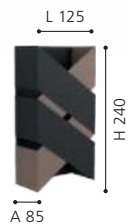
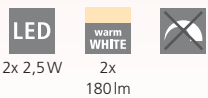

98841 ZINACUA

wall light; steel, silver
Wandleuchte; Stahl, silber
applique; acier, argent

L 225, H 310, A 85

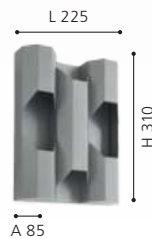
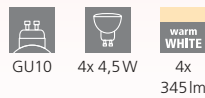



99087

LED



99086

LED



900325

LED



ZUBIALDE

The front plate of the luminaire can be swiveled. The light can be adjusted individually.

Die Frontplatte der Leuchte ist schwenkbar. Somit kann das Lichtbild individuell eingestellt werden.

La plaque frontale du luminaire peut être pivotée. La lumière peut être réglée individuellement.

99087 ZUBIALDE

wall light; aluminium, steel, black, white
Wandleuchte; Alu, Stahl, schwarz, weiss
applique; aluminium, acier, noir, blanc

L 360, H 80, A 50

LED

12W

warm
WHITE

1550lm



9 002759 990879



99086 ZUBIALDE

wall light; aluminium, steel, white
Wandleuchte; Alu, Stahl, weiss
applique; aluminium, acier, blanc

L 360, H 80, A 50

LED

12W

warm
WHITE

1550lm



9 002759 990862

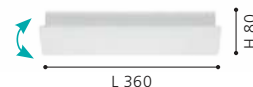



96049

LED



96048

LED

900325 ZUBIALDE

wall light; steel, wood, black, brown
Wandleuchte; Stahl, Holz, schwarz, braun
applique; acier, bois, noir, marron

L 360, H 80, A 50



12W

96049 ONO 2

wall light; aluminium, anthracite / plastic, clear
Wandleuchte; Alu, anthrazit / Kunststoff, klar
applique; aluminium, gris anthracite / plastique, transparent

L 90, H 80, A 130



2x 2,5W 500lm

96048 ONO 2

wall light; aluminium, white / plastic, clear
Wandleuchte; Alu, weiss / Kunststoff, klar
applique; aluminium, blanc / plastique, transparent

L 90, H 80, A 130



2x 2,5W 500lm



9 008606 235360



L 360

H 80



9 002759 960490



L 90

H 80

A 130



9 002759 960483



L 90

H 80

A 130



98542



98541



98543



98541 MACCARI

wall light; aluminium, steel, white / plastic, transparent
Wandleuchte; Alu, Stahl, weiss / Kunststoff, transparent
applique; aluminium, acier, blanc / plastique, transparent

L 270, H 75, A 130



10W



1300lm



9 002759 985417



98542 MACCARI

wall light; aluminium, steel, black, gold / plastic, transparent
Wandleuchte; Alu, Stahl, schwarz, gold / Kunststoff, transparent
applique; aluminium, acier, noir, or / plastique, transparent

L 270, H 75, A 130



10W



1300lm



9 002759 985424



98543 MACCARI

wall light; aluminium, steel, white, satin nickel / plastic, transparent
Wandleuchte; Alu, Stahl, weiss, nickel-matt / Kunststoff, transparent
applique; aluminium, acier, blanc, nickel mat / plastique, transparent

L 270, H 75, A 130



10W



1300lm



9 002759 985431





98544

LED



98545

LED

98544 FELONICHE

wall light; aluminium, white / plastic, transparent
 Wandleuchte; Alu, weiss / Kunststoff, transparent
 applique; aluminium, blanc / plastique, transparent

L 220, H 100, A 75



10W 1300lm

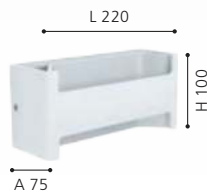

98545 FELONICHE

wall light; aluminium, black, gold / plastic, transparent
 Wandleuchte; Alu, schwarz, gold / Kunststoff, transparent
 applique; aluminium, noir, or / plastique, transparent

L 220, H 100, A 75



10W 1300lm





98421



98422



98423



98421 SANIA 4

wall light; aluminium, white
Wandleuchte; Alu, weiss
applique; aluminium, blanc

L 130, H 80, A 90



6W 670lm



9 002759 984212

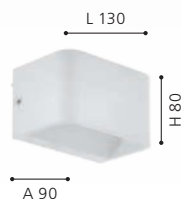

98422 SANIA 4

wall light; aluminium, white
Wandleuchte; Alu, weiss
applique; aluminium, blanc

L 200, H 80, A 90



10W 1300lm



9 002759 984229

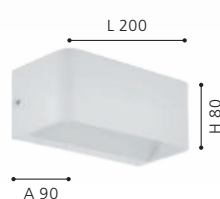

98423 SANIA 4

wall light; aluminium, white
Wandleuchte; Alu, weiss
applique; aluminium, blanc

L 365, H 80, A 90



12W 1400lm



9 002759 984236





98424

LED



98425

LED



98426

LED

98424 SANIA 4

wall light; aluminium, satin nickel
Wandleuchte; Alu, nickel-matt
applique; aluminium, nickel mat

L 130, H 80, A 90



6W 670lm



9 002759 984243

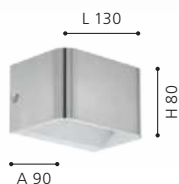

98425 SANIA 4

wall light; aluminium, satin nickel
Wandleuchte; Alu, nickel-matt
applique; aluminium, nickel mat

L 200, H 80, A 90



10W 1300lm



9 002759 984250

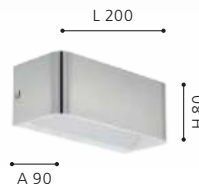

98426 SANIA 4

wall light; aluminium, satin nickel
Wandleuchte; Alu, nickel-matt
applique; aluminium, nickel mat

L 365, H 80, A 90



12W 1400lm



9 002759 984267

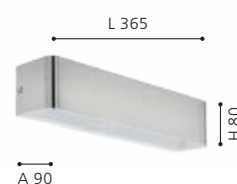



96261

LED



96261 PASSA

wall light; steel, satin nickel, chrome
Wandleuchte; Stahl, nickel-matt, chrom
applique; acier, nickel mat, chrome

L 60, H 170, A 85



GU10



2x 3W



warm
WHITE
2x
250lm



INCL.





96264

LED



95368

LED



95377

LED

96264 PASSA

wall light; steel, satin nickel, chrome
Wandleuchte; Stahl, nickel-matt, chrom
applique; acier, nickel mat, chrome

L 55, H 170, A 85

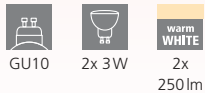

95368 PASSA

wall light; steel, chrome, white
Wandleuchte; Stahl, chrom, weiss
applique; acier, chrome, blanc

L 60, H 170, A 85

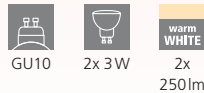

95377 PASSA

wall light; steel, chrome, white
Wandleuchte; Stahl, chrom, weiss
applique; acier, chrome, blanc

L 55, H 170, A 85





95371

LED



95379

LED

95371 PASSA

wall light; steel, brown, copper
Wandleuchte; Stahl, braun, kupfer
applique; acier, marron, cuivre

L 60, H 170, A 85

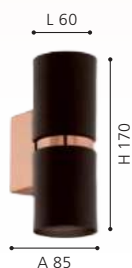
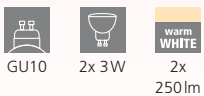

95379 PASSA

wall light; steel, brown, copper
Wandleuchte; Stahl, braun, kupfer
applique; acier, marron, cuivre

L 55, H 170, A 85

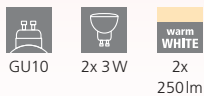

95364 PASSA

wall light; steel, black, gold
Wandleuchte; Stahl, schwarz, gold
applique; acier, noir, or

L 60, H 170, A 85

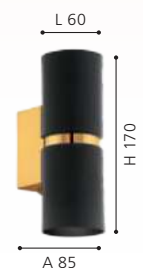



95364

LED



95373

LED

95373 PASSA

wall light; steel, black, gold
Wandleuchte; Stahl, schwarz, gold
applique; acier, noir, or

L 55, H 170, A 85



GU10



2x 3W



warm
WHITE
2x
250lm



9 002759 953737

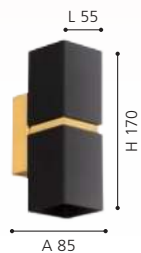



98379



98755



98759

98379 GASCUERIA

wall light; plastic, steel, gold, black
Wandleuchte; Kunststoff, Stahl, gold, schwarz
applique; plastique, acier, or, noir

L 290, H 330, A 130



E27



1x 60W



L 290



H 330

A 130



9 002759 983796

98755 ELIZONDO

wall light; steel, black, gold
Wandleuchte; Stahl, schwarz, gold
applique; acier, noir, or

L 80, H 270, A 115



E14



1x 40W



L 80

H 270

A 115



9 002759 987558

98759 FALICETTO

wall light; steel, black, gold
Wandleuchte; Stahl, schwarz, gold
applique; acier, noir, or

L 160, H 250, A 115



E27



1x 40W



L 160

H 250

A 115



9 002759 987596



900375

900375 HAYES

wall light; steel, black, gold
 Wandleuchte; Stahl, schwarz, gold
 applique; acier, noir, or

L 120, H 225, A 120



E27



1x 40W



9 008606 240555



HAYES

The golden element of the luminaire can be rotated. This allows the light to be individually adjusted.

Das goldenen Element der Leuchte ist drehbar. Dadurch lässt sich der Lichtschein individuell anpassen.

L'élément doré du luminaire peut être tourné. Cela permet de régler la lumière individuellement.



900343



900518

900343 TANURA

wall light; steel, black
Wandleuchte; Stahl, schwarz
applique; acier, noir

L 245, H 110, A 105



E27

1x 25W



9 008606 243495

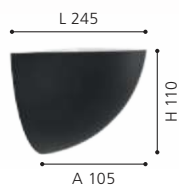

900518 GUANAL

wall light; aluminium, steel, chrome
Wandleuchte; Alu, Stahl, chrom
applique; aluminium, acier, chrome

L 600, B 50, H 60



E27

4x 40W



9 008606 244478



900517 GUANAL

wall light; aluminium, steel, black
Wandleuchte; Alu, Stahl, schwarz
applique; aluminium, acier, noir

L 600, B 50, H 60



E27

4x 40W



9 008606 244461





900517



98656



98657



98656 MONGODIO 1

wall / ceiling light; steel, white / plastic, white
 Wand- / Deckenleuchte; Stahl, weiss / Kunststoff, weiss
 applique / plafonnier; acier, blanc / plastique, blanc

H 35, Ø 200



8,6W 950lm



9 002759 986568



98657 MONGODIO 1

wall / ceiling light; steel, white / plastic, white
 Wand- / Deckenleuchte; Stahl, weiss / Kunststoff, weiss
 applique / plafonnier; acier, blanc / plastique, blanc

H 35, Ø 250



11,4W 1300lm



9 002759 986575





98676

LED



98676 ELGVERO

wall / ceiling light; steel, white / plastic, white
 Wand- / Deckenleuchte; Stahl, weiss / Kunststoff, weiss
 applique / plafonnier; acier, blanc / plastique, blanc

H 100, Ø 250

LED	warm WHITE	LED	warm WHITE	LED
6,5W	750lm	8,6W	950lm	13W

warm WHITE		
1500lm		



98676

By turning you can adjust the luminaire individually.
 Durch Drehen kann man die Leuchte individuell einstellen.
 En tournant, vous pouvez régler la lampe individuellement.



30658

LED



30659

LED



33941

LED

30658 CADEGAL

ceiling light; steel, black / plastic, white
 Deckenleuchte; Stahl, schwarz / Kunststoff, weiss
 plafonnier; acier, noir / plastique, blanc

L 200, B 200, H 50

LED

neutral
WHITE
7,8W 1200lm



9 002759 306588

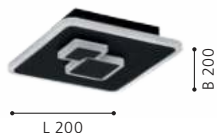

30659 CADEGAL

ceiling light; steel, black / plastic, white
 Deckenleuchte; Stahl, schwarz / Kunststoff, weiss
 plafonnier; acier, noir / plastique, blanc

H 50, Ø 200

LED

neutral
WHITE
7,8W 1100lm



9 002759 306595

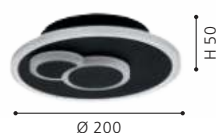

33941 CADEGAL

ceiling light; steel, white / plastic, white
 Deckenleuchte; Stahl, weiss / Kunststoff, weiss
 plafonnier; acier, blanc / plastique, blanc

L 200, B 200, H 50

LED

neutral
WHITE
7,8W 1200lm



9 002759 339418

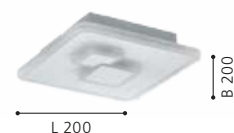



33942

LED



33964

LED



33942 CADEGAL

ceiling light; steel, white / plastic, white
Deckenleuchte; Stahl, weiss / Kunststoff, weiss
plafonnier; acier, blanc / plastique, blanc

H 50, Ø 200



7,8W 1100lm

33964 REMIDOS

ceiling light; steel, white / plastic, white
Deckenleuchte; Stahl, weiss / Kunststoff, weiss
plafonnier; acier, blanc / plastique, blanc

H 90, Ø 400



18,5W 2600lm



9 002759 339425



9 002759 339647





98888



96037



96038



98888 METRASS

wall light; aluminium, black / plastic, satined
 Wandleuchte; Alu, schwarz / Kunststoff, satiniert
 applique; aluminium, noir / plastique, satiné

L 200, H 105, A 60



1x 5,6W 680lm

96037 METRASS

wall light; aluminium, white / plastic, satined
 Wandleuchte; Alu, weiss / Kunststoff, satiniert
 applique; aluminium, blanc / plastique, satiné

L 200, H 105, A 60



1x 5,6W 680lm

96038 METRASS

wall light; aluminium, satin nickel / plastic, satined
 Wandleuchte; Alu, nickel-matt / Kunststoff, satiniert
 applique; aluminium, nickel mat / plastique, satiné

L 200, H 105, A 60



1x 5,6W 680lm



9 002759 988883

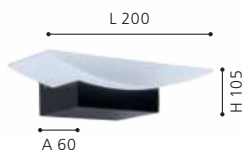

9 002759 960377

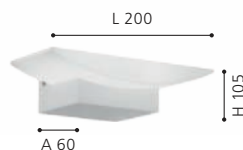

9 002759 960384

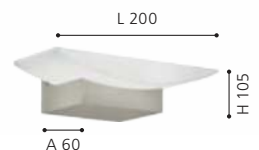



96042



96043



96042 METRASS 2

wall / ceiling light; aluminium, white / plastic, satined
 Wand- / Deckenleuchte; Alu, weiss / Kunststoff, satiniert
 applique / plafonnier; aluminium, blanc / plastique, satiné

L 170, H 200, A 55



2x 4,5W 960lm



9 002759 960421



96043 METRASS 2

wall / ceiling light; aluminium, satin nickel / plastic, satined
 Wand- / Deckenleuchte; Alu, nickel-matt / Kunststoff, satiniert
 applique / plafonnier; aluminium, nickel mat / plastique, satiné

L 170, H 200, A 55



2x 4,5W 960lm



9 002759 960438





96039

LED



96041



96039 METRASS 1

wall light; aluminium, white / plastic, satiné
 Wandleuchte; Alu, weiss / Kunststoff, satiniert
 applique; aluminium, blanc / plastique, satiné

L 130, H 130, A 50

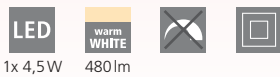

1x 4,5W 480lm



96041 METRASS 1

wall light; aluminium, satin nickel / plastic, satiné
 Wandleuchte; Alu, nickel-matt / Kunststoff, satiniert
 applique; aluminium, nickel mat / plastique, satiné

L 130, H 130, A 50



1x 4,5W 480lm





99606

LED



99607

LED



99609

LED

99606 SARGINTO

wall / ceiling light; steel, white / plastic, white
Wand- / Deckenleuchte; Stahl, weiss / Kunststoff, weiss
applique / plafonnier; acier, blanc / plastique, blanc

L 590, B 140, H 45



99607 SARGINTO

wall / ceiling light; steel, white / plastic, white
Wand- / Deckenleuchte; Stahl, weiss / Kunststoff, weiss
applique / plafonnier; acier, blanc / plastique, blanc

L 590, B 130, H 45

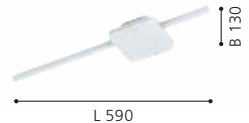



99608

LED

99609 SARGINTO

wall / ceiling light; steel, black / plastic, white
 Wand- / Deckenleuchte; Stahl, schwarz / Kunststoff, weiss
 applique / plafonnier; acier, noir / plastique, blanc

L 590, B 130, H 45



99608 SARGINTO

wall / ceiling light; steel, black / plastic, white
 Wand- / Deckenleuchte; Stahl, schwarz / Kunststoff, weiss
 applique / plafonnier; acier, noir / plastique, blanc

L 590, B 140, H 45



BATH & MIRROR LUMINAIRES

BAD- & SPIEGELLEUCHTEN

LUMINAIRES DE BAIN & MIROIR

PURE RELAXATION

Turn your bathroom into your personal wellness oasis. Trendy bathroom and mirror luminaires give a pleasant light and ensure relaxation and comfort.

ENTSPANNUNG PUR

Verwandeln Sie Ihr Badezimmer in eine persönliche Wohlfühloase. Trendige Bad- und Spiegelleuchten spenden ein angenehmes Licht und sorgen für Entspannung und Ihr Wohlbefinden.





DE LA PURE DÉTENTE

Transformez votre salle de bains en un îlot personnel de bien-être. Des éclairages à la mode de miroirs et de bain confèrent une lumière agréable et vous assurent de la détente et du bien-être.



OVERVIEW

BATH & MIRROR LUMINAIRES

 AMEZOLA p. 600	 SAN PERI 1 p. 601	 TAMARA 1 p. 602-603	 ALMONTE p. 604	 TOLORICO p. 606	 PALMITAL p. 608-609	 MOSIANO p. 609	 WASAO 1 p. 609
 BARI-M p. 610	 FRANIA p. 610, 612	 FRANIA-S p. 611	 MANILVA 1 p. 612	 PINETTO p. 614-615	 LED PALERMO p. 615	 LED CARPI p. 616-617	 FUEVA 5 p. 618-626
 ROMENDO 1 p. 628-629	 SIDERNO p. 630	 SANIA 5 p. 630-631	 GEMILIANA p. 632	 VERDELLO p. 632-633	 ALCUDIA p. 633	 CABUS p. 634-635	 CALNOVA p. 635
 TORRETTA p. 635	 TRAGACETE 1 p. 636-637	 GITA 2 p. 638	 TABIANO p. 641	 VADUMI p. 642	 PANDELLA 1 p. 644-647	 PANDELLA 2 p. 644, 648	 VINCHIO p. 648
 PALMERA p. 650	 ZOLA p. 650	 BARI 1 p. 651	 STICKER p. 651	 BUENAVISTA p. 652	 BUENAVISTA 1 p. 654	 BUENAVISTA 2 p. 654-655	
 TABIANO-Z p. 49	 JUAREZA-Z p. 49	 FUEVA-Z p. 68-79					

You can also find bathroom and mirror lights in EGLO connect.Z.
 Bad und Spiegelleuchten finden sie auch in EGLO connect.Z.
 Vous pouvez également trouver des lampes de salle de bain et de miroir dans EGLO connect.Z.

 This product is available in different colors and shapes./ Dieser Artikel ist in unterschiedlichen Farben und Formen verfügbar.
 Cet article est disponible en différentes couleurs et formes.

COLOUR RENDERING INDEX

FARBWIEDERGABE-INDEX

L'INDICE DE RESTITUTION DE COULEURS

QUALITY CRITERION COLOUR RENDERING

The colour rendering index Ra describes the colour rendering quality of lamps. The higher the Ra value, the less will the artificial light change the colour of an object. The maximum Ra value (e.g. the Ra value of the sun) is 100.

Therefore, lamps with an Ra above 90 will make you look better.

Lamps with an Ra value above 90 are marked with this button: 



QUALITÄTSKRITERIUM FARBWIEDERGABE

Mit dem Farbwiedergabe-Index Ra wird die Qualität der Farbwiedergabe von Leuchten beschrieben. Je höher der Ra-Wert ist, desto weniger verfälscht das künstliche Licht die Farbe von Objekten. Der maximale Ra-Wert (z.B. der Ra-Wert der Sonne) ist 100.

Leuchten mit Ra >90 lassen Sie somit besser aussehen.

Leuchten die einen Ra-Wert von >90 haben, sind mit diesem Button gekennzeichnet: 

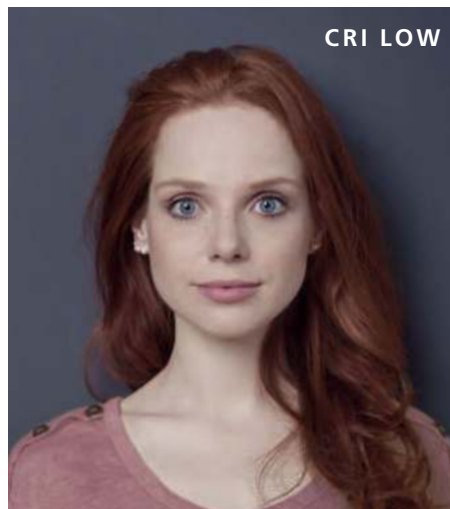

CRITÈRE DE QUALITÉ INDIQUANT LA RESTITUTION DES COULEURS

L'indice de restitution de couleurs Ra décrit la qualité de restitution des éclairages. Plus la valeur Ra est élevée, moins la lumière artificielle falsifie la couleur des objets. La valeur Ra maximale (par ex. la valeur Ra du soleil) est 100.

Ainsi, favorisez des lampes avec une valeur Ra > 90.

Les lampes ayant une valeur Ra > 90 sont identifiées par ce bouton: 



AMEZOLA



99124



99123



99122

99123 AMEZOLA

wall light; steel, black / glass, clear
Wandleuchte; Stahl, schwarz / Glas, klar
applique; acier, noir / verre, transparent

L 110, H 260, A 100



E27

1x 60W

IP44



9 002759 991234



A 100

99124 AMEZOLA

wall light; steel, black / glass, clear
Wandleuchte; Stahl, schwarz / Glas, klar
applique; acier, noir / verre, transparent

L 110, H 380, A 100



E27

2x 60W

IP44



9 002759 991241



A 100

99122 AMEZOLA

wall / ceiling light; steel, black / glass, clear
Wand- / Deckenleuchte; Stahl, schwarz / Glas, klar
applique / plafonnier; acier, noir / verre, transparent

L 290, H 290, A 130



E27

2x 40W

IP44



9 002759 991227



L 290



900428

LED

900428 SAN PERI 1

wall light; steel, black, white
Wandleuchte; Stahl, schwarz, weiss
applique; acier, noir, blanc

L 130, H 180, A 160



GU10



1x 3W



1x
warm
WHITE
240lm



IP44



9 008606 243877



INCL.





95994

LED



95993

LED



95995

LED

95993 TAMARA 1

spot; steel, glass, white, chrome
Spot; Stahl, Glas, weiss, chrom
spot; acier, verre, blanc, chrome

L 120, B 120



95994 TAMARA 1

spot; steel, glass, white, chrome
Spot; Stahl, Glas, weiss, chrom
spot; acier, verre, blanc, chrome

L 460, B 70

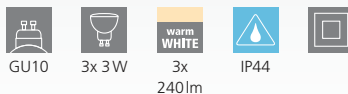

95995 TAMARA 1

spot; steel, glass, white, chrome
Spot; Stahl, Glas, weiss, chrom
spot; acier, verre, blanc, chrome

L 240, B 260

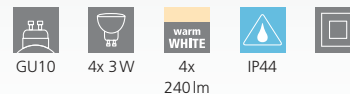

9 002759 959937



L 120

B 120



9 002759 959944



L 460

B 70



9 002759 959951



L 240

B 260



33677

LED



33678

LED

33677 TAMARA 1

spot; steel, black, chrome / glass, clear
 Spot; Stahl, schwarz, chrom / Glas, klar
 spot; acier, noir, chrome / verre, transparent

L 120, B 120

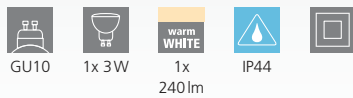

33678 TAMARA 1

spot; steel, black, chrome / glass, clear
 Spot; Stahl, schwarz, chrom / Glas, klar
 spot; acier, noir, chrome / verre, transparent

L 240, B 260

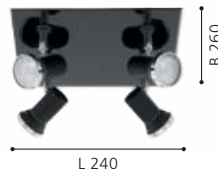
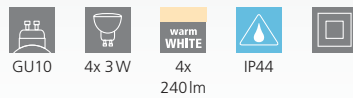

DESIGN
HIGHLIGHT
DETAIL



94879
LED



97699
LED

94879 ALMONTE

wall light; steel, chrome / brilliant glass, clear
Wandleuchte; Stahl, chrom / Brillantglas, klar
Applique; acier, chrome / verre brillant, transparent

L 110, H 230, A 170

-  G9
-  1x 3W
-  warm WHITE
1x 320lm
-  IP44
- 



INCL.



97699 ALMONTE

ceiling light; steel, chrome / brilliant glass, clear
Deckenleuchte; Stahl, chrom / Brillantglas, klar
plafonnier; acier, chrome / verre brillant, transparent

H 300, Ø 500

-  G9
-  8x 3W
-  warm WHITE
8x 320lm
-  IP44
- 



INCL.

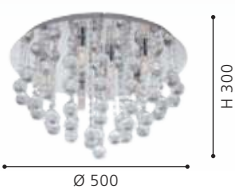

94878 ALMONTE

ceiling light; steel, chrome / brilliant glass, clear
Deckenleuchte; Stahl, chrom / Brillantglas, klar
plafonnier; acier, chrome / verre brillant, transparent

H 230, Ø 350

-  G9
-  4x 3W
-  warm WHITE
4x 320lm
-  IP44
- 



INCL.





94878

LED





TOLORICO

These luminaires come with high quality brilliant glass.

Diese Leuchten sind mit hochwertigem Brillantglas ausgestattet.

Ces lumières sont fabriquées avec une haute qualité Equipé de verre brillant.



97054

LED



97055

LED

97054 TOLORICO

wall / ceiling light; stainless steel, chrome / plastic, brilliant glass, clear

Wand- / Deckenleuchte; Edelstahl, chrom / Kunststoff, Brillantglas, klar

Applique/Plafonnier; acier inoxydable, chrome / plastique, verre brillant, transparent
L 350, B 100, H 70



8W



1000lm



IP44



97055 TOLORICO

wall / ceiling light; stainless steel, chrome / plastic, brilliant glass, clear

Wand- / Deckenleuchte; Edelstahl, chrom / Kunststoff, Brillantglas, klar

Applique/Plafonnier; acier inoxydable, chrome / plastique, verre brillant, transparent
L 570, B 100, H 75



20,5W



2700lm



IP44



97056 TOLORICO

wall / ceiling light; stainless steel, chrome / plastic, brilliant glass, clear

Wand- / Deckenleuchte; Edelstahl, chrom / Kunststoff, Brillantglas, klar

Applique/Plafonnier; acier inoxydable, chrome / plastique, verre brillant, transparent
L 350, B 350, H 75



22W



3000lm



IP44



9 002759 970543



9 002759 970550



9 002759 970567





97056

LED



97965

LED

97965 PALMITAL

wall / ceiling light; aluminium, steel, chrome / plastic, clear
Wand- / Deckenleuchte; Alu, Stahl, chrom / Kunststoff, klar
applique / plafonnier; aluminium, acier, chrome / plastique,
transparent

L 880, B 100, H 90

LED

2x 11 W

warm
WHITE

2700 lm



IP44



9 002759 979652





97966



94626



94884



97966 PALMITAL

wall light; aluminium, steel, chrome / plastic, clear
Wandleuchte; Alu, Stahl, chrom / Kunststoff, klar
applique; aluminium, acier, chrome / plastique, transparent

L 595, H 80, A 65



1x 11 W 1350 lm

94626 MOSIANO

wall / ceiling light; stainless steel, chrome / glass opal-matt, white
Wand- / Deckenleuchte; Edelstahl, chrom / Glas opal-matt, weiss
applique / plafonnier; acier inoxydable, chrome / verre opale mat, blanc

H 115, Ø 110



1x 3,3 W 340 lm

94884 WASAO 1

wall / ceiling light; stainless steel, chrome / glass painted, white
Wand- / Deckenleuchte; Edelstahl, chrom / Glas lackiert, weiss
applique / plafonnier; acier inoxydable, chrome / verre laqué, blanc

L 320, B 320, H 60



4x 5,4 W 2040 lm



9 002759 979669



9 002759 946265



9 002759 948849





97531



97531



97884

LED

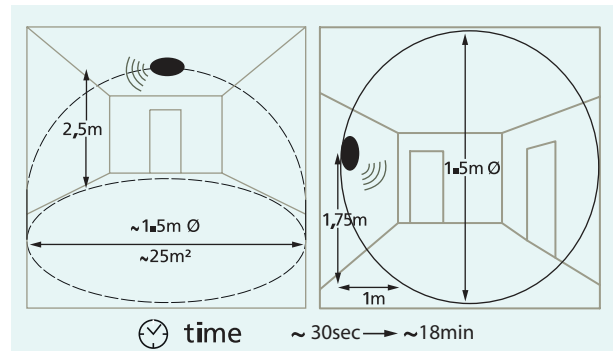

time ~ 30sec → ~18min

97531

This luminaire comes with an integrated motion sensor.
The sensor is mounted invisibly behind the glass.

Diese Leuchte ist mit einem integrierten Bewegungssensor ausgestattet.
Der Sensor ist unsichtbar hinter dem Glas befestigt.

Ce luminaire vient avec un capteur de mouvement intégré.
Le capteur est attaché invisiblement derrière le verre.

97531 BARI-M

ceiling light; plastic, white / glass, white
Deckenleuchte; Kunststoff, weiss / Glas, weiss
plafonnier; plastique, blanc / verre, blanc

H 110, Ø 275



E27



1x 20W



IP44



97884 FRANIA

wall / ceiling light; steel, white / plastic, white
Wand- / Deckenleuchte; Stahl, weiss / Kunststoff, weiss
applique / plafonnier; acier, blanc / plastique, blanc

H 70, Ø 330



14,6 W



1600 lm



IP44



9 002759 975319



Ø 275



9 002759 978846



Ø 330



900619



900364



900363



900619 FRANIA-S

wall / ceiling light; steel, white / plastic with crystal effect, white
Wand- / Deckenleuchte; Stahl, weiss / Kunststoff m.Kristalleffekt, weiss
applique / plafonnier; acier, blanc / plastique avec effet cristal, blanc

H 55, Ø 310



18W 1850lm

900363 FRANIA-S

wall / ceiling light; steel, white / plastic with crystal effect, white
Wand- / Deckenleuchte; Stahl, weiss / Kunststoff m.Kristalleffekt, weiss
applique / plafonnier; acier, blanc / plastique avec effet cristal, blanc

H 55, Ø 310



18W 1850lm

900364 FRANIA-S

wall / ceiling light; steel, white / plastic with crystal effect, white
Wand- / Deckenleuchte; Stahl, weiss / Kunststoff m.Kristalleffekt, weiss
applique / plafonnier; acier, blanc / plastique avec effet cristal, blanc

L 330, B 330, H 70



14,6W 1600lm



9 008606 245161



9 008606 234455



9 008606 234462





97885

LED



96231

LED

97885 FRANIA

wall / ceiling light; steel, white / plastic, white
Wand- / Deckenleuchte; Stahl, weiss / Kunststoff, weiss
applique / plafonnier; acier, blanc / plastique, blanc

L 330, B 330, H 70



14,6W 1600lm

96231 MANILVA 1

wall light; steel, satin nickel / plastic, white
Wandleuchte; Stahl, nickel-matt / Kunststoff, weiss
applique; acier, nickel mat / plastique, blanc

L 290, B 290, H 70



4x 3,6W 1480lm

96229 MANILVA 1

wall light; steel, chrome / plastic, white
Wandleuchte; Stahl, chrom / Kunststoff, weiss
applique; acier, chrome / plastique, blanc

L 290, B 290, H 70



4x 3,6W 1480lm



9 002759 978853



9 002759 962319



9 002759 962296





96229

LED



900366

LED



900366 PINETTO

wall / ceiling light; steel, white / plastic, white, black
Wand- / Deckenleuchte; Stahl, weiss / Kunststoff, weiss, schwarz
applique / plafonnier; acier, blanc / plastique, blanc, noir

H 65, Ø 340

LED

18W

neutral
WHITE

1850lm



IP44



9 008606 235971





900365

LED



94998

LED



94999

LED

900365 PINETTO

wall / ceiling light; steel, white / plastic, white, chrome
Wand- / Deckenleuchte; Stahl, weiss / Kunststoff, weiss, chrom
applique / plafonnier; acier, blanc / plastique, blanc, chrome

H 65, Ø 340



18W 1850lm

94998 LED PALERMO

wall / ceiling light; steel, chrome / satin glass, white painted
Wand- / Deckenleuchte; Stahl, chrom / Glas satiniert, weiss
lackiert
applique / plafonnier; acier, chrome / verre satiné, blanc laqué

H 60, Ø 225



3x 3,6W 1110lm

94999 LED PALERMO

wall / ceiling light; steel, chrome / satin glass, white painted
Wand- / Deckenleuchte; Stahl, chrom / Glas satiniert, weiss
lackiert
applique / plafonnier; acier, chrome / verre satiné, blanc laqué

H 75, Ø 300



3x 5,7W 2100lm



9 008606 235964



9 002759 949983



9 002759 949990



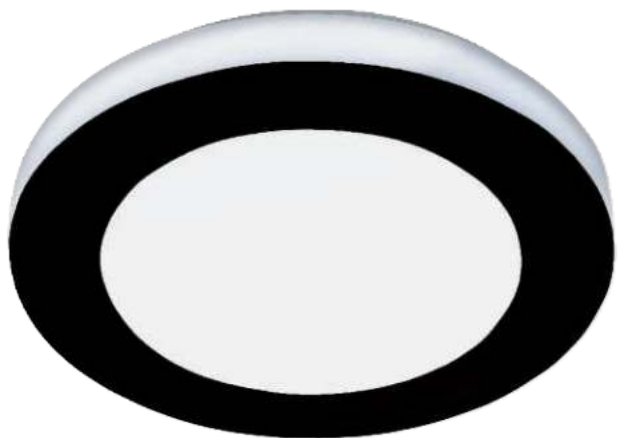

33682



94967



95282



33682 LED CARPI

wall / ceiling light; steel, black, white / plastic, white
Wand- / Deckenleuchte; Stahl, schwarz, weiss / Kunststoff, weiss
applique / plafonnier; acier, noir, blanc / plastique, blanc

Ø 300, A 75



3x 11 W
3x
950 lm

95282 LED CARPI

wall / ceiling light; steel, white, chrome / plastic, white
Wand- / Deckenleuchte; Stahl, weiss, chrom / Kunststoff, weiss
applique / plafonnier; acier, blanc, chrome / plastique, blanc

Ø 300, A 75



3x 3,6 W
1110 lm

94967 LED CARPI

wall / ceiling light; steel, aluminium, white, brushed aluminium / plastic, white
Wand- / Deckenleuchte; Stahl, Alu, weiss, alu-gebürstet / Kunststoff, weiss
applique / plafonnier; acier, aluminium, blanc, aluminium brossé / plastique, blanc
Ø 300, A 75



3x 3,6 W
1110 lm



9 002759 336820



Ø 300



9 002759 952822



Ø 300



9 002759 949679



Ø 300



900369

LED



95283

LED

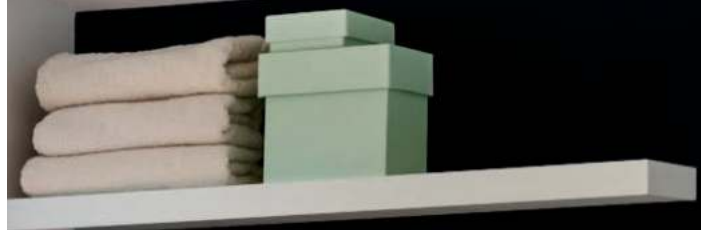

900369 LED CARPI

ceiling light; steel, brushed brass, white / plastic, white
 Deckenleuchte; Stahl, messing-gebürstet, weiss / Kunststoff, weiss
 plafonnier; acier, laiton brossé, blanc / plastique, blanc

Ø 300, A 75

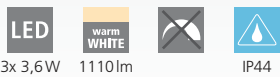

3x 3,6W 1110lm

95283 LED CARPI

wall / ceiling light; steel, white, chrome / plastic, white
 Wand- / Deckenleuchte; Stahl, weiss, chrom / Kunststoff, weiss
 applique / plafonnier; acier, blanc, chrome / plastique, blanc

Ø 385, A 75



3x 7,3W 2220lm



9 008606 240623



Ø 300



9 002759 952839



Ø 385



99202, 99203, 99206, 99207

These luminaires are protected against splash water.

Diese Leuchten sind gegen Spritzwasser geschützt.

Les luminaires sont protégées contre les éclaboussures d'eau.



IP44

	0	1	2	3
EU	X	X	✓	✓
FR	X	X	X	✓

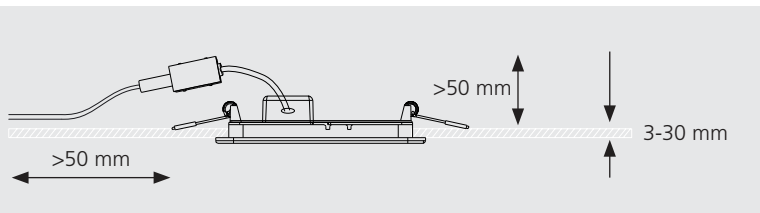

99202, 99203, 99206, 99207

Slim design and minimal installation depth. This makes it ideal for ceiling constructions with little space. Easy installation / replacement of the lights with practical connectors.

Schlanke Bauform und minimale Einbautiefe. Dadurch ideal für Deckenkonstruktionen mit wenig Platz. Einfache Montage / Austausch der Leuchten durch praktischen Verbinder.

Conception mince et profondeur d'installation minimale. Cela le rend idéal pour les constructions de plafond avec peu d'espace. Installation / remplacement facile des lumières avec des connecteurs pratiques.

99202 FUEVA 5

recessed light; steel, white / plastic, white
Einbauleuchte; Stahl, weiss / Kunststoff, weiss
luminaire encastrable; acier, blanc / plastique, blanc

Ø 86, ET 26



99203 FUEVA 5

recessed light; steel, white / plastic, white
Einbauleuchte; Stahl, weiss / Kunststoff, weiss
luminaire encastrable; acier, blanc / plastique, blanc

Ø 166, ET 26



99206 FUEVA 5

recessed light; steel, white / plastic, white
Einbauleuchte; Stahl, weiss / Kunststoff, weiss
luminaire encastrable; acier, blanc / plastique, blanc

Ø 86, ET 26





99203

LED



99206

LED

99207 FUEVA 5

recessed light; steel, white / plastic, white
Einbauleuchte; Stahl, weiss / Kunststoff, weiss
luminaire encastrable; acier, blanc / plastique, blanc

Ø 166, ET 26



11 W

1350 lm

Ø 155

IP44



9 002759 992071



Ø 166



99207

LED

99204, 99205, 99208, 99209

These luminaires are protected against splash water.

Diese Leuchten sind gegen Spritzwasser geschützt.

Les luminaires sont protégées contre les éclaboussures d'eau.



	0	1	2	3
EU	X	X	✓	✓
FR	X	X	X	✓



99208



99209



99204, 99205, 99208, 99209

Slim design and minimal installation depth. This makes it ideal for ceiling constructions with little space. Easy installation / replacement of the lights with practical connectors.

Schlanke Bauform und minimale Einbautiefe. Dadurch ideal für Deckenkonstruktionen mit wenig Platz. Einfache Montage / Austausch der Leuchten durch praktischen Verbinder.

Conception mince et profondeur d'installation minimale. Cela le rend idéal pour les constructions de plafond avec peu d'espace. Installation / remplacement facile des lumières avec des connecteurs pratiques.

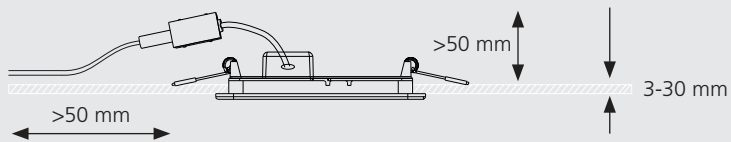

99208 FUEVA 5

recessed light; steel, chrome / plastic, white
Einbauleuchte; Stahl, chrom / Kunststoff, weiss
luminaire encastrable; acier, chrome / plastique, blanc

Ø 86, ET 26



99209 FUEVA 5

recessed light; steel, chrome / plastic, white
Einbauleuchte; Stahl, chrom / Kunststoff, weiss
luminaire encastrable; acier, chrome / plastique, blanc

Ø 166, ET 26



99205 FUEVA 5

recessed light; steel, chrome / plastic, white
Einbauleuchte; Stahl, chrom / Kunststoff, weiss
luminaire encastrable; acier, chrome / plastique, blanc

Ø 166, ET 26





99205

LED



99204

LED

99204 FUEVA 5

recessed light; steel, chrome / plastic, white
Einbauleuchte; Stahl, chrom / Kunststoff, weiss
luminaire encastrable; acier, chrome / plastique, blanc

Ø 86, ET 26



Ø 86

99211, 99212, 99213, 99214

These luminaires are protected against splash water.

Diese Leuchten sind gegen Spritzwasser geschützt.

Les luminaires sont protégées contre les éclaboussures d'eau.



	0	1	2	3
EU	X	X	✓	✓
FR	X	X	X	✓



99213

LED



99214

LED

99211, 99212, 99213, 99214

Slim design and minimal installation depth. This makes it ideal for ceiling constructions with little space. Easy installation / replacement of the lights with practical connectors.

Schlanke Bauform und minimale Einbautiefe. Dadurch ideal für Deckenkonstruktionen mit wenig Platz. Einfache Montage / Austausch der Leuchten durch praktischen Verbinder.

Conception mince et profondeur d'installation minimale. Cela le rend idéal pour les constructions de plafond avec peu d'espace. Installation / remplacement facile des lumières avec des connecteurs pratiques.

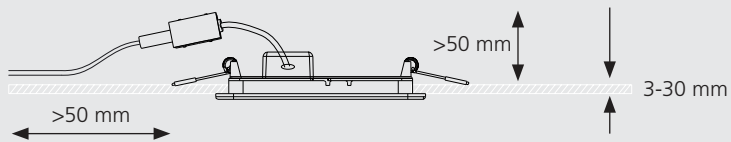

99213 FUEVA 5

recessed light; steel, black / plastic, white
Einbauleuchte; Stahl, schwarz / Kunststoff, weiss
luminaire encastrable; acier, noir / plastique, blanc

Ø 86, ET 26



Ø 86

99214 FUEVA 5

recessed light; steel, black / plastic, white
Einbauleuchte; Stahl, schwarz / Kunststoff, weiss
luminaire encastrable; acier, noir / plastique, blanc

Ø 166, ET 26



Ø 166

99212 FUEVA 5

recessed light; steel, black / plastic, white
Einbauleuchte; Stahl, schwarz / Kunststoff, weiss
luminaire encastrable; acier, noir / plastique, blanc

Ø 166, ET 26



Ø 166



99212

LED



99211

LED

99211 FUEVA 5

recessed light; steel, black / plastic, white
Einbauleuchte; Stahl, schwarz / Kunststoff, weiss
luminaire encastrable; acier, noir / plastique, blanc

Ø 86, ET 26

LED

2,7W

warm
WHITE

330lm



Ø 75



IP44



RECESSED



Ø 86



99265



99267



99265 FUEVA 5

surface-mounted light; steel, white / plastic, white
 Aufbauleuchte; Stahl, weiss / Kunststoff, weiss
 luminaire en saillie; acier, blanc / plastique, blanc

H 28, Ø 285



20,5W 2400lm

99267 FUEVA 5

surface-mounted light; steel, black / plastic, white
 Aufbauleuchte; Stahl, schwarz / Kunststoff, weiss
 luminaire en saillie; acier, noir / plastique, blanc

H 28, Ø 285



20,5W 2400lm

99266 FUEVA 5

surface-mounted light; steel, chrome / plastic, white
 Aufbauleuchte; Stahl, chrom / Kunststoff, weiss
 luminaire en saillie; acier, chrome / plastique, blanc

H 28, Ø 285



20,5W 2400lm



9 002759 992651



9 002759 992675



9 002759 992668





99266

LED





99268



99271



99268 FUEVA 5

surface-mounted light; steel, white / plastic, white
 Aufbauleuchte; Stahl, weiss / Kunststoff, weiss
 luminaire en saillie; acier, blanc / plastique, blanc

L 285, B 285, H 30



20,5W 2400lm

99271 FUEVA 5

surface-mounted light; steel, black / plastic, white
 Aufbauleuchte; Stahl, schwarz / Kunststoff, weiss
 luminaire en saillie; acier, noir / plastique, blanc

L 285, B 285, H 30



20,5W 2400lm

99269 FUEVA 5

surface-mounted light; steel, chrome / plastic, white
 Aufbauleuchte; Stahl, chrom / Kunststoff, weiss
 luminaire en saillie; acier, chrome / plastique, blanc

L 285, B 285, H 30



20,5W 2400lm



9 002759 992682



9 002759 992712



9 002759 992699

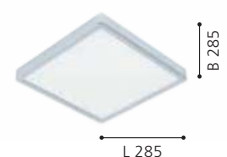



99269

LED





96541

LED



96542

LED



96544

LED

96541 ROMENDO 1

wall light; steel, chrome / plastic, clear, satined
Wandleuchte; Stahl, chrom / Kunststoff, klar, satiniert
applique; acier, chrome / plastique, transparent, satiné

L 70, H 155, A 120

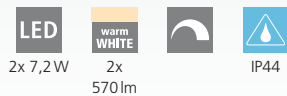

96542 ROMENDO 1

wall light; steel, chrome / plastic, clear, satined
Wandleuchte; Stahl, chrom / Kunststoff, klar, satiniert
applique; acier, chrome / plastique, transparent, satiné

L 300, H 70, A 125

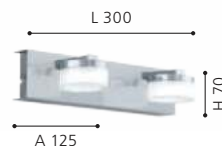
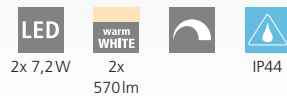

96544 ROMENDO 1

ceiling light; steel, chrome / plastic, clear, satined
Deckenleuchte; Stahl, chrom / Kunststoff, klar, satiniert
plafonnier; acier, chrome / plastique, transparent, satiné

L 320, B 320, H 70

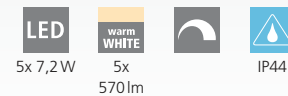



ROMENDO 1

These luminaires are dimmable.

Diese Leuchten sind dimmbar.

Ces luminaires sont graduables.

96543 ROMENDO 1

wall light; steel, chrome / plastic, clear, satined
Wandleuchte; Stahl, chrom / Kunststoff, klar, satiniert
applique; acier, chrome / plastique, transparent, satiné

L 450, H 70, A 125

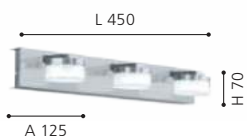
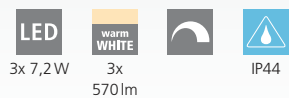

96543

LED



97718



97719



99692



97718 SIDERNO

mirror light; steel, chrome / plastic, satiné
Spiegelleuchte; Stahl, chrom / Kunststoff, satiniert
applique pour miroir; acier, chrome / plastique, satiné

L 350, B 60, A 55



8,3W 900lm

97719 SIDERNO

mirror light; steel, chrome / plastic, satiné
Spiegelleuchte; Stahl, chrom / Kunststoff, satiniert
applique pour miroir; acier, chrome / plastique, satiné

L 580, B 60, A 65



16W 1800lm

99692 SANIA 5

wall light; steel, satin nickel, white / plastic, satiné
Wandleuchte; Stahl, nickel-matt, weiss / Kunststoff, satiniert
applique; acier, nickel mat, blanc / plastique, satiné

L 620, H 80, A 90



26,5W 3200lm



9 002759 977184

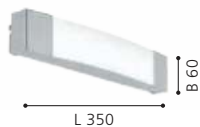

9 002759 977191



9 002759 996925

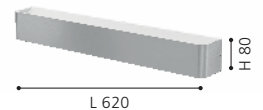



99691

LED

99691 SANIA 5

wall light; steel, black, white / plastic, satined
Wandleuchte; Stahl, schwarz, weiss / Kunststoff, satiniert
applique; acier, noir, blanc / plastique, satiné

L 620, H 80, A 90

LED

26,5W

warm
WHITE

3200lm



IP44



9 002759 996918

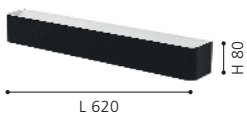



900615

LED



900616

LED



GEMILIANA

The LED profile of this luminaire can be swiveled for direct or indirect light.

Das LED-Profil dieser Leuchte ist schwenkbar für direktes oder indirektes Licht.

Le profil LED de cette luminaire peut être pivoté pour un éclairage direct ou indirect.



900475

LED

900615 GEMILIANA

mirror light; steel, black / plastic, white
Spiegelleuchte; Stahl, schwarz / Kunststoff, weiss
applique pour miroir; acier, noir / plastique, blanc

L 450, H 40, A 100



900616 GEMILIANA

mirror light; steel, chrome / plastic, white
Spiegelleuchte; Stahl, chrom / Kunststoff, weiss
applique pour miroir; acier, chrome / plastique, blanc

L 450, H 40, A 100



900475 VERDELLO

mirror light; plastic, black, brass / plastic, white
Spiegelleuchte; Kunststoff, schwarz, messing / Kunststoff, weiss
applique pour miroir; plastique, noir, laiton / plastique, blanc

L 600, B 60, H 105





900476



VERDELLO

This luminaire swivels up and down and has a CCT switch on the side.

Die Leuchte ist nach oben und unten schwenkbar und hat einen seitlichen CCT-Schalter.

Cette luminaire pivote de haut en bas et dispose d'un interrupteur CCT sur le côté.



900617



900618



900476 VERDELLO

mirror light; plastic, white, chrome / plastic, white
Spiegelleuchte; Kunststoff, weiss, chrom / Kunststoff, weiss
applique pour miroir; plastique, blanc, chrome / plastique, blanc

L 600, B 60, H 105



9 008606 244133

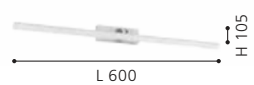

900617 ALCUDIA

mirror light; aluminium, steel, black / plastic, satiné
Spiegelleuchte; Alu, Stahl, schwarz / Kunststoff, satiniert
applique pour miroir; aluminium, acier, noir / plastique, satiné

L 420, H 30, A 60



9 008606 245147



900618 ALCUDIA

mirror light; aluminium, steel, chrome / plastic, satiné
Spiegelleuchte; Alu, Stahl, chrom / Kunststoff, satiniert
applique pour miroir; aluminium, acier, chrome / plastique, satiné

L 420, H 30, A 60



9 008606 245154



96938

LED



96938 CABUS

wall light; steel, chrome / plastic, satiné
Wandleuchte; Stahl, chrom / Kunststoff, satiniert
applique; acier, chrome / plastique, satiné

L 580, H 45, A 115

LED

4x 4,5W

warm
WHITE

1800lm



IP44





96937



94716



94617



96937 CABUS

wall light; steel, chrome / plastic, satined
Wandleuchte; Stahl, chrom / Kunststoff, satiniert
applique; acier, chrome / plastique, satiné

L 450, H 45, A 115



3x 4,5W 1350lm



9 002759 969370



94716 CALNOVA

wall light; steel, satin nickel / satin glass, white
Wandleuchte; Stahl, nickel-matt / Glas satiniert, weiss
applique; acier, nickel mat / verre satiné, blanc

L 600, B 50, A 85



14W 1900lm



9 002759 947163



94617 TORRETTA

mirror light; steel, satin nickel / plastic, white
Spiegelleuchte; Stahl, nickel-matt / Kunststoff, weiss
applique pour miroir; acier, nickel mat / plastique, blanc

L 600, B 40, A 75



14W 1900lm



9 002759 946173





TRAGACETE 1

These luminaires refer to an on / off button directly on the luminaire.

Diese Leuchten verfügen über einen Ein-/Ausschaltknopf direkt an der Leuchte.

Ces luminaires se réfèrent à un bouton marche / arrêt directement sur le luminaire.



99776

LED



99777

LED



99778

LED

99776 TRAGACETE 1

mirror light; plastic, steel, silver, chrome / plastic, white
Spiegelleuchte; Kunststoff, Stahl, silber, chrom / Kunststoff, weiss
applique pour miroir; plastique, acier, argent, chrome / plastique, blanc

L 450, B 45, H 45



7,5W



900lm



IP44



9 002759 997762



99777 TRAGACETE 1

mirror light; plastic, steel, silver, chrome / plastic, white
Spiegelleuchte; Kunststoff, Stahl, silber, chrom / Kunststoff, weiss
applique pour miroir; plastique, acier, argent, chrome / plastique, blanc

L 600, B 45, H 45



15,5W



1900lm



IP44



9 002759 997779



99778 TRAGACETE 1

mirror light; plastic, steel, silver, chrome / plastic, white
Spiegelleuchte; Kunststoff, Stahl, silber, chrom / Kunststoff, weiss
applique pour miroir; plastique, acier, argent, chrome / plastique, blanc

L 770, B 45, H 45



18,5W



2600lm



IP44



9 002759 997786





99339

LED

99339 TRAGACETE 1

mirror light; aluminium, silver, chrome / plastic, white
 Spiegelleuchte; Alu, silber, chrom / Kunststoff, weiss
 applique pour miroir; aluminium, argent, chrome / plastique, blanc

L 680, B 55, H 70

LED

15W

neutral
WHITE

1850lm



IP44



9 002759 993399

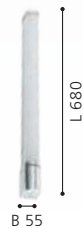

99339

This luminaire has a built-in socket.

Diese Leuchte verfügt über eine eingebaute Steckdose.

Cette luminaire a une douille intégrée.



DESIGN
HIGHLIGHT
DETAIL



94712



94713



94712 GITA 2

wall / ceiling light; cast metal, chrome / plastic, white
Wand- / Deckenleuchte; Metallguss, chrom / Kunststoff, weiss
applique / plafonnier; fonte métallique, chrome / plastique,
blanc

L 350, B 75, H 75



8,3W 900lm



9 002759 947125



94713 GITA 2

wall / ceiling light; cast metal, chrome / plastic, white
Wand- / Deckenleuchte; Metallguss, chrom / Kunststoff, weiss
applique / plafonnier; fonte métallique, chrome / plastique,
blanc

L 600, B 75, H 75



16W 1800lm



9 002759 947132



94714 GITA 2

wall / ceiling light; cast metal, chrome / plastic, white
Wand- / Deckenleuchte; Metallguss, chrom / Kunststoff, weiss
applique / plafonnier; fonte métallique, chrome / plastique,
blanc

L 900, B 75, H 75

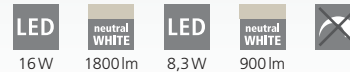

16W 1800lm 8,3W 900lm



9 002759 947149





94714

LED



94613

LED





94614



94612



94613 TABIANO

mirror light; steel, chrome / plastic, white
Spiegelleuchte; Stahl, chrom / Kunststoff, weiss
applique pour miroir; acier, chrome / plastique, blanc

L 605, H 70, A 130



3x 3,2W 900lm

94614 TABIANO

mirror light; steel, satin nickel / plastic, white
Spiegelleuchte; Stahl, nickel-matt / Kunststoff, weiss
applique pour miroir; acier, nickel mat / plastique, blanc

L 405, H 70, A 130



2x 3,2W 600lm

94612 TABIANO

mirror light; steel, chrome / plastic, white
Spiegelleuchte; Stahl, chrom / Kunststoff, weiss
applique pour miroir; acier, chrome / plastique, blanc

L 405, H 70, A 130



2x 3,2W 600lm



9 002759 946135



9 002759 946142



9 002759 946128



DESIGN
HIGHLIGHT
DETAIL



97081

LED



97082

LED

97081 VADUMI

wall light; plastic, chrome / plastic, white
Wandleuchte; Kunststoff, chrom / Kunststoff, weiss
applique; plastique, chrome / plastique, blanc

L 400, H 50, A 125



7,5W 850lm

97082 VADUMI

wall light; plastic, chrome / plastic, white
Wandleuchte; Kunststoff, chrom / Kunststoff, weiss
applique; plastique, chrome / plastique, blanc

L 600, H 50, A 125



11,5W 1350lm

97083 VADUMI

wall light; plastic, chrome / plastic, white
Wandleuchte; Kunststoff, chrom / Kunststoff, weiss
applique; plastique, chrome / plastique, blanc

L 780, H 50, A 125



15W 1750lm





97083

LED





98907

LED



98908

LED



99731

LED

98907 PANDELLA 1

mirror light; aluminium, plastic, black / plastic, white
Spiegelleuchte; Alu, Kunststoff, schwarz / Kunststoff, weiss
applique pour miroir; aluminium, plastique, noir / plastique, blanc

L 400, H 40, A 120



7,4W 900lm

98908 PANDELLA 1

mirror light; aluminium, plastic, black / plastic, white
Spiegelleuchte; Alu, Kunststoff, schwarz / Kunststoff, weiss
applique pour miroir; aluminium, plastique, noir / plastique, blanc

L 600, H 40, A 120



11W 1350lm

99731 PANDELLA 2

mirror light; aluminium, plastic, black / plastic, white
Spiegelleuchte; Alu, Kunststoff, schwarz / Kunststoff, weiss
applique pour miroir; aluminium, plastique, noir / plastique, blanc

L 600, H 40, A 120



11W 1400lm



9 002759 989071



9 002759 989088



9 002759 997311





98677

LED

98677 PANDELLA 1

mirror light; aluminium, plastic, black / plastic, white
 Spiegelleuchte; Alu, Kunststoff, schwarz / Kunststoff, weiss
 applique pour miroir; aluminium, plastique, noir / plastique, blanc

L 780, H 40, A 120



14W



1700lm



IP44



DESIGN
HIGHLIGHT
DETAIL



9 002759 986773





96064

LED



96065

LED



96066

LED

96064 PANDELLA 1

mirror light; aluminium, plastic, chrome, silver / plastic, white
Spiegelleuchte; Alu, Kunststoff, chrom, silber / Kunststoff, weiss
applique pour miroir; aluminium, plastique, chrome, argent /
plastique, blanc

L 400, H 40, A 120



7,4W



900lm



IP44



96065 PANDELLA 1

mirror light; aluminium, plastic, chrome, silver / plastic, white
Spiegelleuchte; Alu, Kunststoff, chrom, silber / Kunststoff, weiss
applique pour miroir; aluminium, plastique, chrome, argent /
plastique, blanc

L 600, H 40, A 120



11W



1350lm



IP44



96066 PANDELLA 1

mirror light; aluminium, plastic, chrome, silver / plastic, white
Spiegelleuchte; Alu, Kunststoff, chrom, silber / Kunststoff, weiss
applique pour miroir; aluminium, plastique, chrome, argent /
plastique, blanc

L 780, H 40, A 120



14W



1700lm



IP44



9 002759 960643

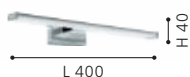

9 002759 960650



9 002759 960667





99297

LED



99297 PANDELLA 1

mirror light; aluminium, plastic, chrome, silver / plastic, white
Spiegelleuchte; Alu, Kunststoff, chrom, silber / Kunststoff, weiss
applique pour miroir; aluminium, plastique, chrome, argent /
plastique, blanc

L 1200, H 40, A 120



13,5W

1750lm

IP44



9 002759 992972

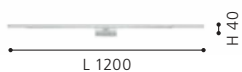

DESIGN
HIGHLIGHT
DETAIL



97059

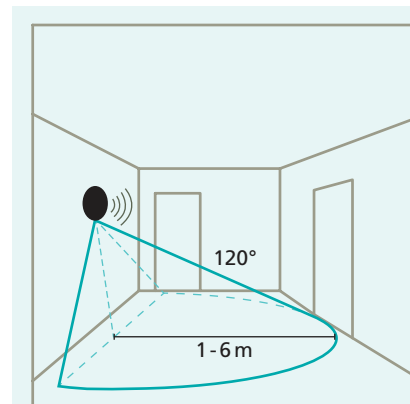

97059

This luminaire comes with an integrated motion sensor. The sensor is mounted invisibly behind the casing.

Diese Leuchte ist mit einem integrierten Bewegungssensor ausgestattet. Der Sensor ist unsichtbar hinter dem Gehäuse befestigt.

Ce luminaire vient avec un capteur de mouvement intégré. Le capteur est attaché invisiblement derrière le boîtier.

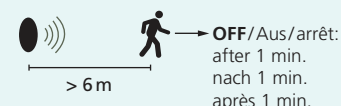
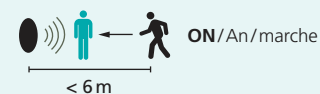

VINCHIO

These luminaires are delivered with a wiring and connection box that is 19.5 mm deep.

Diese Leuchten werden mit einer Verkabelungs- und Anschlussbox mit einer Tiefe von 19,5 mm geliefert.

Cette luminaires sont livré avec un boîtier de câblage et de connexion d'une profondeur de 19,5 mm.



98501



97059 PANDELLA 2

mirror light; plastic, silver, chrome / plastic, white
Spiegelleuchte; Kunststoff, silber, chrom / Kunststoff, weiss
applique pour miroir; plastique, argent, chrome / plastique, blanc

L 400, H 75, A 150



9 002759 970598



98501 VINCHIO

mirror light; steel, chrome / plastic, white
Spiegelleuchte; Stahl, chrom / Kunststoff, weiss
applique pour miroir; acier, chrome / plastique, blanc

L 400, H 50, A 140



9 002759 985011



98502 VINCHIO

mirror light; steel, chrome / plastic, white
Spiegelleuchte; Stahl, chrom / Kunststoff, weiss
applique pour miroir; acier, chrome / plastique, blanc

L 600, H 50, A 140



9 002759 985028





98502

LED





87219



87222



83406



83406 | 87219 | 87222

87219 PALMERA

wall light; steel, chrome / glass opal-matt, white
Wandleuchte; Stahl, chrom / Glas opal-matt, weiss
applique; acier, chrome / verre opale mat, blanc

L 460, A 110



87222 PALMERA

wall light; steel, satin nickel / glass opal-matt, white
Wandleuchte; Stahl, nickel-matt / Glas opal-matt, weiss
applique; acier, nickel mat / verre opale mat, blanc

L 460, A 110



83406 ZOLA

wall light; steel / glass opal-matt, white
Wandleuchte; Stahl / Glas opal-matt, weiss
applique; acier / verre opale mat, blanc

L 390, B 80



9 002759 872199



L 460



9 002759 872229



L 460



9 002759 834067



B 80



94987



85832

94987 BARI 1

mirror light; plastic, white / glass grooved, white
Spiegelleuchte; Kunststoff, weiss / Glas gerillt, weiss
applique pour miroir; plastique, blanc / verre rainuré, blanc

L 350, B 60, A 85



E14 2x 25W



9 002759 949877



85832 STICKER

mirror light; steel, chrome / glass opal-matt, white
Spiegelleuchte; Stahl, chrom / Glas opal-matt, weiss
applique pour miroir; acier, chrome / verre opale mat, blanc

L 70, H 115, A 95



E14 1x 40W



9 002759 858322



94987

This luminaire comes with an integrated power socket.

Diese Leuchte ist mit einer integrierten Steckdose ausgestattet.

Ce luminaire vient avec une prise de courant intégrée.

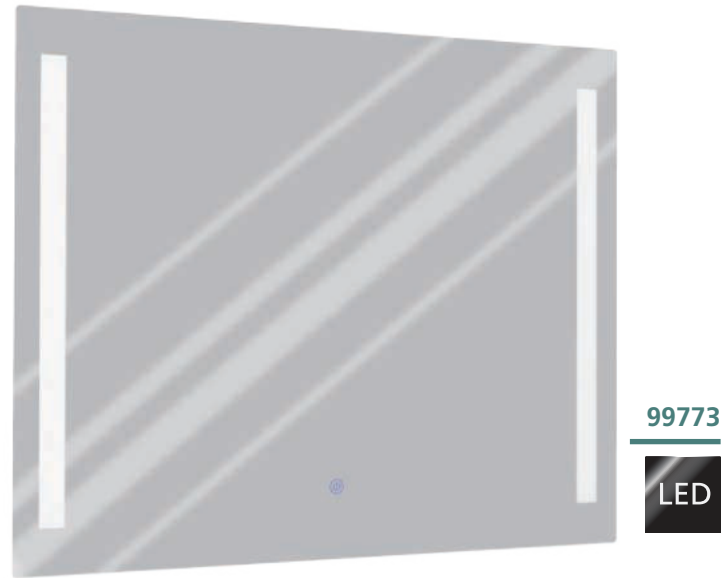
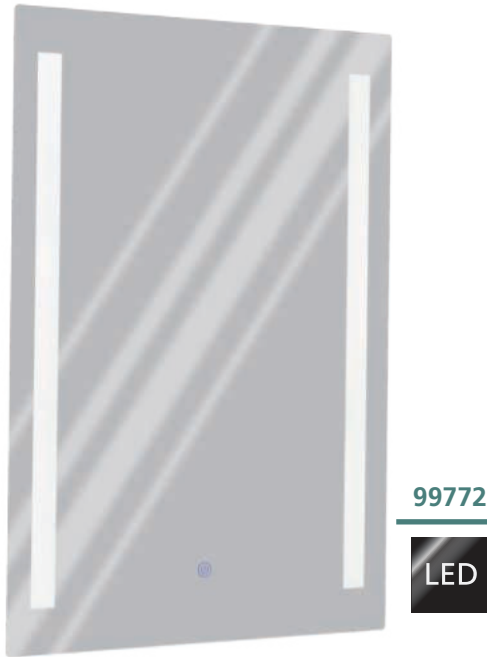

99772 BUENAVISTA

mirror light; aluminium, silver / mirror
Spiegelleuchte; Alu, silber / Spiegel
applique pour miroir; aluminium, argent / miroir

L 500, H 700, A 30

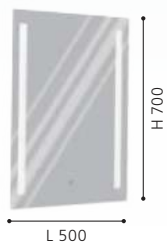
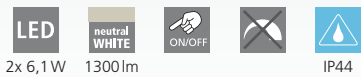

99773 BUENAVISTA

mirror light; aluminium, silver / mirror
Spiegelleuchte; Alu, silber / Spiegel
applique pour miroir; aluminium, argent / miroir

L 800, H 600, A 30

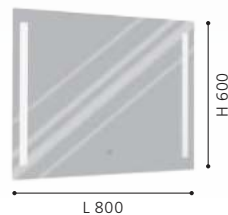
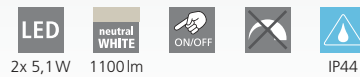

99774 BUENAVISTA

mirror light; aluminium, silver / mirror
Spiegelleuchte; Alu, silber / Spiegel
applique pour miroir; aluminium, argent / miroir

Ø 600, A 30

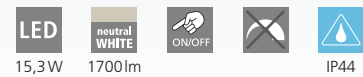



99774

LED





99838

LED

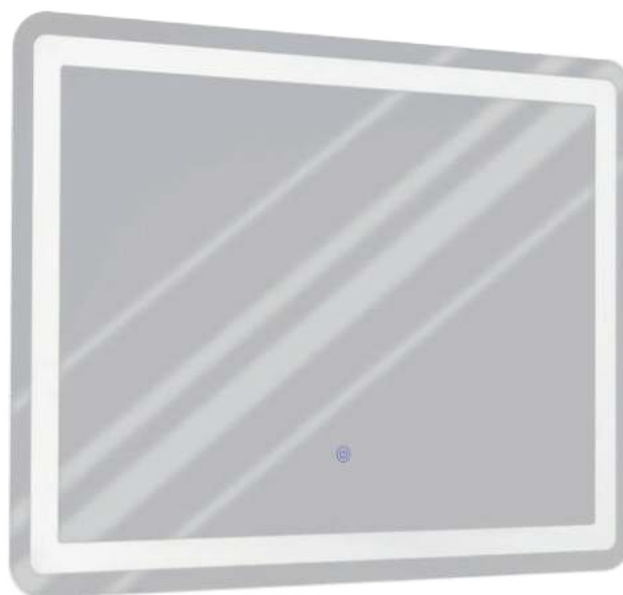

99839

LED

99838 BUENAVISTA 1

mirror light; aluminium, silver / mirror
Spiegelleuchte; Alu, silber / Spiegel
applique pour miroir; aluminium, argent / miroir

L 500, H 700, A 30



15,7W



1700lm



IP44



9 002759 998387



L 500

H 700

99839 BUENAVISTA 1

mirror light; aluminium, silver / mirror
Spiegelleuchte; Alu, silber / Spiegel
applique pour miroir; aluminium, argent / miroir

L 800, H 600, A 30



18,6W



2030lm



IP44



9 002759 998394

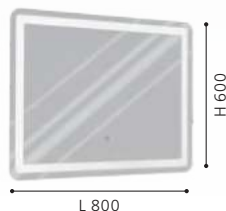

L 800

H 600

99853 BUENAVISTA 2

mirror light; aluminium, silver / mirror
Spiegelleuchte; Alu, silber / Spiegel
applique pour miroir; aluminium, argent / miroir

L 500, H 700, A 30



4x 7,1W



3000lm



IP44



9 002759 998530



L 500

H 700



99853



99854



99854 BUENAVISTA 2

mirror light; aluminium, silver / mirror
Spiegelleuchte; Alu, silber / Spiegel
applique pour miroir; aluminium, argent / miroir

L 800, H 600, A 30



4x 6,2 W



2600 lm



ON/OFF



IP44



9 002759 998547

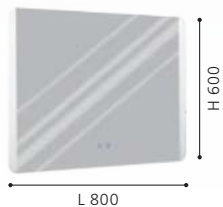

BUENAVISTA 2

The additional anti-fog function prevents the mirror from fogging up and ensures a clear view after showering.

Die zusätzliche Anti-Fog-Funktion verhindert das Beschlagen des Spiegels und sorgt für eine klare Sicht nach dem Duschen.

La fonction antibuée supplémentaire empêche le miroir de s'embuer et assure une vue dégagée après la douche.

SPOT & TRACK LUMINAIRES

SPOT- & SCHIENENLEUCHTEN
SPOTS & LUMINAIRES SUR RAIL

SYSTEMATIC LIGHTING

Our spot & track luminaires set specific highlights while optimally lighting your living rooms. No matter whether you prefer a modern or a traditional look – our range will fit any taste.

BELEUCHTUNG MIT SYSTEM

Mit unseren Spot- & Schienenleuchten setzen Sie gezielt Lichtakzente und sorgen zugleich für eine optimale Ausleuchtung Ihrer Wohnräume. Egal ob modern oder traditionell - unser Sortiment trifft jeden Geschmack.































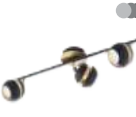







UN ÉCLAIRAGE AVEC SYSTÈME

Nos spots et nos luminaires sur rail vous permettent d'offrir des accents ponctuels de lumière et assurent parallèlement un éclairage optimal de vos pièces d'habitat. Qu'ils soient modernes ou traditionnels - notre gamme répond à tous les goûts.



OVERVIEW

SPOT & TRACK LUMINAIRES

							
TOWNSHEND 3 p. 660-663	BATALLAS p. 664-665	COTORRO p. 667	ESTEPERRA p. 669	VALBIANO p. 670	VILLABATE p. 671	POLLICA p. 672	BERREGAS p. 674
							
CONSACA p. 676	CASIBARE p. 678	COSWARTH p. 680	CAROVIGNO p. 682	SAMBATELLO p. 684-687	TABILLANO p. 688	ZAPATA 1 p. 690	ZAPATA p. 693
							
SERAS 1 p. 694-695	SERAS p. 696-697, 700-701	SERAS 2 p. 698-699	DAKAR 1 p. 702-703	ENEA p. 704-705	BARNHAM p. 706-707	NOCITO p. 708-709	BIMEDA p. 710-713
							
LOCANDA p. 714	CAYUCA p. 717	SOREGO p. 718	VERGIANO p. 719	DAVIDA p. 720-721	DAVIDA 1 p. 722-723	SARRIA p. 724-727	CORBERA p. 728
							
TUKON 3 p. 730	ZERACO p. 731	ROTTELO p. 732-733	BUZZ-LED p. 734-739	MAGNUM-LED p. 740-741	MAGNUM LED p. 741	CABO 1 p. 742	VILANOVA p. 742-743
							
CARDILLIO 1 p. 744-745, 747	CARDILLIO 2 p. 746-747	SALTO p. 748-749					



This product is available in different colors and shapes./ Dieser Artikel ist in unterschiedlichen Farben und Formen verfügbar.
Cet article est disponible en différentes couleurs et formes.





33169 TOWNSHEND 3

spot; wood, steel, brown, white
 Spot; Holz, Stahl, braun, weiss
 spot; bois, acier, marron, blanc

L 300, B 50



E27

2x 60W

33171 TOWNSHEND 3

spot; wood, steel, brown, white
 Spot; Holz, Stahl, braun, weiss
 spot; bois, acier, marron, blanc

L 480, B 50



E27

3x 60W

33172 TOWNSHEND 3

spot; wood, steel, brown, white
 Spot; Holz, Stahl, braun, weiss
 spot; bois, acier, marron, blanc

L 630, B 50



E27

4x 60W

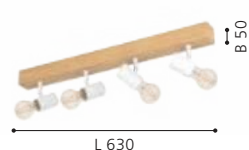
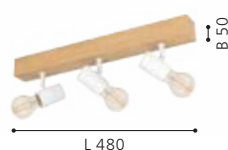
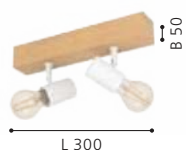



33172



33168

33168 TOWNSHEND 3

spot; wood, steel, brown, white
 Spot; Holz, Stahl, braun, weiss
 spot; bois, acier, marron, blanc

L 165, B 50



E27



1x 10W



9 002759 331689

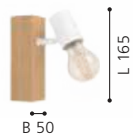



98112 TOWNSHEND 3

spot; wood, steel, brown, black
 Spot; Holz, Stahl, braun, schwarz
 spot; bois, acier, marron, noir

L 300, B 50



98113 TOWNSHEND 3

spot; wood, steel, brown, black
 Spot; Holz, Stahl, braun, schwarz
 spot; bois, acier, marron, noir

L 480, B 50



98114 TOWNSHEND 3

spot; wood, steel, brown, black
 Spot; Holz, Stahl, braun, schwarz
 spot; bois, acier, marron, noir

L 630, B 50

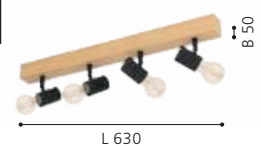
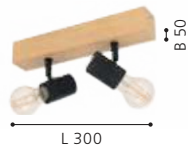



98114



98111

98111 TOWNSHEND 3

spot; wood, steel, brown, black
 Spot; Holz, Stahl, braun, schwarz
 spot; bois, acier, marron, noir

L 165, B 50



E27



1x 10W



9 002759 981112





99488



99489



99491



99488 BATALLAS

spot; wood, steel, brown, black / fabric, black, white
Spot; Holz, Stahl, braun, schwarz / Textil, schwarz, weiss
spot; bois, acier, marron, noir / tissu, noir, blanc

L 100, H 170, A 205



E27



1x 10W

99489 BATALLAS

spot; wood, steel, brown, black / fabric, black, white
Spot; Holz, Stahl, braun, schwarz / Textil, schwarz, weiss
spot; bois, acier, marron, noir / tissu, noir, blanc

L 300, B 50



E27



2x 10W

99491 BATALLAS

spot; wood, steel, brown, black / fabric, black, white
Spot; Holz, Stahl, braun, schwarz / Textil, schwarz, weiss
spot; bois, acier, marron, noir / tissu, noir, blanc

L 480, B 50



E27



3x 10W



9 002759 994884



9 002759 994891

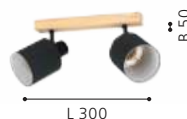

9 002759 994914





99492



99492 BATALLAS

spot; wood, steel, brown, black / fabric, black, white
Spot; Holz, Stahl, braun, schwarz / Textil, schwarz, weiss
spot; bois, acier, marron, noir / tissu, noir, blanc

L 630, B 50



E27



4x 10W



9 002759 994921



DESIGN
HIGHLIGHT
DETAIL





900433





900432



COTORRO



900434



900433 COTORRO

spot; wood, steel, brown, black
Spot; Holz, Stahl, braun, schwarz
spot; bois, acier, marron, noir

L 840, B 145, H 230



E27 3x 25W

900432 COTORRO

spot; wood, steel, brown, black
Spot; Holz, Stahl, braun, schwarz
spot; bois, acier, marron, noir

L 540, B 145, H 230



E27 2x 25W

900434 COTORRO

spot; wood, steel, brown, black
Spot; Holz, Stahl, braun, schwarz
spot; bois, acier, marron, noir

L 145, H 220, A 230



E27 1x 25W



9 008606 243891



L 840

H 230



9 008606 243884



L 540

H 230



9 008606 243907

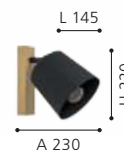

L 145

H 220

A 230



99278

DESIGN
HIGHLIGHT
DETAIL



99277



99276

99278 ESTEPERRA

spot; steel, black / fabric, black, gold
Spot; Stahl, schwarz / Textil, schwarz, gold
spot; acier, noir / tissu, noir, or

L 575, B 90



E27 3x 28W



9 002759 992781



99277 ESTEPERRA

spot; steel, black / fabric, black, gold
Spot; Stahl, schwarz / Textil, schwarz, gold
spot; acier, noir / tissu, noir, or

L 335, B 90



E27 2x 28W



9 002759 992774



99276 ESTEPERRA

spot; steel, black / fabric, black, gold
Spot; Stahl, schwarz / Textil, schwarz, gold
spot; acier, noir / tissu, noir, or

H 240, Ø 120



E27 1x 28W



9 002759 992767

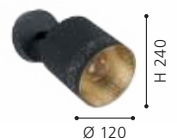

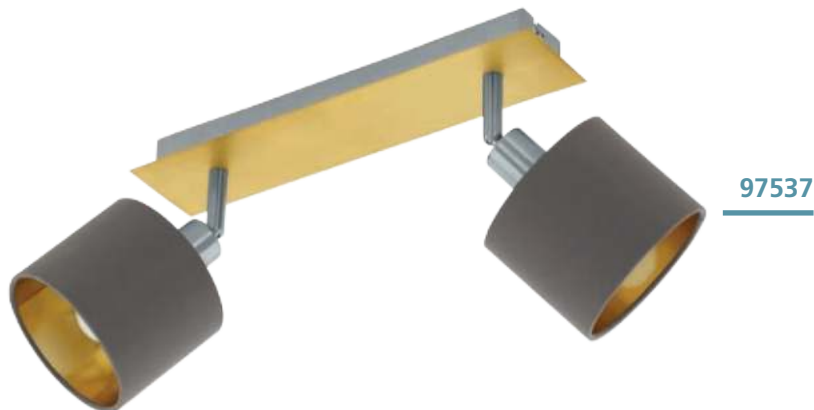

97536 VALBIANO

spot; steel, brushed brass, satin nickel / fabric, cappuccino, gold
 Spot; Stahl, messing-gebürstet, nickel-matt / Textil, cappuccino, gold
 spot; acier, laiton brossé, nickel mat / tissu, cappuccino, or

L 110, B 110



E14



1x 7W

97537 VALBIANO

spot; steel, brushed brass, satin nickel / fabric, cappuccino, gold
 Spot; Stahl, messing-gebürstet, nickel-matt / Textil, cappuccino, gold
 spot; acier, laiton brossé, nickel mat / tissu, cappuccino, or

L 320, B 70



E14



2x 7W

97538 VALBIANO

spot; steel, brushed brass, satin nickel / fabric, cappuccino, gold
 Spot; Stahl, messing-gebürstet, nickel-matt / Textil, cappuccino, gold
 spot; acier, laiton brossé, nickel mat / tissu, cappuccino, or

L 560, B 70



E14



3x 7W



9 002759 975364

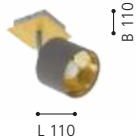

9 002759 975371

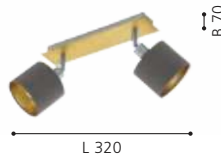

9 002759 975388

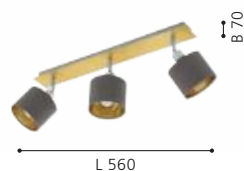



98139



98141

98139 VILLABATE

spot; steel, satin nickel / fabric, grey
Spot; Stahl, nickel-matt / Textil, grau
spot; acier, nickel mat / tissu, gris

L 335, B 90



E27 2x 10W

98141 VILLABATE

spot; steel, satin nickel / fabric, grey
Spot; Stahl, nickel-matt / Textil, grau
spot; acier, nickel mat / tissu, gris

L 575, B 90



E27 3x 10W



9 002759 981396



L 335

B 90



9 002759 981419



L 575

B 90



98624



98625

98624 POLLICA

spot; steel, black / glass vaporized, black-transparent
Spot; Stahl, schwarz / Glas bedampft, schwarz-transparent
spot; acier, noir / verre vaporisé, noir transparent

L 65, H 105



E14

1x 10W

98625 POLLICA

spot; steel, black / glass vaporized, black-transparent
Spot; Stahl, schwarz / Glas bedampft, schwarz-transparent
spot; acier, noir / verre vaporisé, noir transparent

L 365, B 165



E14

2x 28W

98626 POLLICA

spot; steel, black / glass vaporized, black-transparent
Spot; Stahl, schwarz / Glas bedampft, schwarz-transparent
spot; acier, noir / verre vaporisé, noir transparent

L 640, B 220



E14

4x 28W



9 002759 986247



9 002759 986254



9 002759 986261





98626





99052



99053

99052 BERREGAS

spot; steel, black, chrome / glass vaporized, black-transparent
 Spot; Stahl, schwarz, chrom / Glas bedampft, schwarz-transparent
 spot; acier, noir, chrome / verre vaporisé, noir transparent

Ø 110



E27

1x 28W

99053 BERREGAS

spot; steel, black, chrome / glass vaporized, black-transparent
 Spot; Stahl, schwarz, chrom / Glas bedampft, schwarz-transparent
 spot; acier, noir, chrome / verre vaporisé, noir transparent

L 440, B 110



E27

2x 40W

99054 BERREGAS

spot; steel, black, chrome / glass vaporized, black-transparent
 Spot; Stahl, schwarz, chrom / Glas bedampft, schwarz-transparent
 spot; acier, noir, chrome / verre vaporisé, noir transparent

L 775, B 110



E27

3x 40W



9 002759 990527



9 002759 990534



9 002759 990541





99054



99711



CONSACA



99713

99711 CONSACA

spot; steel, black / glass vaporized, black-transparent
Spot; Stahl, schwarz / Glas bedampft, schwarz-transparent
spot; acier, noir / verre vaporisé, noir transparent

L 120, H 220, A 235



E27



1x 28W

99713 CONSACA

spot; steel, black / glass vaporized, black-transparent
Spot; Stahl, schwarz / Glas bedampft, schwarz-transparent
spot; acier, noir / verre vaporisé, noir transparent

L 780, H 205, A 235



E27



4x 40W

99712 CONSACA

spot; steel, black / glass vaporized, black-transparent
Spot; Stahl, schwarz / Glas bedampft, schwarz-transparent
spot; acier, noir / verre vaporisé, noir transparent

L 340, H 205, A 235



E27



2x 40W



9 002759 997113



9 002759 997137



9 002759 997120





99712



99517



99518

99517 CASIBARE

spot; steel, black
Spot; Stahl, schwarz
spot; acier, noir

L 120, H 185, A 190



E27



1x 28W



9 002759 995171



99518 CASIBARE

spot; steel, black
Spot; Stahl, schwarz
spot; acier, noir

L 335, H 175, A 180



E27



2x 28W



9 002759 995188



99519 CASIBARE

spot; steel, black
Spot; Stahl, schwarz
spot; acier, noir

L 575, H 175, A 180



E27



3x 28W



9 002759 995195





99519





99075



99076

99075 COSWARTH

spot; steel, wood, anthracite, cream-white, brown
 Spot; Stahl, Holz, anthrazit, creme-weiss, braun
 spot; acier, bois, gris anthracite, blanc crème, marron

L 480, B 140, H 240



E27



2x 40W

99076 COSWARTH

spot; steel, wood, anthracite, cream-white, brown
 Spot; Stahl, Holz, anthrazit, creme-weiss, braun
 spot; acier, bois, gris anthracite, blanc crème, marron

L 670, B 140, H 240



E27



3x 40W

99074 COSWARTH

spot; steel, wood, anthracite, cream-white, brown
 Spot; Stahl, Holz, anthrazit, creme-weiss, braun
 spot; acier, bois, gris anthracite, blanc crème, marron

L 140, H 200



E27



1x 25W



9 002759 990756



L 480



9 002759 990763



L 670



9 002759 990749



L 140



99074





98621



98623

98621 CAROVIGNO

spot; steel, black
Spot; Stahl, schwarz
spot; acier, noir

L 65, H 105



E14

1x 28W

98623 CAROVIGNO

spot; steel, black
Spot; Stahl, schwarz
spot; acier, noir

L 640, B 150



E14

4x 40W

98622 CAROVIGNO

spot; steel, black
Spot; Stahl, schwarz
spot; acier, noir

L 365, B 150



E14

2x 40W



9 002759 986216



9 002759 986230



9 002759 986223



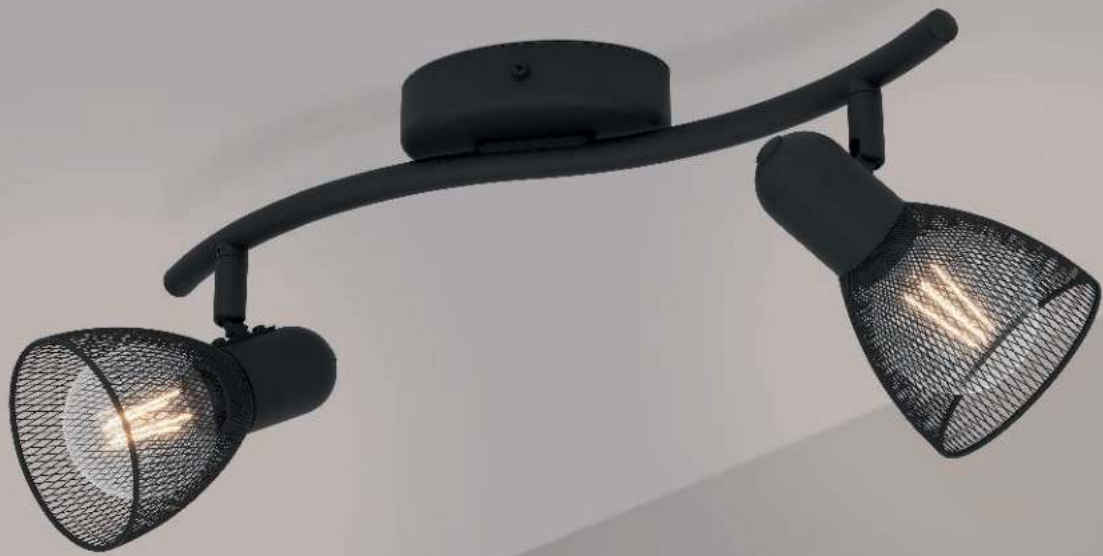

98622





98134



98135



98137

98134 SAMBATELLO

spot; wood, steel, brown, silver / steel, silver
 Spot; Holz, Stahl, braun, silber / Stahl, silber
 spot; bois, acier, marron, argent / acier, argent

L 150, H 220, A 240



E27



1x 40W



9 002759 981341

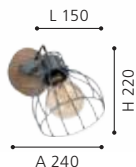

98135 SAMBATELLO

spot; wood, steel, brown, silver / steel, silver
 Spot; Holz, Stahl, braun, silber / Stahl, silber
 spot; bois, acier, marron, argent / acier, argent

L 335, B 90



E27



2x 40W



9 002759 981358

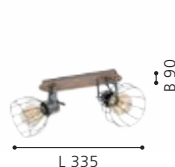

98137 SAMBATELLO

spot; wood, steel, brown, silver / steel, silver
 Spot; Holz, Stahl, braun, silber / Stahl, silber
 spot; bois, acier, marron, argent / acier, argent

L 795, B 90



E27



4x 40W



9 002759 981372





98136

98136 SAMBATELLO

spot; wood, steel, brown, silver / steel, silver
Spot; Holz, Stahl, braun, silber / Stahl, silber
spot; bois, acier, marron, argent / acier, argent

L 575, B 90



E27



3x 40W



9 002759 981365





900382



900383



900384

900382 SAMBATELLO

spot; steel, wood, black, brushed brass
 Spot; Stahl, Holz, schwarz, messing-gebürstet
 spot; acier, bois, noir, laiton brossé

L 260, B 150, H 220



E27 1x 40W

900383 SAMBATELLO

spot; steel, wood, black, brushed brass
 Spot; Stahl, Holz, schwarz, messing-gebürstet
 spot; acier, bois, noir, laiton brossé

L 480, B 280, H 260



E27 2x 40W

900384 SAMBATELLO

spot; steel, wood, black, brushed brass
 Spot; Stahl, Holz, schwarz, messing-gebürstet
 spot; acier, bois, noir, laiton brossé

L 700, B 280, H 260



E27 3x 40W



9 008606 243631

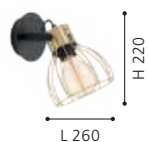

9 008606 243648

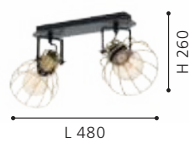

9 008606 243655





98763 TABILLANO

spot; steel, black
Spot; Stahl, schwarz
spot; acier, noir

L 440, B 110



98764 TABILLANO

spot; steel, black
Spot; Stahl, schwarz
spot; acier, noir

L 775, B 110



98762 TABILLANO

spot; steel, black
Spot; Stahl, schwarz
spot; acier, noir

Ø 110





98762





32765

LED



32767

LED

32765 ZAPATA 1

spot; steel, black / glass, amber
Spot; Stahl, schwarz / Glas, amber
spot; acier, noir / verre, ambre

Ø 60



G9



1x 3W



1x
320lm

32767 ZAPATA 1

spot; steel, black / glass, amber
Spot; Stahl, schwarz / Glas, amber
spot; acier, noir / verre, ambre

L 635, B 65



G9



4x 3W



4x
320lm

32766 ZAPATA 1

spot; steel, black / glass, amber
Spot; Stahl, schwarz / Glas, amber
spot; acier, noir / verre, ambre

L 360, B 65



G9



2x 3W



2x
320lm



9 002759 327651



9 002759 327675



9 002759 327668





32766

LED



95547

LED



95546

LED



95545

LED

DESIGN
HIGHLIGHT
DETAIL



95547 ZAPATA

spot; steel, copper / satin glass, white
Spot; Stahl, kupfer / Glas satiniert, weiss
spot; acier, cuivre / verre satiné, blanc

L 515, B 65

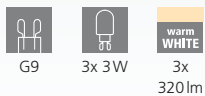

95546 ZAPATA

spot; steel, copper / satin glass, white
Spot; Stahl, kupfer / Glas satiniert, weiss
spot; acier, cuivre / verre satiné, blanc

L 360, B 65

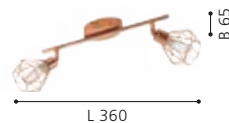
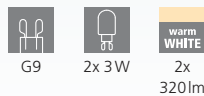

95545 ZAPATA

spot; steel, copper / satin glass, white
Spot; Stahl, kupfer / Glas satiniert, weiss
spot; acier, cuivre / verre satiné, blanc

Ø 60

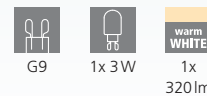



98393

LED



98394

LED



98396

LED

98393 SERAS 1

spot; steel, white
Spot; Stahl, weiss
spot; acier, blanc

Ø 100



GU10



1x 3W



1x
250lm

98394 SERAS 1

spot; steel, white
Spot; Stahl, weiss
spot; acier, blanc

L 370, B 65



GU10



2x 3W



2x
250lm

98396 SERAS 1

spot; steel, white
Spot; Stahl, weiss
spot; acier, blanc

L 770, B 65



GU10



4x 3W



4x
250lm



9 002759 983932



Ø 100



9 002759 983949



L 370



9 002759 983963



L 770



98395

LED

98395 SERAS 1

spot; steel, white
Spot; Stahl, weiss
spot; acier, blanc

L 595, B 65



GU10



3x 3W



warm
WHITE

3x
250lm



9 002759 983956





96552

LED



DESIGN
HIGHLIGHT
DETAIL



96552 SERAS

spot; steel, nickel-antique, creme
Spot; Stahl, nickel-antik, creme
spot; acier, nickel antique, crème

Ø 100



GU10



1x 3W



1x
warm
WHITE
250lm



9 002759 965525



INCL.

Ø 100





96553

LED



96554

LED



96555

LED

96553 SERAS

spot; steel, nickel-antique, creme
Spot; Stahl, nickel-antik, creme
spot; acier, nickel antique, crème

L 370, B 65

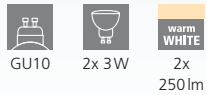

96554 SERAS

spot; steel, nickel-antique, creme
Spot; Stahl, nickel-antik, creme
spot; acier, nickel antique, crème

L 595, B 65

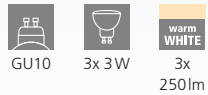

96555 SERAS

spot; steel, nickel-antique, creme
Spot; Stahl, nickel-antik, creme
spot; acier, nickel antique, crème

L 770, B 65

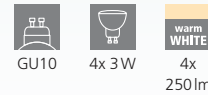

9 002759 965532



9 002759 965549



9 002759 965556





98398

LED



98397

LED

98398 SERAS 2

spot; steel, black
Spot; Stahl, schwarz
spot; acier, noir

L 370, B 65



GU10



2x 3W



warm
WHITE

2x

250lm



9 002759 983987





98399

LED



98408

LED

98397 SERAS 2

spot; steel, black
Spot; Stahl, schwarz
spot; acier, noir

Ø 100

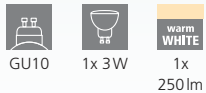

98399 SERAS 2

spot; steel, black
Spot; Stahl, schwarz
spot; acier, noir

L 595, B 65

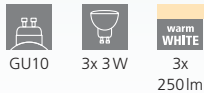

98408 SERAS 2

spot; steel, black
Spot; Stahl, schwarz
spot; acier, noir

L 770, B 65

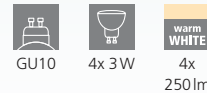



900169

LED



900171

LED



900173

LED

900169 SERAS

spot; steel, brushed brass, gold
Spot; Stahl, messing-gebürstet, gold
spot; acier, laiton brossé, or

Ø 100



GU10



1x 3W



1x
warm
WHITE
250lm

900171 SERAS

spot; steel, brushed brass, gold
Spot; Stahl, messing-gebürstet, gold
spot; acier, laiton brossé, or

L 370, B 65



GU10



2x 3W



2x
warm
WHITE
250lm

900173 SERAS

spot; steel, brushed brass, gold
Spot; Stahl, messing-gebürstet, gold
spot; acier, laiton brossé, or

L 770, B 65



GU10



4x 3W



4x
warm
WHITE
250lm



9 008606 235643



Ø 100



9 008606 235650



L 370



9 008606 235674



L 770



900172

LED

900172 SERAS

spot; steel, brushed brass, gold
Spot; Stahl, messing-gebürstet, gold
spot; acier, laiton brossé, or

L 595, B 65



GU10



3x 3W



warm
WHITE
3x
250lm



9 008606 235667

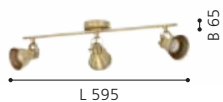



88472

DESIGN
HIGHLIGHT
DETAIL



88473



88472 DAKAR 1

spot; steel, satin nickel / glass wiping technique, white
Spot; Stahl, nickel-matt / Glas Wischtechnik, weiss
spot; acier, nickel mat / technique de verre essuyé, blanc

L 105, B 65



E14



1x 25W

88473 DAKAR 1

spot; steel, satin nickel / glass wiping technique, white
Spot; Stahl, nickel-matt / Glas Wischtechnik, weiss
spot; acier, nickel mat / technique de verre essuyé, blanc

L 370, B 100



E14



2x 40W



9 002759 884727



L 105



9 002759 884734



L 370

B 100



88474



88475

88474 DAKAR 1

spot; steel, satin nickel / glass wiping technique, white
 Spot; Stahl, nickel-matt / Glas Wischtechnik, weiss
 spot; acier, nickel mat / technique de verre essuyé, blanc

L 650, B 100



E14 4x 40W



9 002759 88474 1



88475 DAKAR 1

spot; steel, satin nickel / glass wiping technique, white
 Spot; Stahl, nickel-matt / Glas Wischtechnik, weiss
 spot; acier, nickel mat / technique de verre essuyé, blanc

Ø 295



E14 3x 40W



9 002759 88475 8





90984



90986



90985

90984 ENEA

spot; steel, satin nickel / satin glass, white
Spot; Stahl, nickel-matt / Glas satiniert, weiss
spot; acier, nickel mat / verre satiné, blanc

L 300, B 70



E14

2x 40W

90986 ENEA

spot; steel, satin nickel / satin glass, white
Spot; Stahl, nickel-matt / Glas satiniert, weiss
spot; acier, nickel mat / verre satiné, blanc

Ø 265



E14

3x 40W

90985 ENEA

spot; steel, satin nickel / satin glass, white
Spot; Stahl, nickel-matt / Glas satiniert, weiss
spot; acier, nickel mat / verre satiné, blanc

L 500, B 70



E14

3x 40W



9 002759 909840



9 002759 909864



9 002759 909857

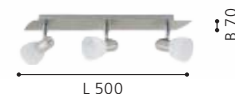



90982

90982 ENEA

spot; steel, satin nickel / satin glass, white
Spot; Stahl, nickel-matt / Glas satiniert, weiss
spot; acier, nickel mat / verre satiné, blanc

L 190, B 70



E14



1x 25W



9 002759 909826





94585 BARNHAM

spot; steel, black, copper
Spot; Stahl, schwarz, kupfer
spot; acier, noir, cuivre

L 395, B 70

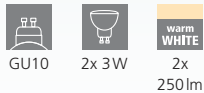

94586 BARNHAM

spot; steel, black, copper
Spot; Stahl, schwarz, kupfer
spot; acier, noir, cuivre

L 585, B 70

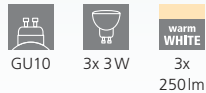

94587 BARNHAM

spot; steel, black, copper
Spot; Stahl, schwarz, kupfer
spot; acier, noir, cuivre

L 780, B 70

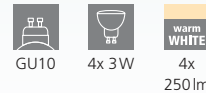



94587

LED



94584

LED

94584 BARNHAM

spot; steel, black, copper
 Spot; Stahl, schwarz, kupfer
 spot; acier, noir, cuivre

L 165, B 70



GU10



1x 3W



1x
 warm
 WHITE
 250lm



9 002759 945848



INCL.



B 70

L 165



95482

LED



95483

LED



95485

LED

95482 NOCITO

spot; steel, black, gold
Spot; Stahl, schwarz, gold
spot; acier, noir, or

Ø 110



GU10



1x 3W



1x
warm
WHITE
250lm

95483 NOCITO

spot; steel, black, gold
Spot; Stahl, schwarz, gold
spot; acier, noir, or

L 360, B 105



GU10



2x 3W



2x
warm
WHITE
250lm

95485 NOCITO

spot; steel, black, gold
Spot; Stahl, schwarz, gold
spot; acier, noir, or

L 760, B 105



GU10



4x 3W



4x
warm
WHITE
250lm



9 002759 954826



Ø 110



9 002759 954833



9 002759 954857





95484

LED

95484 NOCITO

spot; steel, black, gold
Spot; Stahl, schwarz, gold
spot; acier, noir, or

L 585, B 105



GU10



3x 3W



warm
WHITE
3x
250lm



9 002759 954840



DESIGN
HIGHLIGHT
DETAIL



31001

LED



31003

LED



31004

LED

31001 BIMEDA

spot; steel, white, chrome
Spot; Stahl, weiss, chrom
spot; acier, blanc, chrome

Ø 70



GU10



1x 2,8W



1x
250lm

31003 BIMEDA

spot; steel, white, chrome
Spot; Stahl, weiss, chrom
spot; acier, blanc, chrome

L 290, H 345



GU10



3x 2,8W



3x
250lm

31004 BIMEDA

spot; steel, white, chrome
Spot; Stahl, weiss, chrom
spot; acier, blanc, chrome

L 640, B 100



GU10



4x 2,8W



4x
250lm



9 002759 310011



Ø 70



9 002759 310035



L 290

H 345



9 002759 310042



L 640

B 100



31002

LED

31002 BIMEDA

spot; steel, white, chrome
Spot; Stahl, weiss, chrom
spot; acier, blanc, chrome

L 365, B 100



GU10



2x 2,8W



warm
WHITE
2x
250lm



9 002759 310028



INCL.





31005

LED



DESIGN
HIGHLIGHT
DETAIL

31005 BIMEDA

spot; steel, nickel-nero, chrome
Spot; Stahl, nickel-nero, chrom
spot; acier, nickel brillant, chrome

Ø 70



GU10



1x 2,8W



1x
warm
WHITE
250lm





31006 BIMEDA

spot; steel, nickel-nero, chrome
Spot; Stahl, nickel-nero, chrom
spot; acier, nickel brillant, chrome

L 365, B 100

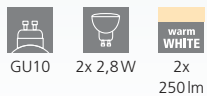

31007 BIMEDA

spot; steel, nickel-nero, chrome
Spot; Stahl, nickel-nero, chrom
spot; acier, nickel brillant, chrome

L 290, H 345

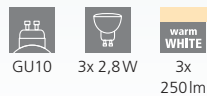

31008 BIMEDA

spot; steel, nickel-nero, chrome
Spot; Stahl, nickel-nero, chrom
spot; acier, nickel brillant, chrome

L 640, B 100

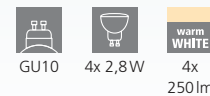

DESIGN
HIGHLIGHT
DETAIL



94251

LED

94251 LOCANDA

ceiling light; steel, satin nickel, chrome
Deckenleuchte; Stahl, nickel-matt, chrom
plafonnier; acier, nickel mat, chrome

L 700, B 660



GU10



5x 2,8W



5x
warm
WHITE
250lm



9 002759 942519



L 700

94252 LOCANDA

ceiling light; steel, white, chrome
Deckenleuchte; Stahl, weiss, chrom
plafonnier; acier, blanc, chrome

L 700, B 660



GU10



5x 2,8W



5x
warm
WHITE
250lm



9 002759 942526



L 700



94252

LED





900438

LED



900436

LED

DESIGN
HIGHLIGHT
DETAIL



900437

LED

900438 CAYUCA

spot; steel, black / wood, brown
Spot; Stahl, schwarz / Holz, braun
spot; acier, noir / bois, marron

L 580, B 100, H 120

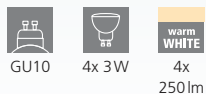

900436 CAYUCA

spot; steel, black / wood, brown
Spot; Stahl, schwarz / Holz, braun
spot; acier, noir / bois, marron

L 110, B 105, H 120

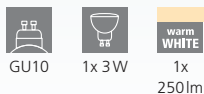

900437 CAYUCA

spot; steel, black / wood, brown
Spot; Stahl, schwarz / Holz, braun
spot; acier, noir / bois, marron

L 280, B 100, H 120

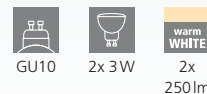

L 580



L 110



L 280



900331

LED



900332

LED



900333

LED

900331 SOREGO

spot; steel, black
Spot; Stahl, schwarz
spot; acier, noir

L 110, B 105, H 120



GU10



1x 3W



1x

250lm

900332 SOREGO

spot; steel, black
Spot; Stahl, schwarz
spot; acier, noir

L 280, B 100, H 120



GU10



2x 3W



2x

250lm

900333 SOREGO

spot; steel, black
Spot; Stahl, schwarz
spot; acier, noir

L 580, B 100, H 120



GU10



4x 3W



4x

250lm





97506



97507



97508

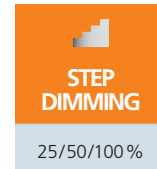

97506

97508

97507

97506 VERGIANO

spot; aluminium, steel, white, satin nickel
Spot; Alu, Stahl, weiss, nickel-matt
spot; aluminium, acier, blanc, nickel mat

L 70, H 165



GU10



1x 5W



1x
400lm



9 002759 975067



97507 VERGIANO

spot; aluminium, steel, white, satin nickel
Spot; Alu, Stahl, weiss, nickel-matt
spot; aluminium, acier, blanc, nickel mat

L 390, B 70



GU10



2x 5W



2x
400lm



9 002759 975074



L 390

97508 VERGIANO

spot; aluminium, steel, white, satin nickel
Spot; Alu, Stahl, weiss, nickel-matt
spot; aluminium, acier, blanc, nickel mat

L 690, B 70



GU10



3x 5W



3x
400lm



9 002759 975081



L 690



92084

LED



92085

LED



92086

LED

92084 DAVIDA

spot; steel, chrome, white
Spot; Stahl, chrom, weiss
spot; acier, chrome, blanc

L 165, B 70



GU10



1x 4,6W



warm
WHITE

1x
400lm



L 165

B 70

92085 DAVIDA

spot; steel, chrome, white
Spot; Stahl, chrom, weiss
spot; acier, chrome, blanc

L 390, B 70



GU10



2x 4,6W



warm
WHITE

2x
400lm



B 70

L 390

92086 DAVIDA

spot; steel, chrome, white
Spot; Stahl, chrom, weiss
spot; acier, chrome, blanc

L 580, B 70



GU10



3x 4,6W



warm
WHITE

3x
400lm



B 70

L 580



9 002759 920845



9 002759 920852



9 002759 920869





92087

LED

92087 DAVIDA

spot; steel, chrome, white
Spot; Stahl, chrom, weiss
spot; acier, chrome, blanc

L 780, B 70



GU10



4x 4,6 W



4x
warm
WHITE
400lm



9 002759 920876

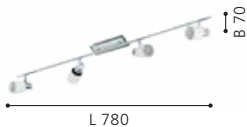



30833

LED



30832

LED

30832 DAVIDA 1

spot; steel, nickel-nero
Spot; Stahl, nickel-nero
spot; acier, nickel noir

L 165, B 70



GU10



1x 4,6W



1x
warm
WHITE
400lm



9 002759 308322



INCL.





30834

LED



30835

LED

30833 DAVIDA 1

spot; steel, nickel-nero
Spot; Stahl, nickel-nero
spot; acier, nickel noir

L 390, B 70

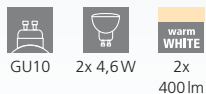

GU10 2x 4,6W 2x warm WHITE 400lm



9 002759 308339



L 390

B 70

30834 DAVIDA 1

spot; steel, nickel-nero
Spot; Stahl, nickel-nero
spot; acier, nickel noir

L 580, B 70

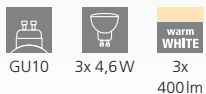

GU10 3x 4,6W 3x warm WHITE 400lm



9 002759 308346



L 580

B 70

30835 DAVIDA 1

spot; steel, nickel-nero
Spot; Stahl, nickel-nero
spot; acier, nickel noir

L 780, B 70

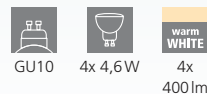

GU10 4x 4,6W 4x warm WHITE 400lm



9 002759 308353



L 780

B 70



94962

LED



94958

LED

94962 SARRIA

spot; steel, white, chrome
Spot; Stahl, weiss, chrom
spot; acier, blanc, chrome

L 240, H 260



GU10



4x 4,5W



4x

345lm





94959

LED



94961

LED

94958 SARRIA

spot; steel, white, chrome
Spot; Stahl, weiss, chrom
spot; acier, blanc, chrome

L 120, B 60

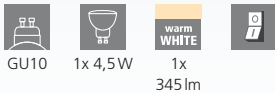

GU10 1x 4,5W 1x 345lm



9 002759 949587



94959 SARRIA

spot; steel, white, chrome
Spot; Stahl, weiss, chrom
spot; acier, blanc, chrome

L 300, B 70

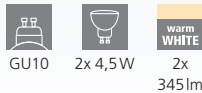

GU10 2x 4,5W 2x 345lm



9 002759 949594



94961 SARRIA

spot; steel, white, chrome
Spot; Stahl, weiss, chrom
spot; acier, blanc, chrome

L 460, B 70

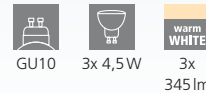

GU10 3x 4,5W 3x 345lm



9 002759 949617





94963



94966



94964



94963 SARRIA

spot; steel, black, chrome
Spot; Stahl, schwarz, chrom
spot; acier, noir, chrome

L 120, B 60

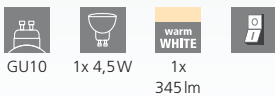

GU10 1x 4,5W 1x 345lm

94964 SARRIA

spot; steel, black, chrome
Spot; Stahl, schwarz, chrom
spot; acier, noir, chrome

L 300, B 70

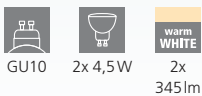

GU10 2x 4,5W 2x 345lm

94966 SARRIA

spot; steel, black, chrome
Spot; Stahl, schwarz, chrom
spot; acier, noir, chrome

L 240, H 260

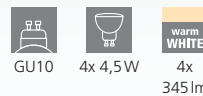

GU10 4x 4,5W 4x 345lm





94965

LED

94965 SARRIA

spot; steel, black, chrome
 Spot; Stahl, schwarz, chrom
 spot; acier, noir, chrome

L 460, B 70



GU10



3x 4,5W



warm
WHITE

3x
345 lm



9 002759 949655



INCL.



L 460

B 70



DESIGN
HIGHLIGHT
DETAIL



CORBERA

Designer spot series with special spot heads.

Spotsérie mit Spotköpfen in besonderem Design.

Série de spot avec des têtes de spot spéciales.

93672 CORBERA

spot; steel, plastic, chrome
Spot; Stahl, Kunststoff, chrom
spot; acier, plastique, chrome

L 120, B 60

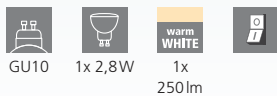

9 002759 936723

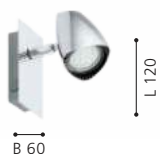

93673 CORBERA

spot; steel, plastic, chrome
Spot; Stahl, Kunststoff, chrom
spot; acier, plastique, chrome

L 390, B 70

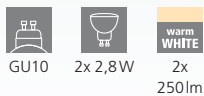

9 002759 936730



93674 CORBERA

spot; steel, plastic, chrome
Spot; Stahl, Kunststoff, chrom
spot; acier, plastique, chrome

L 585, B 70

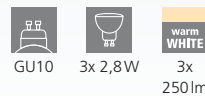

9 002759 936747





93674

LED



94145 TUKON 3

spot; steel, satin nickel
 Spot; Stahl, nickel-matt
 spot; acier, nickel mat

L 280, B 70

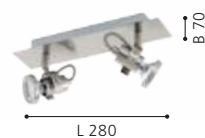
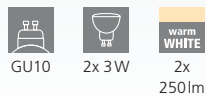

94146 TUKON 3

spot; steel, satin nickel
 Spot; Stahl, nickel-matt
 spot; acier, nickel mat

L 460, B 70

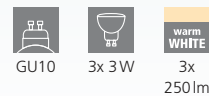



93679

LED

93679 ZERACO

spot; steel, plastic, satin nickel
 Spot; Stahl, Kunststoff, nickel-matt
 spot; acier, plastique, nickel mat

L 940, B 120



GU10



6x 4,6W



6x
 warm
 WHITE
 400lm

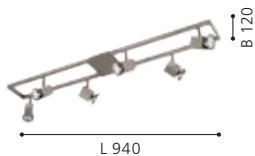



90915 ROTTELO

spot; steel, satin nickel, chrome
Spot; Stahl, nickel-matt, chrom
spot; acier, nickel mat, chrome

L 280, B 70

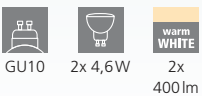

90914 ROTTELO

spot; steel, satin nickel, chrome
Spot; Stahl, nickel-matt, chrom
spot; acier, nickel mat, chrome

L 120, B 60

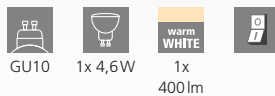

90916 ROTTELO

spot; steel, satin nickel, chrome
Spot; Stahl, nickel-matt, chrom
spot; acier, nickel mat, chrome

L 260, B 240

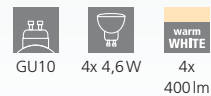



90917



90927



90917 ROTTELO

spot; steel, satin nickel, chrome
 Spot; Stahl, nickel-matt, chrom
 spot; acier, nickel mat, chrome

L 780, B 70

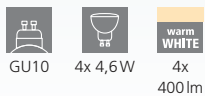

90927 ROTTELO

spot; steel, satin nickel, chrome
 Spot; Stahl, nickel-matt, chrom
 spot; acier, nickel mat, chrome

L 1160, B 70

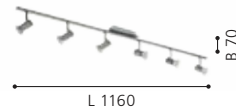
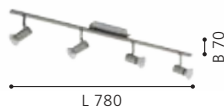
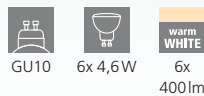



92595

LED



92596

LED



92597

LED

92595 BUZZ-LED

spot; steel, satin nickel
Spot; Stahl, nickel-matt
spot; acier, nickel mat

Ø 60



GU10



1x 2,8W



1x
warm
WHITE
250lm

92596 BUZZ-LED

spot; steel, satin nickel
Spot; Stahl, nickel-matt
spot; acier, nickel mat

L 285, B 65



GU10



2x 2,8W



2x
warm
WHITE
250lm

92597 BUZZ-LED

spot; steel, satin nickel
Spot; Stahl, nickel-matt
spot; acier, nickel mat

L 485, B 65



GU10



3x 2,8W



3x
warm
WHITE
250lm





92598

LED



92599

LED

92598 BUZZ-LED

spot; steel, satin nickel
Spot; Stahl, nickel-matt
spot; acier, nickel mat

L 685, B 65



GU10



4x 2,8W



warm
WHITE

4x
250lm

92599 BUZZ-LED

spot; steel, satin nickel
Spot; Stahl, nickel-matt
spot; acier, nickel mat

L 1050, B 65



GU10



6x 2,8W



warm
WHITE

6x
250lm



9 002759 925987



L 685



9 002759 925994

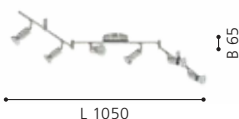

L 1050



32428

LED



32429

LED



32431

LED

32428 BUZZ-LED

spot; steel, black
Spot; Stahl, schwarz
spot; acier, noir

Ø 60



GU10



1x 2,8W



1x
warm
WHITE
250lm

32429 BUZZ-LED

spot; steel, black
Spot; Stahl, schwarz
spot; acier, noir

L 285, B 65



GU10



2x 2,8W



2x
warm
WHITE
250lm

32431 BUZZ-LED

spot; steel, black
Spot; Stahl, schwarz
spot; acier, noir

L 485, B 65



GU10



3x 2,8W



3x
warm
WHITE
250lm



9 002759 324285



Ø 60



9 002759 324292



L 285

B 65



9 002759 324315



L 485

B 65



32432

LED





32433

LED

32432 BUZZ-LED

spot; steel, black
Spot; Stahl, schwarz
spot; acier, noir



L 685, B 65

		
GU10	4x 2,8W	4x warm WHITE 250lm

32433 BUZZ-LED

spot; steel, black
Spot; Stahl, schwarz
spot; acier, noir

L 1050, B 65

		
GU10	6x 2,8W	6x warm WHITE 250lm



9 002759 324322

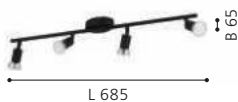

9 002759 324339





33184

LED



33185

LED



33186

LED

33184 BUZZ-LED

spot; steel, brushed brass
Spot; Stahl, messing-gebürstet
spot; acier, laiton brossé

Ø 60



GU10



1x 2,8W



1x
250lm

33185 BUZZ-LED

spot; steel, brushed brass
Spot; Stahl, messing-gebürstet
spot; acier, laiton brossé

L 285, B 65



GU10



2x 2,8W



2x
250lm

33186 BUZZ-LED

spot; steel, brushed brass
Spot; Stahl, messing-gebürstet
spot; acier, laiton brossé

L 485, B 65



GU10



3x 2,8W



3x
250lm



9 002759 331849



Ø 60



9 002759 331856



L 285

B 65



9 002759 331863



L 485

B 65



33187

LED

33187 BUZZ-LED

spot; steel, brushed brass
Spot; Stahl, messing-gebürstet
spot; acier, laiton brossé

L 685, B 65



GU10



4x 2,8W



warm
WHITE
4x
250lm



9 002759 331870

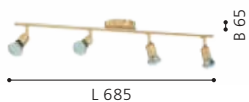



92641

LED



92642

LED



92643

LED

92641 MAGNUM-LED

spot; steel, satin nickel, chrome
Spot; Stahl, nickel-matt, chrom
spot; acier, nickel mat, chrome

Ø 70



GU10



1x 2,8W



1x
250lm



9 002759 926410



Ø 70

92642 MAGNUM-LED

spot; steel, satin nickel, chrome
Spot; Stahl, nickel-matt, chrom
spot; acier, nickel mat, chrome

L 330, B 105



GU10



2x 2,8W



2x
250lm



9 002759 926427



L 330

B 105

92643 MAGNUM-LED

spot; steel, satin nickel, chrome
Spot; Stahl, nickel-matt, chrom
spot; acier, nickel mat, chrome

L 255, H 295



GU10



3x 2,8W



3x
250lm



9 002759 926434



L 255

H 295



95824

LED



92644

LED



92645

LED

95824 MAGNUM LED

spot; steel, satin nickel, chrome
Spot; Stahl, nickel-matt, chrom
spot; acier, nickel mat, chrome

Ø 180



GU10



3x 2,8W



3x
250lm



9 002759 958244



Ø 180

92644 MAGNUM-LED

spot; steel, satin nickel, chrome
Spot; Stahl, nickel-matt, chrom
spot; acier, nickel mat, chrome

L 645, B 105



GU10



4x 2,8W



4x
250lm



9 002759 926441



L 645

92645 MAGNUM-LED

spot; steel, satin nickel, chrome
Spot; Stahl, nickel-matt, chrom
spot; acier, nickel mat, chrome

L 1050



GU10



6x 2,8W



6x
250lm



9 002759 926458



L 1050



93359

LED



93085

LED



93358

93359



94609

93085 CABO 1

wall / ceiling light; steel, chrome / satin glass, white, clear
Wand- / Deckenleuchte; Stahl, chrom / Glas satiniert, weiss, klar
applique / plafonnier; acier, chrome / verre satiné, blanc, transparent

H 100, Ø 290



GU10



4x 2,8W



4x
250lm



9 002759 930851



93359 VILANOVA

system; aluminium, steel, aluminium, chrome
System; Alu, Stahl, alu, chrom
système; aluminium, acier, aluminium, chrome

L 2000, H 200



GU10



5x 2,8W



5x
250lm



9 002759 933593



94609 VILANOVA

accessory; steel, satin nickel
Zubehör; Stahl, nickel-matt
accessoire; acier, nickel mat

L 395



9 002759 946098

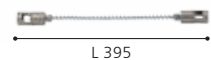



93358

LED

93358 VILANOVA

system; aluminium, steel, aluminium, chrome / glass, white, clear
 System; Alu, Stahl, alu, chrom / Glas, weiss, klar
 système; aluminium, acier, aluminium, chrome / verre, blanc, transparent

L 2000, H 200



GU10



5x 4,6W



5x
warm
WHITE
400lm



9 002759 933586



INCL.



L 2000

94609

Set to connect 93359 and 93358 tracks:

- > 250mm cable
- > 2 end parts
- > 1 straight connector for direct connection

Verbindungsset für 93359 und 93358 Schienen:

- > 250mm Kabel
- > 2 Endstücke
- > 1 Verbinder für eine direkte Verbindung

Set de connexion pour rails 93359 et 93358:

- > câble de 250mm
- > 2 pièces d'about
- > 1 connecteur pour une connexion directe

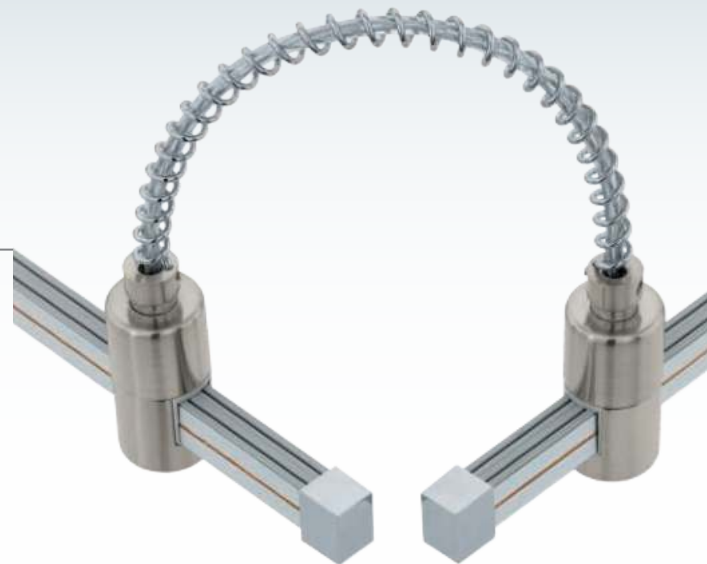



96182

LED



96178

LED



96179

LED

96182 CARDILLO 1

spot; aluminium, steel, aluminium, chrome / plastic, satiné
Spot; Alu, Stahl, alu, chrom / Kunststoff, satiniert
spot; aluminium, acier, aluminium, chrome / plastique, satiné

L 985, B 85

LED

warm
WHITE

LED

warm
WHITE



4x 3,2W 1760lm 2x 3,3W 800lm



9 002759 961824



96178 CARDILLO 1

spot; aluminium, steel, aluminium, chrome / plastic, satiné
Spot; Alu, Stahl, alu, chrom / Kunststoff, satiniert
spot; aluminium, acier, aluminium, chrome / plastique, satiné

L 225, B 65

LED

warm
WHITE

LED

warm
WHITE



1x 3,2W 440lm 1x 2,2W 260lm



9 002759 961787



96179 CARDILLO 1

spot; aluminium, steel, aluminium, chrome / plastic, satiné
Spot; Alu, Stahl, alu, chrom / Kunststoff, satiniert
spot; aluminium, acier, aluminium, chrome / plastique, satiné

L 390, B 85

LED

warm
WHITE

LED

warm
WHITE



2x 3,2W 880lm 1x 3,3W 400lm



9 002759 961794

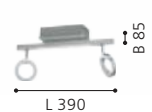



96181

LED



96183

LED



96181 CARDILLIO 1

spot; aluminium, steel, aluminium, chrome / plastic, satiné
Spot; Alu, Stahl, alu, chrom / Kunststoff, satiniert
spot; aluminium, acier, aluminium, chrome / plastique, satiné

L 690, B 85



3x 3,2W 1320lm 2x 3,3W 800lm



9 002759 961817



96183 CARDILLIO 1

spot; aluminium, steel, aluminium, chrome / plastic, satiné
Spot; Alu, Stahl, alu, chrom / Kunststoff, satiniert
spot; aluminium, acier, aluminium, chrome / plastique, satiné

L 1585, B 85



6x 3,2W 2640lm 3x 3,3W 1200lm



9 002759 961831



CARDILLIO 1

These luminaires have different lighting sources. Profil lights combined with spot heads create basic lighting as well as accent lighting.

Diese Leuchten verfügen über unterschiedliche Lichtquellen. Profilleuchten kombiniert mit Spotköpfen schaffen sowohl Grundlicht als auch Akzentbeleuchtung.

Ces luminaires ont des sources d'éclairage différentes. La combinaison entre un éclairage sur la base du produit et un spot vous permet d'avoir un éclairage général mais aussi directionnel.



900516

LED



900513

LED

900516 CARDILLIO 2

spot; aluminium, steel, black / plastic, satiné
 Spot; Alu, Stahl, schwarz / Kunststoff, satiniert
 spot; aluminium, acier, noir / plastique, satiné

L 985, B 85, H 175

LED warm WHITE LED warm WHITE

4x 3,2W 1600lm 2x 3,3W 720lm



9 008606 244454



L 985

900513 CARDILLIO 2

spot; aluminium, steel, black / plastic, satiné
 Spot; Alu, Stahl, schwarz / Kunststoff, satiniert
 spot; aluminium, acier, noir / plastique, satiné

L 225, B 65, H 165

LED warm WHITE LED warm WHITE

1x 3,2W 400lm 1x 2,2W 240lm



9 008606 244423



L 225



900514 CARDILLIO 2

spot; aluminium, steel, black / plastic, satiné
Spot; Alu, Stahl, schwarz / Kunststoff, satiniert
spot; aluminium, acier, noir / plastique, satiné

L 385, B 85, H 175



900515 CARDILLIO 2

spot; aluminium, steel, black / plastic, satiné
Spot; Alu, Stahl, schwarz / Kunststoff, satiniert
spot; aluminium, acier, noir / plastique, satiné

L 385, B 85, H 175



900839 CARDILLIO 1

spot; aluminium, steel, black / plastic, satiné
Spot; Alu, Stahl, schwarz / Kunststoff, satiniert
spot; aluminium, acier, noir / plastique, satiné

L 1585, B 85, H 200

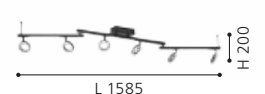



95629

LED



DESIGN
HIGHLIGHT
DETAIL

95629 SALTO

spot; steel, chrome / plastic, satiné
Spot; Stahl, chrom / Kunststoff, satiniert
spot; acier, chrome / plastique, satiné

L 360, B 120

LED

2x 5,4W

warm
WHITE

2x
640lm



9 002759 956295





95628

LED



95631

LED



95632

LED

95628 SALTO

spot; steel, chrome / plastic, satiné
Spot; Stahl, chrom / Kunststoff, satiniert
spot; acier, chrome / plastique, satiné

Ø 110



1x 5,4W

1x
640lm



9 002759 956288



95631 SALTO

spot; steel, chrome / plastic, satiné
Spot; Stahl, chrom / Kunststoff, satiniert
spot; acier, chrome / plastique, satiné

L 560, B 130



3x 5,4W

3x
640lm



9 002759 956318



95632 SALTO

spot; steel, chrome / plastic, satiné
Spot; Stahl, chrom / Kunststoff, satiniert
spot; acier, chrome / plastique, satiné

L 760, B 130



4x 5,4W

4x
640lm



9 002759 956325



CLIP & PLUG LUMINAIRES

KLEMM- & STECKERLEUCHTEN
LUMINAIRES À PINCE & SUR PRISE

LIGHT - VIRTUALLY ANYWHERE

Our clamping and plug-in luminaires inspire with their flexible uses. They serve as pleasant reading lamps or can be positioned for targeted highlighting.

LICHT - PRAKTISCH ÜBERALL

Unsere Klemm- und Steckerleuchten begeistern durch ihre flexible Verwendbarkeit. Sie dienen als angenehme Lesebeleuchtung oder können zur gezielten Lichtsetzung positioniert werden.



LA LUMIÈRE - PRATIQUE ET PARTOUT

Nos luminaires à pinces et à fiches ravissent de leurs possibilités flexibles d'utilisation. Ils servent de lumière agréable pour la lecture ou peuvent être positionnés afin d'offrir une lumière ciblée.

OVERVIEW

CLIP & PLUG LUMINAIRES



CABADO
p. 752



FABIO
p. 752



RICCIO 1
p. 753



TINEO
p. 753



MINI 4
p. 754-755



DAKAR 3
p. 754



This product is available in different colors and shapes./ Dieser Artikel ist in unterschiedlichen Farben und Formen verfügbar.
Cet article est disponible en différentes couleurs et formes.



97077

LED

97077 CABADO

clamp light; plastic, white
Klemmleuchte; Kunststoff, weiss
luminaire à pince; plastique, blanc

L 120, B 65, H 420



1,6W



150lm



Li-ion



500mAh



9 002759 970772



H 420

L 120



81262

81262 FABIO

clamp light; steel, plastic, white, silver
Klemmleuchte; Stahl, Kunststoff, weiss, silber
luminaire à pince; acier, plastique, blanc, argent

H 300



E14



1x 40W



81265 FABIO

clamp light; steel, plastic, silver
Klemmleuchte; Stahl, Kunststoff, silber
luminaire à pince; acier, plastique, argent

H 300



E14



1x 40W



9 002759 812621



H 300



9 002759 812652



H 300



94329

LED

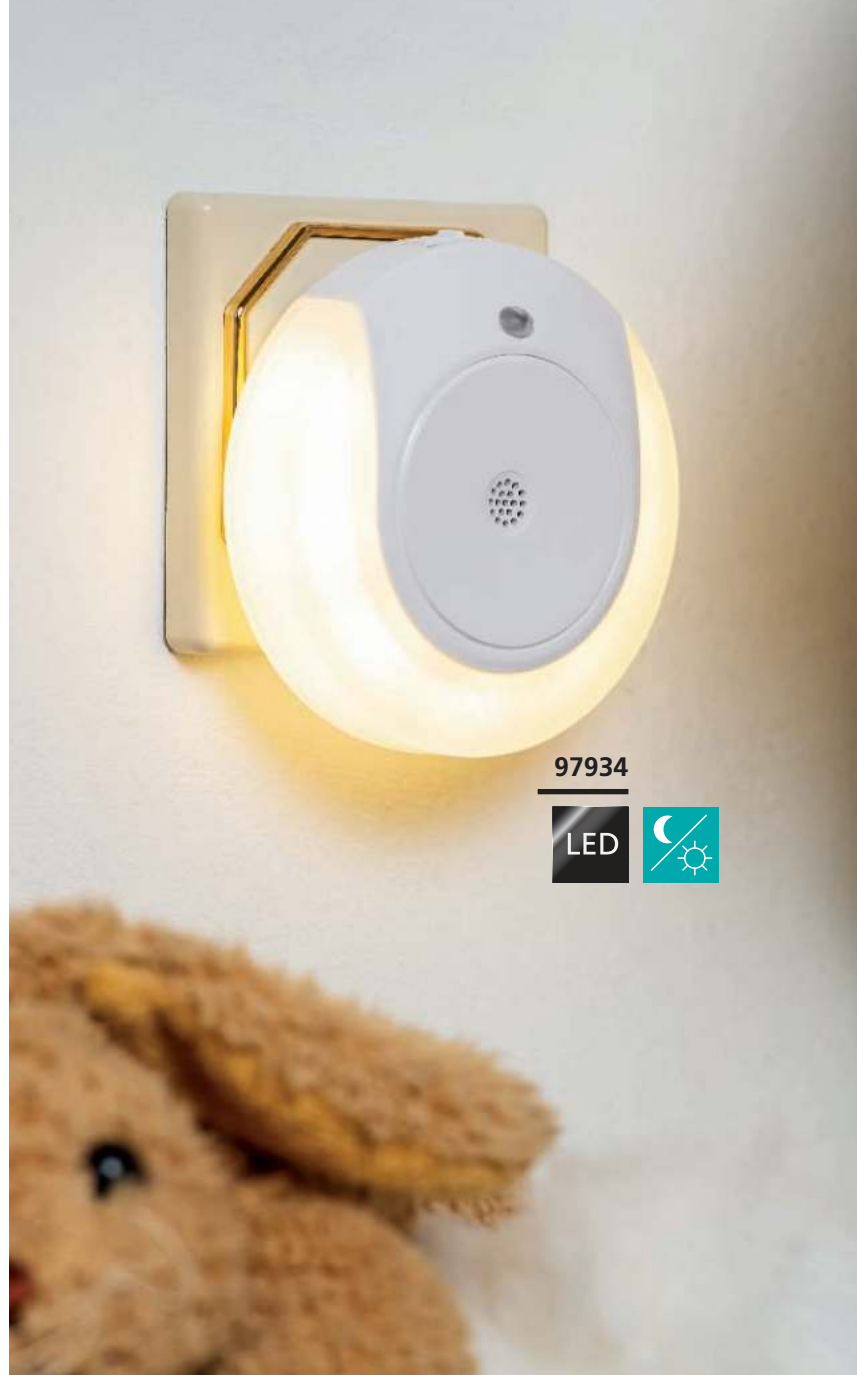

97934

LED

94329 RICCIO 1

clamp light; plastic, steel, white, chrome / steel, white, chrome
 Klemmleuchte; Kunststoff, Stahl, weiss, chrom / Stahl, weiss, chrom
 luminaire à pince; plastique, acier, blanc, chrome / acier, blanc, chrome

L 180, H 330



9 002759 943295

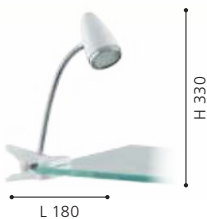

97934 TINEO

plug light; plastic, white
 Steckerleuchte; Kunststoff, weiss
 luminaire sur prise; plastique, blanc

L 90, B 70, H 90



9 002759 979348



97934

This luminaire is equipped with a voice sensor. If an acoustic signal reaches an intensity of 60 dB, the night light will switch on automatically.

Diese Leuchte ist mit einem Akustiksensoren ausgestattet. Bei einem akustischen Signal ab 60 dB schaltet sich das Nachtlicht automatisch ein.

Cette lumière est équipée d'un capteur acoustique. A un signal acoustique dès 60 dB, la lumière de nuit s'intervient automatiquement.



92924

LED



92925

LED



92935

92925 MINI 4

plug light; steel, white, chrome
Steckerleuchte; Stahl, weiss, chrom
luminaire sur prise; acier, blanc, chrome

L 70, H 100

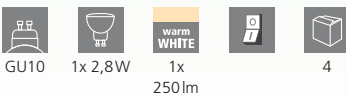

92924 MINI 4

plug light; steel, satin nickel, chrome
Steckerleuchte; Stahl, nickel-matt, chrom
luminaire sur prise; acier, nickel mat, chrome

L 70, H 100



92935 DAKAR 3

plug light; steel, satin nickel, chrome / plastic, white
Steckerleuchte; Stahl, nickel-matt, chrom / Kunststoff, weiss
luminaire sur prise; acier, nickel mat, chrome / plastique, blanc

L 70, H 180, A 280

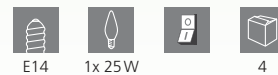



92933

LED

92933 MINI 4

plug light; steel, satin nickel, chrome
Steckerleuchte; Stahl, nickel-matt, chrom
luminaire sur prise; acier, nickel mat, chrome

L 70, H 180, A 220



GU10



1x 2,8W



1x
warm
WHITE
250lm



4



9 002759 929336



INCL.



TABLE & FLOOR LUMINAIRES

TISCH- & STEHLEUCHTEN

LUMINAIRES DE TABLE & LAMPADAIRES

WE LOVE LIGHT

The range of table and floor luminaires is made up of many different styles and convinces with its diverse uses. The luminaires give your home a comfortable light mood and turn into chic living room accessories.

WIR STEHEN AUF LICHT

Das Sortiment der Tisch- und Stehleuchten setzt sich aus unterschiedlichen Stilen zusammen und überzeugt mit seinen vielseitigen Einsatzmöglichkeiten. Die Leuchten verleihen Ihrem Zuhause eine gemütliche Lichtstimmung und werden zum schicken Wohnraumaccessoire.

























































NOUS NOUS TENONS EN PLEINE LUMIÈRE

La gamme de luminaires de table et lampadaires est formée de différents styles et persuade par ses multiples possibilités d'application. Les lampes donnent à votre intérieur une lumière conviviale et se transforment en des accessoires d'habitat chics.



OVERVIEW

TABLE & FLOOR LUMINAIRES

 FONDACHELLI p. 760	 NOSINO p. 761	 ESTAZIONA p. 761	 CONESA p. 762	 ESPARTAL p. 763	 NADINA p. 763	 REKALDE p. 764	 ONEDA p. 764
 CORTADERAS p. 765	 ARANZOLA p. 765	 BELESER p. 766	 BUDENSEA p. 766	 CARBONERAS p. 767	 PICACHA p. 767	 BARBOTTO p. 768	 DARNIUS p. 768
 BORGILLIO p. 769	 UP 2 p. 770-771	 BAYA LED p. 772-773	 SARRIONE p. 774	 BAYA p. 774	 VILLABATE 1 p. 776-777	 PASTERI p. 777	 CARLTON 2 p. 778
 PEDREGAL 1 p. 779	 CHIETINO 1 p. 780	 MANALBA 1 p. 781	 MANALBA p. 781	 BELLARIVA p. 782	 BELLARIVA 3 p. 783	 TRONDIO p. 783	 TAREGA p. 783
 CAHUAMA p. 784	 BATISTA 3 p. 785	 TURIALDO 1 p. 785	 SWARBY p. 785	 MURNIA p. 786	 PETTO 1 p. 787	 BATABANO p. 787	 ERMUA p. 787
 AMEZAGA p. 788	 MARYVILLA p. 788	 SARONA p. 788	 MANTUNALLE p. 790	 CASTELLATO p. 790	 BILBANA p. 790	 OLIVAL 1 p. 791	 SOLO 2 p. 791
 SOLO 1 p. 792	 SOLO p. 793	 DAMASCO 1 p. 793-794	 SLIM p. 793	 GEO p. 795	 NARANJO p. 797	 DESIERTO p. 797	



This product is available in different colors and shapes./ Dieser Artikel ist in unterschiedlichen Farben und Formen verfügbar.
Cet article est disponible en différentes couleurs et formes.





95539



95541



900187

95539 FONDACHELLI

floor light; steel, satin nickel / fabric, white, silver
 Stehleuchte; Stahl, nickel-matt / Textil, weiss, silber
 lampadaire; acier, nickel mat / tissu, blanc, argent

H 1515, Ø 510



E27 1x 60W



9 002759 955397

95541 FONDACHELLI

floor light; steel, black / fabric, black, copper
 Stehleuchte; Stahl, schwarz / Textil, schwarz, kupfer
 lampadaire; acier, noir / tissu, noir, cuivre

H 1515, Ø 510

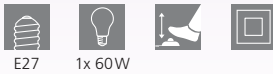

E27 1x 60W



9 002759 955410

900187 FONDACHELLI

floor light; steel, black / fabric, linen, grey
 Stehleuchte; Stahl, schwarz / Textil, Leinen, grau
 lampadaire; acier, noir / tissu, lin, gris

H 1515, Ø 510

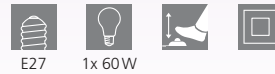

E27 1x 60W



9 008606 234479



99101



99015

99101 NOSINO

table light; steel, black / fabric, white
Tischleuchte; Stahl, schwarz / Textil, weiss
luminaire de table; acier, noir / tissu, blanc

H 580, Ø 220, Base: Ø 220

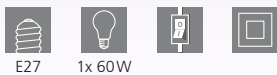

E27 1x 60W



9 002759 991012

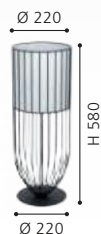

99015 ESTAZIONA

floor light; steel, black / fabric, black
Stehleuchte; Stahl, schwarz / Textil, schwarz
lampadaire; acier, noir / tissu, noir

L 260, B 235, H 1500, Base: Ø 245

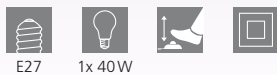

E27 1x 40W



9 002759 990152

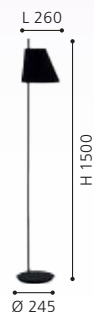



95686



98309

LED

95686 CONESA

floor light; steel, satin nickel / fabric, glass, white
 Stehleuchte; Stahl, nickel-matt / Textil, Glas, weiss
 lampadaire; acier, nickel mat / tissu, verre, blanc

H 1700, Ø 380, Base: Ø 230



E27



1x 60W



E14



1x 40W



9 002759 956868





92206

98309 ESPARTAL

floor light; steel, aluminium, satin nickel, aluminium / fabric, white

Stehleuchte; Stahl, Alu, nickel-matt, alu / Textil, weiss

lampadaire; acier, aluminium, nickel mat, aluminium / tissu, blanc

H 1485, Ø 250, Base: Ø 250



E27



1x 60W



11,8W



1650lm



9 002759 983093



92206 NADINA

floor light; steel, satin nickel / fabric with hoop-and-loop tape, white

Stehleuchte; Stahl, nickel-matt / Textil mit Klettverschluss, weiss

lampadaire; acier, nickel mat / tissu avec fermeture velcro, blanc

L 1790, B 380, H 1950, Base: Ø 320



E27



1x 60W



9 002759 922061





98674



900393



900394

98674 REKALDE

floor light; steel, black, white
Stehleuchte; Stahl, schwarz, weiss
lampadaire; acier, noir, blanc

L 290, B 160, H 1500, Base: Ø 250



E27 1x 40W



9 002759 986742



900393 ONEDA

table light; steel, black, white
Tischleuchte; Stahl, schwarz, weiss
luminaire de table; acier, noir, blanc

L 290, B 145, H 445, Base: Ø 210



E27 1x 40W



9 008606 243716



900394 ONEDA

floor light; steel, black, white
Stehleuchte; Stahl, schwarz, weiss
lampadaire; acier, noir, blanc

L 540, B 200, H 1605, Base: Ø 315



E27 1x 40W



9 008606 243723

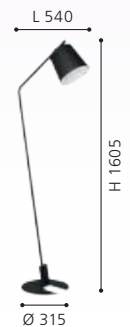



97806

LED



900134



900135

97806 CORTADERAS

floor light; steel, black, gold
Stehleuchte; Stahl, schwarz, gold
lampadaire; acier, noir, or

H 1445, Ø 250, Base: Ø 250

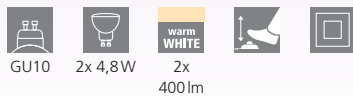

GU10 2x 4,8W 2x warm WHITE 400lm



9 002759 978068



900134 ARANZOLA

table light; steel, black, white
Tischleuchte; Stahl, schwarz, weiss
luminaire de table; acier, noir, blanc

H 450, Ø 300, Base: Ø 115

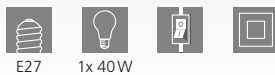

E27 1x 40W



9 008606 240012



900135 ARANZOLA

floor light; steel, black, white
Stehleuchte; Stahl, schwarz, weiss
lampadaire; acier, noir, blanc

L 300, H 1635, Base: Ø 300

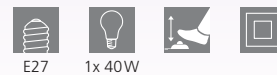

E27 1x 40W



9 008606 240029

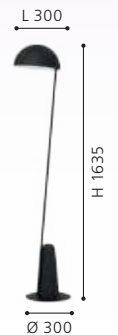



DESIGN
HIGHLIGHT
DETAIL



98386



98387



99113

LED

98386 BELESER

table light; steel, black / glass vaporized, black-transparent
Tischleuchte; Stahl, schwarz / Glas bedampft, schwarz-transparent
luminaire de table; acier, noir / verre vaporisé, noir transparent

L 265, B 205, H 505, Base: Ø 200



98387 BELESER

floor light; steel, black / glass vaporized, black-transparent
Stehleuchte; Stahl, schwarz / Glas bedampft, schwarz-transparent
lampadaire; acier, noir / verre vaporisé, noir transparent

L 260, B 205, H 1505, Base: Ø 220



99113 BUDENSEA

floor light; cast aluminium, black, white
Stehleuchte; Aluguss, schwarz, weiss
lampadaire; fonte d'aluminium, noir, blanc

L 365, B 250, H 1800, Base: B 300, T 250

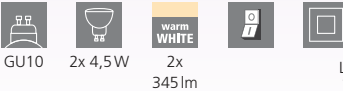



99822

LED



99882

The heads of this luminaire can be switched and dimmed separately.

Die Köpfe dieser Leuchte sind getrennt voneinander schaltbar und dimmbar.

Les têtes de ce luminaire peuvent être commutées et gradées séparément.



99113

This lamp is rotatable.

Diese Leuchte ist drehbar.

Cette lampe est rotative.

0-180°

0-80°

99822 CARBONERAS

floor light; steel, black / plastic, transparent
 Stehleuchte; Stahl, schwarz / Kunststoff, transparent
 lampadaire; acier, noir / plastique, transparent

L 400, B 250, H 1800, Base: B 330, T 240



6x 3,8W 2400lm 7W 750lm



9 002759 998226

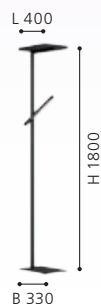

99715 PICACHA

floor light; steel, black / plastic, white
 Stehleuchte; Stahl, schwarz / Kunststoff, weiss
 lampadaire; acier, noir / plastique, blanc

H 1625, Base: B 150, T 150



29W 3500lm



9 002759 997151



99715

LED



97583

LED



97584

LED



98458

97583 BARBOTTO

table light; steel, black, gold
Tischleuchte; Stahl, schwarz, gold
luminaire de table; acier, noir, or

H 395, Ø 60, Base: Ø 100



GU10



1x 4,5W



warm WHITE

1x

345lm



9 002759 975838



97584 BARBOTTO

floor light; steel, black, gold
Stehleuchte; Stahl, schwarz, gold
lampadaire; acier, noir, or

H 1370, Ø 60, Base: Ø 185



GU10



1x 4,5W



warm WHITE

1x

345lm



9 002759 975845



98458 DARNIUS

floor light; steel, black, gold
Stehleuchte; Stahl, schwarz, gold
lampadaire; acier, noir, or

H 1420, Ø 380, Base: Ø 645



E27



1x 40W



9 002759 984588



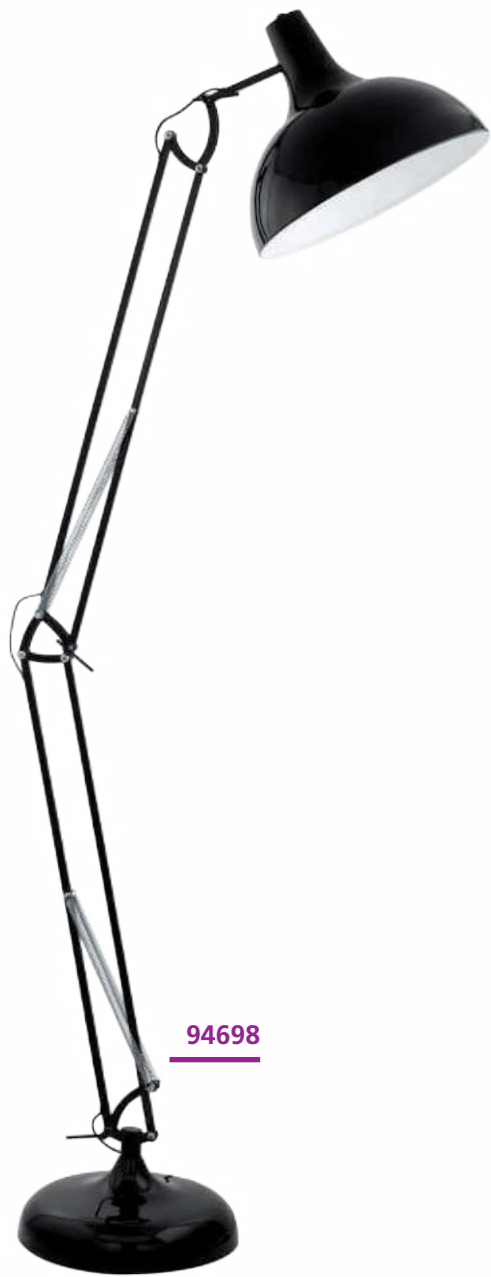

94698



94705

94698 BORGILLIO

floor light; steel, black
Stehleuchte; Stahl, schwarz
lampadaire; acier, noir

L 380, H 1900, Base: Ø 340



E27 1x 60W

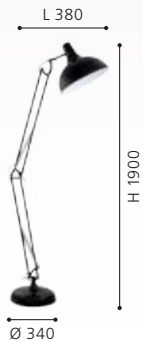

9 002759 946982

94705 BORGILLIO

floor light; steel, copper
Stehleuchte; Stahl, kupfer
lampadaire; acier, cuivre

L 380, H 1900, Base: Ø 340



E27 1x 60W

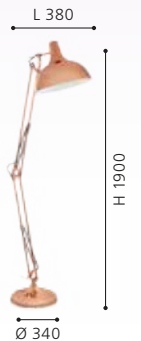

9 002759 947057



93917



82842



82843

93917 UP 2

floor light; steel, nickel-nero / plastic, glass, white
 Stehleuchte; Stahl, nickel-nero / Kunststoff, Glas, weiss
 lampadaire; acier, nickel noir / plastique, verre, blanc

H 1765, Ø 275, Base: Ø 230

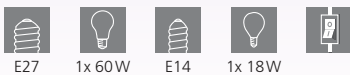

82842 UP 2

floor light; steel, satin nickel / plastic, glass, white
 Stehleuchte; Stahl, nickel-matt / Kunststoff, Glas, weiss
 lampadaire; acier, nickel mat / plastique, verre, blanc

H 1765, Ø 275, Base: Ø 230



82843 UP 2

floor light; steel, brass-matt / plastic, glass, white
 Stehleuchte; Stahl, messing-matt / Kunststoff, Glas, weiss
 lampadaire; acier, laiton mat / plastique, verre, blanc

H 1765, Ø 275, Base: Ø 230

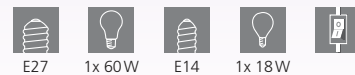



82844

DESIGN
HIGHLIGHT
DETAIL



82844 UP 2

floor light; steel, bronzed / plastic, glass, white
Stehleuchte; Stahl, brüniert / Kunststoff, Glas, weiss
lampadaire; acier, brun / plastique, verre, blanc

H 1765, Ø 275, Base: Ø 230



E27



1x 60W



E14



1x 18W



9 002759 828448





93877



93876



93875



93877 BAYA LED

floor light; steel, brass / glass, plastic, white, satiné
 Stehleuchte; Stahl, messing / Glas, Kunststoff, weiss, satiniert
 lampadaire; acier, laiton / verre, plastique, blanc, satiné

L 360, H 1800, Base: Ø 250

LED 20W warm WHITE 1950lm LED 2,5W warm WHITE 240lm LED 2,5W

warm WHITE 250lm



9 002759 938772



93876 BAYA LED

floor light; steel, bronzed / glass, plastic, white, satiné
 Stehleuchte; Stahl, brüniert / Glas, Kunststoff, weiss, satiniert
 lampadaire; acier, brun / verre, plastique, blanc, satiné

L 360, H 1800, Base: Ø 250

LED 20W warm WHITE 1950lm LED 2,5W warm WHITE 240lm LED 2,5W

warm WHITE 250lm



9 002759 938765



93875 BAYA LED

floor light; steel, chrome / glass, plastic, white, satiné
 Stehleuchte; Stahl, chrom / Glas, Kunststoff, weiss, satiniert
 lampadaire; acier, chrome / verre, plastique, blanc, satiné

L 360, H 1800, Base: Ø 250

LED 20W warm WHITE 1950lm LED 2,5W warm WHITE 240lm LED 2,5W

warm WHITE 250lm



9 002759 938758





DESIGN
HIGHLIGHT
DETAIL



93874

LED

93874 BAYA LED

floor light; steel, satin nickel / glass, plastic, white, satined
Stehleuchte; Stahl, nickel-matt / Glas, Kunststoff, weiss, satiniert
lampadaire; acier, nickel mat / verre, plastique, blanc, satiné

L 360, H 1800, Base: Ø 250

- LED
20W
- warm
WHITE
2200lm
- LED
2,5W
- warm
WHITE
250lm
- LED
2,5W

- warm
WHITE
250lm
-
-
-
-

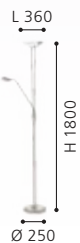



DESIGN
HIGHLIGHT
DETAIL



93713
LED



85974

93713 SARRIONE

floor light; steel, satin nickel / plastic, satined
Stehleuchte; Stahl, nickel-matt / Kunststoff, satiniert
lampadaire; acier, nickel mat / plastique, satiné

H 1800, Base: Ø 250

LED 17W warm WHITE 1900lm LED 3W warm WHITE 340lm LED 4,5W

warm WHITE 500lm



9 002759 937133

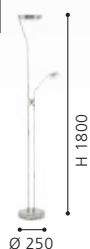

85974 BAYA

floor light; steel, bronzed / satin glass, white
Stehleuchte; Stahl, brüniert / Glas satiniert, weiss
lampadaire; acier, brun / verre satiné, blanc

L 440, H 1800, Base: Ø 280

R7S 1x 230W G9 1x 33W



9 002759 859749



85971 BAYA

floor light; steel, satin nickel / satin glass, white
Stehleuchte; Stahl, nickel-matt / Glas satiniert, weiss
lampadaire; acier, nickel mat / verre satiné, blanc

L 440, H 1800, Base: Ø 280

R7S 1x 230W G9 1x 33W



9 002759 859718

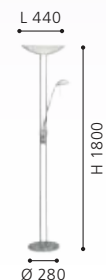



85971



99103

99103 VILLABATE 1

table light; steel, black / fabric, black, white
Tischleuchte; Stahl, schwarz / Textil, schwarz, weiss
luminaire de table; acier, noir / tissu, noir, blanc

L 185, B 160, H 175



E27



1x 25W





99104



95726



95725

99104 VILLABATE 1

table light; steel, satin nickel / fabric, taupe, white
Tischleuchte; Stahl, nickel-matt / Textil, taupe, weiss
luminaire de table; acier, nickel mat / tissu, taupe, blanc

L 185, B 160, H 175



E27 1x 25W



9 002759 991043



95726 PASTERI

table light; steel, satin nickel / fabric, taupe
Tischleuchte; Stahl, nickel-matt / Textil, taupe
luminaire de table; acier, nickel mat / tissu, taupe

H 275, Ø 140, Base: Ø 120

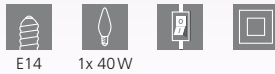

E14 1x 40W



9 002759 957261



95725 PASTERI

table light; steel, satin nickel / fabric, white
Tischleuchte; Stahl, nickel-matt / Textil, weiss
luminaire de table; acier, nickel mat / tissu, blanc

H 275, Ø 140, Base: Ø 120

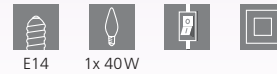

E14 1x 40W



9 002759 957254



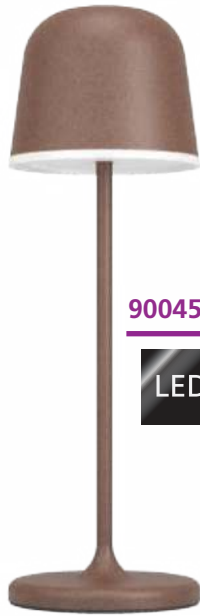

900459

LED

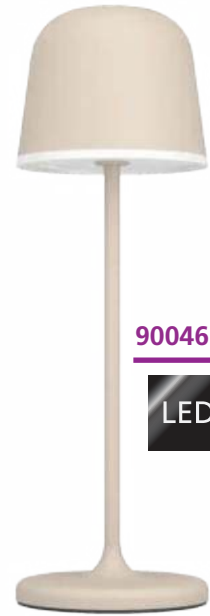

900461

LED

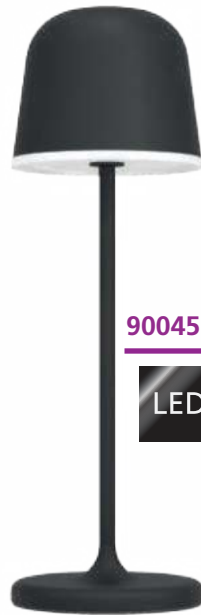

900457

LED

900459 MANNERA

table light; aluminium, steel, auburn / plastic, white
Tischleuchte; Alu, Stahl, rostbraun / Kunststoff, weiss
luminaire de table; aluminium, acier, brun rouille / plastique, blanc

H 340, Ø 110, Base: Ø 110

LED 2,2W warm WHITE 200lm ACCU Li-ion 1800mAh

IP54



9 008606 244003

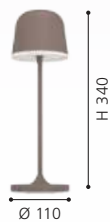

900457 MANNERA

table light; aluminium, steel, black / plastic, white
Tischleuchte; Alu, Stahl, schwarz / Kunststoff, weiss
luminaire de table; aluminium, acier, noir / plastique, blanc

H 340, Ø 110, Base: Ø 110

LED 2,2W warm WHITE 200lm ACCU Li-ion 1800mAh

IP54



9 008606 243990



900461 MANNERA

table light; aluminium, steel, sandy / plastic, white
Tischleuchte; Alu, Stahl, sandfarben / Kunststoff, weiss
luminaire de table; aluminium, acier, couleur sable / plastique, blanc

H 340, Ø 110, Base: Ø 110

LED 2,2W warm WHITE 200lm ACCU Li-ion 1800mAh

IP54



9 008606 243983





900458

LED

900458 MANNERA

table light; aluminium, steel, grey / plastic, white

Tischleuchte; Alu, Stahl, grau / Kunststoff, weiss

luminaire de table; aluminium, acier, gris / plastique, blanc

H 340, Ø 110, Base: Ø 110



2,2W



200lm



Li-ion



1800 mAh



IP54



9 008606 243976



H 340

Ø 110



95789



95787



95788

95789 CARLTON 2

table light; steel, black / fabric, white
Tischleuchte; Stahl, schwarz / Textil, weiss
luminaire de table; acier, noir / tissu, blanc

H 305, Ø 165, Base: Ø 95

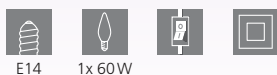

E14 1x 60W



9 002759 957896



95787 CARLTON 2

table light; steel, copper / fabric, black, copper
Tischleuchte; Stahl, kupfer / Textil, schwarz, kupfer
luminaire de table; acier, cuivre / tissu, noir, cuivre

H 305, Ø 165, Base: Ø 95



E14 1x 60W



9 002759 957872



95788 CARLTON 2

table light; steel, brass / fabric, black, gold
Tischleuchte; Stahl, messing / Textil, schwarz, gold
luminaire de table; acier, laiton / tissu, noir, or

H 305, Ø 165, Base: Ø 95



E14 1x 60W



9 002759 957889





95185

95185 PEDREGAL 1

table light; steel, copper / fabric, black, copper
 Tischleuchte; Stahl, kupfer / Textil, schwarz, kupfer
 luminaire de table; acier, cuivre / tissu, noir, cuivre

H 645, Ø 350, Base: Ø 300



E27



1x 60W



9 002759 951856





97516

97516 CHIETINO 1

table light; wood, steel, natural, chrome / fabric, white
Tischleuchte; Holz, Stahl, natur, chrom / Textil, weiss
luminaire de table; bois, acier, naturel, chrome / tissu, blanc

H 440, Ø 260, Base: B 235, T 235



E27



1x 60W





99329



99331



95386

99329 MANALBA 1

table light; ceramic, silver / fabric, white, silver
Tischleuchte; Keramik, silber / Textil, weiss, silber
luminaire de table; céramique, argent / tissu, blanc, argent

H 300, Ø 200, Base: Ø 125



E14 1x 40W



9 002759 993290



99331 MANALBA 1

table light; ceramic, gold-coloured / fabric, black, gold
Tischleuchte; Keramik, goldfarben / Textil, schwarz, gold
luminaire de table; céramique, or / tissu, noir, or

H 300, Ø 200, Base: Ø 125



E14 1x 40W



9 002759 993313



95386 MANALBA

table light; steel, gold / fabric, black, gold
Tischleuchte; Stahl, gold / Textil, schwarz, gold
luminaire de table; acier, or / tissu, noir, or

H 380, Ø 250, Base: Ø 160

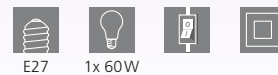

E27 1x 60W



9 002759 953867





97774



97773



97774 BELLARIVA

table light; ceramic, grey / fabric, white
Tischleuchte; Keramik, grau / Textil, weiss
luminaire de table; céramique, gris / tissu, blanc

H 320, Ø 150, Base: Ø 120



E14 1x 40W



97773 BELLARIVA

table light; ceramic, creme-white / fabric, white
Tischleuchte; Keramik, creme-weiss / Textil, weiss
luminaire de table; céramique, blanc crème / tissu, blanc

H 320, Ø 150, Base: Ø 120



E14 1x 40W





99332



93046



95527

99332 BELLARIVA 3

table light; ceramic, white / fabric, linen, light brown
Tischleuchte; Keramik, weiss / Textil, Leinen, hellbraun
luminaire de table; céramique, blanc / tissu, lin, marron transparent

H 360, Ø 200, Base: Ø 160



E27 1x 40W



9 002759 993320



93046 TRONDIO

table light; ceramic, white / fabric, white
Tischleuchte; Keramik, weiss / Textil, weiss
luminaire de table; céramique, blanc / tissu, blanc

H 270, Ø 150, Base: Ø 120



E14 1x 40W



9 002759 930462



95527 TAREGA

table light; wood, concrete, brown, grey / fabric, brown
Tischleuchte; Holz, Beton, braun, grau / Textil, braun
luminaire de table; bois, béton, marron, gris / tissu, marron

H 370, Ø 250, Base: Ø 150

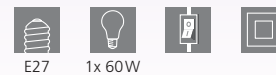

E27 1x 60W



9 002759 955274





99824



99825

99824 CAHUAMA

table light; ceramic, light brown / glass, white
Tischleuchte; Keramik, hellbraun / Glas, weiss
luminaire de table; céramique, marron clair / verre, blanc

H 300, Ø 275, Base: Ø 105



E27 1x 40W



99825 CAHUAMA

table light; ceramic, white, black / glass, grey matt
Tischleuchte; Keramik, weiss, schwarz / Glas, grau matt
luminaire de table; céramique, blanc, noir / verre, gris mat

H 300, Ø 275, Base: Ø 105



E27 1x 40W





97589



97589



900334



98859

97589 BATISTA 3

table light; steel, satin nickel / glass wiping technique, white
Tischleuchte; Stahl, nickel-matt / Glas Wischtechnik, weiss
luminaire de table; acier, nickel mat / technique de verre essuyé, blanc

H 225, Ø 120, Base: Ø 110



E27 1x 40W



9 002759 975890



900334 TURIALDO 1

table light; wood, steel, black
Tischleuchte; Holz, Stahl, schwarz
luminaire de table; bois, acier, noir

H 100, Ø 85



E27 1x 28W



9 008606 235636



98859 SWARBY

table light; cement, grey
Tischleuchte; Zement, grau
luminaire de table; ciment, gris

H 120, Ø 100



E27 1x 60W



9 002759 988593





900314



DESIGN
HIGHLIGHT
DETAIL



900314 MURNIA

table light; steel, black, white
Tischleuchte; Stahl, schwarz, weiss
luminaire de table; acier, noir, blanc

L 190, B 165, H 430, Base: Ø 165



E14



1x 40W



9 008606 235421





94513

LED



900396



98837

LED



DESIGN
HIGHLIGHT
DETAIL

94513 PETTO 1

table light; steel, white
Tischleuchte; Stahl, weiss
luminaire de table; acier, blanc

H 135, Ø 105, Base: Ø 90



900396 BATABANO

table light; steel, sandy, black
Tischleuchte; Stahl, sandfarben, schwarz
luminaire de table; acier, couleur sable, noir

H 275, Ø 180, Base: Ø 160

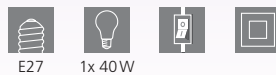

98837 ERMUA

table light; steel, wood, black, brown / plastic, white
Tischleuchte; Stahl, Holz, schwarz, braun / Kunststoff, weiss
luminaire de table; acier, bois, noir, marron / plastique, blanc

L 330, B 165, H 505, Base: B 240, T 160





98864



900552

98864 AMEZAGA

table light; steel, black, brass
Tischleuchte; Stahl, schwarz, messing
luminaire de table; acier, noir, laiton

L 355, B 160, H 575, Base: Ø 170



E27 1x 10W



9 002759 988647

900552 MARYVILLA

table light; steel, bronzed / glass vaporized, clear, gold
Tischleuchte; Stahl, brüniert / Glas bedampft, klar, gold
luminaire de table; acier, brun / verre vaporisé, transparent, or

H 230, Ø 170, Base: Ø 130



E27 1x 40W



9 008606 244577

900403 SARONA

table light; steel, black, gold
Tischleuchte; Stahl, schwarz, gold
luminaire de table; acier, noir, or

H 315, Ø 140, Base: B 140



GU10 1x 4,5W 1x 345lm



9 008606 243785





900403





99369



97333 | 900358



99369



97333



900358

99369 MANTUNALLE

table light; steel, black / glass, white
Tischleuchte; Stahl, schwarz / Glas, weiss
luminaire de table; acier, noir / verre, blanc

H 400, Ø 200, Base: Ø 220



E27 1x 40W



9 002759 993696

97333 CASTELLATO

table light; steel, black / glass opal-matt, white
Tischleuchte; Stahl, schwarz / Glas opal-matt, weiss
luminaire de table; acier, noir / verre opale mat, blanc

H 330, Ø 210



E14 1x 28W

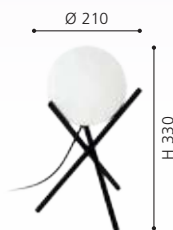

9 002759 973339

900358 BILBANA

table light; steel, black / glass opal-matt, white
Tischleuchte; Stahl, schwarz / Glas opal-matt, weiss
luminaire de table; acier, noir / verre opale mat, blanc

L 145, B 135, H 195, Base: B 135, T 115



E14 1x 40W



9 008606 241071



97209 OLIVAL 1

table light; steel, black / smoked glass, black-transparent
Tischleuchte; Stahl, schwarz / Rauchglas, schwarz-transparent
luminaire de table; acier, noir / verre fumé, noir transparent

L 200, B 200, H 305



900141 SOLO 2

table light; steel, black / glass vaporized, black-transparent
Tischleuchte; Stahl, schwarz / Glas bedampft, schwarz-transparent
luminaire de table; acier, noir / verre vaporisé, noir transparent

H 415, Ø 260, Base: Ø 180



900142 SOLO 2

table light; steel, black / glass etched, white
Tischleuchte; Stahl, schwarz / Glas geätzt, weiss
luminaire de table; acier, noir / verre gravé, blanc

H 415, Ø 260, Base: Ø 180

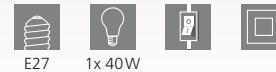



87254



87256



85104

87254 SOLO 1

table light; steel, brass-matt / satin glass, white
Tischleuchte; Stahl, messing-matt / Glas satiniert, weiss
luminaire de table; acier, laiton mat / verre satiné, blanc

H 350, Ø 260, Base: Ø 130



E14 1x 40W



9 002759 872540



87256 SOLO 1

table light; steel, wood, bronzed, nut / satin glass, white
Tischleuchte; Stahl, Holz, brüniert, Nuss / Glas satiniert, weiss
luminaire de table; acier, bois, brun, noisette / verre satiné, blanc

H 350, Ø 260, Base: Ø 130

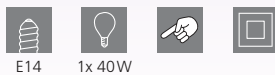

E14 1x 40W



9 002759 872564



85104 SOLO 1

table light; steel, satin nickel / satin glass, white
Tischleuchte; Stahl, nickel-matt / Glas satiniert, weiss
luminaire de table; acier, nickel mat / verre satiné, blanc

H 350, Ø 260, Base: Ø 130

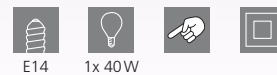

E14 1x 40W



9 002759 851040





91238



95785



95785



82305



82305

91238 SOLO

table light; steel, satin nickel / satin glass, white with decor
Tischleuchte; Stahl, nickel-matt / Glas satiniert, weiss m. Dekor
luminaire de table; acier, nickel mat / verre satiné, blanc avec décor

H 320, Ø 265, Base: Ø 130

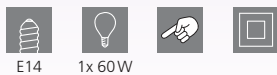

E14 1x 60W



9 002759 912383



95785 DAMASCO 1

table light; steel, satin nickel / glass opal-matt, white
Tischleuchte; Stahl, nickel-matt / Glas opal-matt, weiss
luminaire de table; acier, nickel mat / verre opale mat, blanc

H 300, Ø 145, Base: Ø 120



E14 1x 60W



9 002759 957858



82305 SLIM

table light; steel, satin nickel / glass, white
Tischleuchte; Stahl, nickel-matt / Glas, weiss
luminaire de table; acier, nickel mat / verre, blanc

H 220, Ø 70, Base: Ø 100

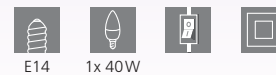

E14 1x 40W



9 002759 823054

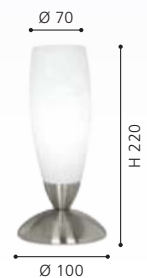



95775 | 95776 | 81828



95775



95776



98887

95775 DAMASCO 1

table light; steel, satin nickel / satin glass, white
Tischleuchte; Stahl, nickel-matt / Glas satiniert, weiss
luminaire de table; acier, nickel mat / verre satiné, blanc

H 215, Ø 100

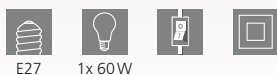

E27 1x 60W



9 002759 957759



95776 DAMASCO 1

table light; steel, chrome / satin glass, white
Tischleuchte; Stahl, chrom / Glas satiniert, weiss
luminaire de table; acier, chrome / verre satiné, blanc

H 215, Ø 100



E27 1x 60W



9 002759 957766



98887 DAMASCO 1

table light; steel, black / glass vaporized, black-transparent
Tischleuchte; Stahl, schwarz / Glas bedampft, schwarz-transparent
luminaire de table; acier, noir / verre vaporisé, noir transparent

H 310, Ø 100



E27 1x 60W



9 002759 988876





81827 | 91242



81827



81828



91242

81827 GEO

table light; glass, plastic, white
Tischleuchte; Glas, Kunststoff, weiss
luminaire de table; verre, plastique, blanc

H 200, Ø 100, Base: Ø 100

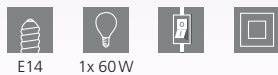

E14 1x 60W



9 002759 818272



81828 GEO

table light; glass opal-matt, white
Tischleuchte; Glas opal-matt, weiss
luminaire de table; verre opale mat, blanc

H 350, Ø 120, Base: Ø 120

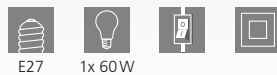

E27 1x 60W



9 002759 818289



91242 GEO

table light; glass, plastic, white
Tischleuchte; Glas, Kunststoff, weiss
luminaire de table; verre, plastique, blanc

H 200, Ø 100

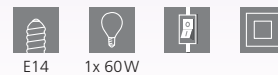

E14 1x 60W



9 002759 912420





99597

LED

DESIGN
HIGHLIGHT
DETAIL



99794



99597 NARANJO

table light; steel, black / glass, clear
Tischleuchte; Stahl, schwarz / Glas, klar
luminaire de table; acier, noir / verre, transparent

L 450, B 430, H 555



4x 4,1 W 1520lm



99794 DESIERTO

table light; steel, wood, black, brown
Tischleuchte; Stahl, Holz, schwarz, braun
luminaire de table; acier, bois, noir, marron

H 540, Ø 450, Base: Ø 330

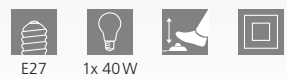

E27 1x 40W



OFFICE TABLE & FLOOR LUMINAIRES

BÜRO TISCH- & STEHLEUCHTEN

LUMINAIRES DE TABLE & LAMPADAIRES À BUREAU

WE LOVE LIGHT

The range of office table and floor luminaires is made up of many different styles and convinces with its diverse uses.

WIR STEHEN AUF LICHT

Das Sortiment der Büro Tisch- und Stehleuchten setzt sich aus unterschiedlichen Stilen zusammen und überzeugt mit seinen vielseitigen Einsatzmöglichkeiten.



NOUS NOUS TENONS EN PLEINE LUMIÈRE

La gamme d'éclairages de table et sur pieds à bureau est formée de différents styles et persuade par ses multiples possibilités d'application.



OVERVIEW

OFFICE TABLE & FLOOR LUMINAIRES

							
TRUNCA p. 802	MASSERIE p. 802	ARENAZA p. 803	BANDERALO p. 804	CASIBARE-QI p. 805	LACEY-QI p. 805	VERADAL-QI p. 805	SELLANO p. 806
							
LA SECA p. 807	CAUPO p. 808	BROLINI p. 809	COGNOLI p. 810	LAROIA p. 812-813	CEPPINO p. 814	VERADAL p. 814-815	DURENGO p. 816
							
DAMBERA p. 816	SNAPORA p. 816	GEXO p. 818	CABALES p. 818-819	CABADO 1 p. 820	CAJERO p. 820-821	TABILLANO 1 p. 822	TORONA 1 p. 822
							
BORGILLIO p. 824-825	BANKER p. 826	FIRMO p. 827	BASIC 1 p. 828	BASIC p. 828-829	FOX p. 830		



This product is available in different colors and shapes./ Dieser Artikel ist in unterschiedlichen Farben und Formen verfügbar.
Cet article est disponible en différentes couleurs et formes.



98093, 98247, 99828, 99829

These luminaires have a Qi charging function. They can wirelessly charge Qi-compatible Smartphones by inductive energy transfer.

Diese Leuchten besitzen eine Qi-Ladefunktion. Damit können Qi-kompatible Smartphones über induktive Energieübertragung kabellos geladen werden.

Ces luminaires disposent d'une fonction de chargement Qi. Cela permet aux smartphones compatibles Qi d'être chargés sans fil par transmission d'énergie inductive.



98093



98247



98093 TRUNCA

table light; plastic, white

Tischleuchte; Kunststoff, weiss

luminaire de table; plastique, blanc

H 485, Base: B 185, T 185



4W



450lm



9 002759 980931



98247 MASSERIE

table light; plastic, white

Tischleuchte; Kunststoff, weiss

luminaire de table; plastique, blanc

H 385, Base: B 165, T 165



3,4W



460lm



9 002759 982478





99828

LED



99829

LED



99828 ARENAZA

table light; steel, plastic, white, black
Tischleuchte; Stahl, Kunststoff, weiss, schwarz
luminaire de table; acier, plastique, blanc, noir

L 240, B 130, H 320, Base: B 240, T 120

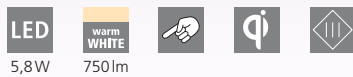

99829 ARENAZA

table light; steel, plastic, black
Tischleuchte; Stahl, Kunststoff, schwarz
luminaire de table; acier, plastique, noir

L 240, B 130, H 320, Base: B 240, T 120

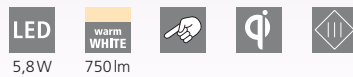



99831

LED

Qi Fast
Charger



99832

LED

Qi Fast
Charger



99831 BANDERALO

table light; plastic, white
Tischleuchte; Kunststoff, weiss
luminaire de table; plastique, blanc

L 305, B 170, H 405, Base: Ø 170

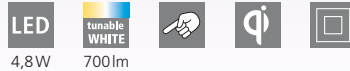

99832 BANDERALO

table light; plastic, black
Tischleuchte; Kunststoff, schwarz
luminaire de table; plastique, noir

L 305, B 170, H 405, Base: Ø 170

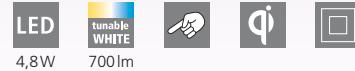



900626



900628



900626 LACEY-QI

table light; steel, wood, black, brown / steel, black, creme
 Tischleuchte; Stahl, Holz, schwarz, braun / Stahl, schwarz, creme
 luminaire de table; acier, bois, noir, marron / acier, noir, crème

L 255, B 135, H 485, Base: B 190, T 130

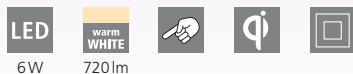

900628 VERADAL-QI

table light; wood, plastic, black, brown / steel, black
 Tischleuchte; Holz, Kunststoff, schwarz, braun / Stahl, schwarz
 luminaire de table; bois, plastique, noir, marron / acier, noir

B 125, H 490, Base: Ø 160

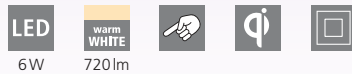



93901



93901

The touch buttons can be used to dim the luminaire and adjust the light colour.

Über die Berührungsschalter kann man die Leuchte dimmen und die Lichtfarbe einstellen.

Les boutons tactiles peuvent être utilisés pour dimmer et régler la couleur de la lumière.



93901 SELLANO

table light; plastic, steel, white, black
 Tischleuchte; Kunststoff, Stahl, weiss, schwarz
 luminaire de table; plastique, acier, blanc, noir

H 430, Base: B 180, T 180



4W



450lm



9 002759 939014





LA SECA

These luminaires have a USB port for charging and operating the luminaires.

Diese Leuchten verfügen über einen USB-Anschluss, der zum Laden und Betrieb der Leuchten dient.

Faites fonctionner et charger ces luminaires grâce au port USB.

97044 LA SECA

table light; plastic, white
Tischleuchte; Kunststoff, weiss
luminaire de table; plastique, blanc

L 200, B 50, H 260, Base: B 70, T 50

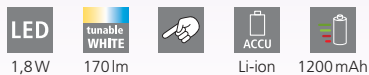

97045 LA SECA

table light; plastic, black
Tischleuchte; Kunststoff, schwarz
luminaire de table; plastique, noir

L 200, B 50, H 260, Base: B 70, T 50

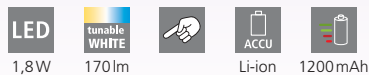

DESIGN
HIGHLIGHT
DETAIL



93966

LED



93965

LED

93966 CAUPO

table light; plastic, steel, black
Tischleuchte; Kunststoff, Stahl, schwarz
luminaire de table; plastique, acier, noir

L 260, H 320, Base: B 150, T 150

LED 2,1W tunable WHITE 210lm



9 002759 939663



93965 CAUPO

table light; plastic, steel, white
Tischleuchte; Kunststoff, Stahl, weiss
luminaire de table; plastique, acier, blanc

L 260, H 320, Base: B 150, T 150

LED 2,1W tunable WHITE 210lm



9 002759 939656





900529

LED



900528

LED

900529 BROLINI

table light; plastic, white
Tischleuchte; Kunststoff, weiss
luminaire de table; plastique, blanc

H 550, Ø 150, Base: Ø 150

LED 2,1W
 tunable WHITE 300lm
 touch control
 ACCU
 Li-ion 1500mAh



9 008606 242832



900528 BROLINI

table light; plastic, black
Tischleuchte; Kunststoff, schwarz
luminaire de table; plastique, noir

H 550, Ø 150, Base: Ø 150

LED 2,1W
 tunable WHITE 300lm
 touch control
 ACCU
 Li-ion 1500mAh



9 008606 242825





DESIGN
HIGHLIGHT
DETAIL



97915

LED

97915 COGNOLI

table light; plastic, white
Tischleuchte; Kunststoff, weiss
luminaire de table; plastique, blanc

L 70, B 100, H 510, Base: B 100, T 70

LED

neutral
WHITE



4,4W

430lm

L 70



9 002759 979157

97914 COGNOLI

table light; plastic, black
Tischleuchte; Kunststoff, schwarz
luminaire de table; plastique, noir

L 70, B 100, H 510, Base: B 100, T 70

LED

neutral
WHITE



4,4W

430lm

L 70



9 002759 979140



97914

LED



96437

LED



96434

LED



96438

LED

96437 LAROA

clamp light; plastic, black
Klemmleuchte; Kunststoff, schwarz
luminaire à pince; plastique, noir

L 450, B 65, H 275

LED

neutral
WHITE



3,5W

400lm



9 002759 964375



96434 LAROA

clamp light; plastic, white
Klemmleuchte; Kunststoff, weiss
luminaire à pince; plastique, blanc

L 450, B 65, H 275

LED

neutral
WHITE



3,5W

400lm



9 002759 964344

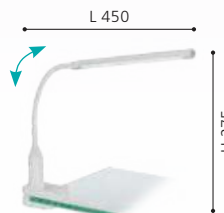

96438 LAROA

table light; plastic, black
Tischleuchte; Kunststoff, schwarz
luminaire de table; plastique, noir

L 480, B 120, H 325, Base: B 170, T 120

LED

neutral
WHITE



3,5W

400lm



9 002759 964382





96435

LED



96439

LED



96436

LED

96435 LAROA

table light; plastic, white
Tischleuchte; Kunststoff, weiss
luminaire de table; plastique, blanc

L 480, B 120, H 325, Base: B 170, T 120



3,5W 400lm



9 002759 964351



96439 LAROA

floor light; plastic, black
Stehleuchte; Kunststoff, schwarz
lampadaire; plastique, noir

L 535, B 215, H 1300, Base: Ø 210



3,5W 400lm



9 002759 964399



96436 LAROA

floor light; plastic, white
Stehleuchte; Kunststoff, weiss
lampadaire; plastique, blanc

L 535, B 215, H 1300, Base: Ø 210



3,5W 400lm



9 002759 964368

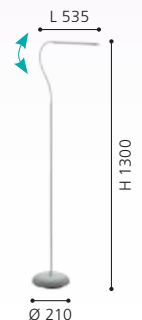

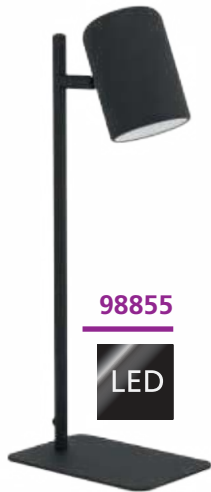

98855

LED



98856

LED



98832



98855 CEPPINO

table light; steel, black, white
Tischleuchte; Stahl, schwarz, weiss
luminaire de table; acier, noir, blanc

H 380, Base: B 165, T 110



GU10 1x 4,5W 1x warm WHITE 345lm



98856 CEPPINO

table light; steel, white
Tischleuchte; Stahl, weiss
luminaire de table; acier, blanc

H 380, Base: B 165, T 110

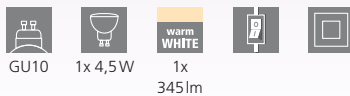

GU10 1x 4,5W 1x warm WHITE 345lm



98832 VERADAL

table light; wood, plastic, white, brown / steel, white
Tischleuchte; Holz, Kunststoff, weiss, braun / Stahl, weiss
luminaire de table; bois, plastique, blanc, marron / acier, blanc

B 125, H 490, Base: Ø 160



E27 1x 40W





98831



98831 VERADAL

table light; wood, plastic, black, brown / steel, black
Tischleuchte; Holz, Kunststoff, schwarz, braun / Stahl, schwarz
luminaire de table; bois, plastique, noir, marron / acier, noir

B 125, H 490, Base: Ø 160



E27



1x 40W



9 002759 988319





93078

LED



94673

LED

93078 DURENGO

table light; plastic, steel, white, chrome
Tischleuchte; Kunststoff, Stahl, weiss, chrom
luminaire de table; plastique, acier, blanc, chrome

H 380, Ø 160, Base: Ø 160

LED

warm
WHITE



2,5W

250lm

94673 DAMBERA

table light; plastic, black
Tischleuchte; Kunststoff, schwarz
luminaire de table; plastique, noir

H 375, Base: Ø 170

LED

warm
WHITE



4,5W

660lm

94677 SNAPORA

table light; plastic, aluminium, black
Tischleuchte; Kunststoff, Alu, schwarz
luminaire de table; plastique, aluminium, noir

H 485, Base: Ø 110

LED

warm
WHITE



3W

300lm



9 002759 930783



9 002759 946739



9 002759 946777





94677

LED



93076

LED



93077

LED



99334

LED

93076 GEXO

table light; plastic, steel, black, chrome
Tischleuchte; Kunststoff, Stahl, schwarz, chrom
luminaire de table; plastique, acier, noir, chrome

H 320, Ø 125, Base: Ø 125

LED

warm WHITE

230lm



9 002759 930769

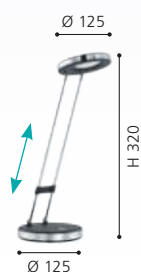

93077 GEXO

table light; plastic, steel, white, chrome
Tischleuchte; Kunststoff, Stahl, weiss, chrom
luminaire de table; plastique, acier, blanc, chrome

H 320, Ø 125, Base: Ø 125

LED

warm WHITE

230lm



9 002759 930776



99334 CABLES

table light; plastic, white
Tischleuchte; Kunststoff, weiss
luminaire de table; plastique, blanc

H 340, Ø 140, Base: Ø 140

LED

warm WHITE

490lm



9 002759 993344





99335

LED

99335 CBALES

table light; plastic, black
Tischleuchte; Kunststoff, schwarz
luminaire de table; plastique, noir

H 340, Ø 140, Base: Ø 140





97078

This luminaire has a colored light in the base.
 Diese Leuchte verfügt über ein farbiges Licht im Sockel.
 Cette luminaire a une lumière colorée dans la base.



97078



95695



97078 CABADO 1

table light; plastic, white
 Tischleuchte; Kunststoff, weiss
 luminaire de table; plastique, blanc

L 140, B 110, H 490, Base: B 130, T 105

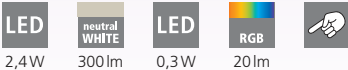

95695 CAJERO

table light; plastic, white
 Tischleuchte; Kunststoff, weiss
 luminaire de table; plastique, blanc

L 150, B 100, H 500, Base: B 155, T 100

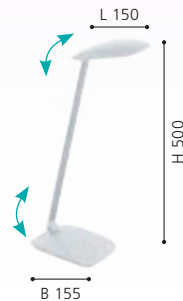

95696 CAJERO

table light; plastic, black
 Tischleuchte; Kunststoff, schwarz
 luminaire de table; plastique, noir

L 150, B 100, H 500, Base: B 155, T 100





95696

LED



95694

LED

95694 CAJERO

table light; plastic, silver
Tischleuchte; Kunststoff, silber
luminaire de table; plastique, argent

L 150, B 100, H 500, Base: B 155, T 100

LED

4,5W

neutral
WHITE

687 lm



9 002759 956943

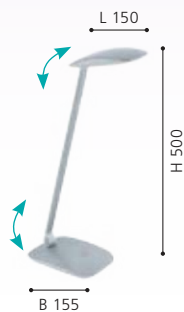



DESIGN
HIGHLIGHT
DETAIL



99019

99019 TABILLANO 1

table light; steel, black
Tischleuchte; Stahl, schwarz
luminaire de table; acier, noir

L 560, B 180, H 475, Base: Ø 180



E27 1x 40W



9 002759 990190



96957 TORONA 1

table light; steel, white / wood, natural
Tischleuchte; Stahl, weiss / Holz, natur
luminaire de table; acier, blanc / bois, nature

L 445, B 180, H 605, Base: Ø 180



E14 1x 28W



9 002759 969578





96957



94699



94702

94699 BORGILLIO

table light; steel, white
Tischleuchte; Stahl, weiss
luminaire de table; acier, blanc

94702 BORGILLIO

table light; steel, chrome
Tischleuchte; Stahl, chrom
luminaire de table; acier, chrome

94697 BORGILLIO

table light; steel, black
Tischleuchte; Stahl, schwarz
luminaire de table; acier, noir

L 400, B 190, H 710, Base: Ø 190



E27 1x 40W



9 002759 946999

L 400, B 190, H 710, Base: Ø 190



E27 1x 40W



9 002759 947026

L 400, B 190, H 710, Base: Ø 190

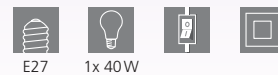

E27 1x 40W



9 002759 946975



94697



94704

94704 BORGILLIO

table light; steel, copper
Tischleuchte; Stahl, kupfer
luminaire de table; acier, cuivre

L 400, B 190, H 710, Base: Ø 190



E27



1x 40W



9 002759 947040

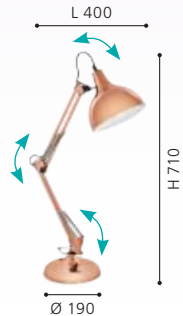



90967



90967 BANKER

table light; steel, brass / glass painted, green
Tischleuchte; Stahl, messing / Glas lackiert, grün
luminaire de table; acier, laiton / verre laqué, marron granit

L 275, H 390



E27



1x 60W



FIRMO

These luminaires come with a clip.

Diese Leuchten sind mit einer Klemme ausgestattet.

Ces luminaires viennent avec une pince fixation.



90872



90873



90874

90872 FIRMO

table light; steel, plastic, shiny white
Tischleuchte; Stahl, Kunststoff, weiss glänzend
luminaire de table; acier, plastique, blanc brillant

L 730



E27 1x 40W



9 002759 908720



90873 FIRMO

table light; steel, plastic, shiny black
Tischleuchte; Stahl, Kunststoff, schwarz glänzend
luminaire de table; acier, plastique, noir brillant

L 730



E27 1x 40W



9 002759 908737

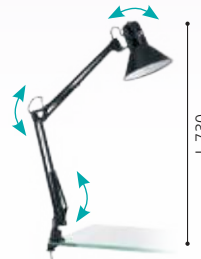

90874 FIRMO

table light; steel, plastic, silver
Tischleuchte; Stahl, Kunststoff, silber
luminaire de table; acier, plastique, argent

L 730

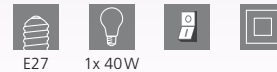

E27 1x 40W



9 002759 908744

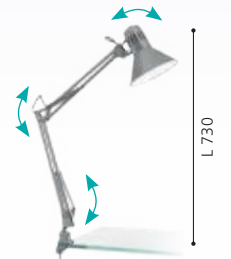



90977



9228



9229

90977 BASIC 1

table light; plastic, steel, silver
Tischleuchte; Kunststoff, Stahl, silber
luminaire de table; plastique, acier, argent

H 300, Base: Ø 125



E27 1x 40W



9 002759 909772



9228 BASIC

table light; plastic, steel, black
Tischleuchte; Kunststoff, Stahl, schwarz
luminaire de table; plastique, acier, noir

H 300, Base: Ø 125



E27 1x 40W



9 002759 922801



9229 BASIC

table light; plastic, steel, white
Tischleuchte; Kunststoff, Stahl, weiss
luminaire de table; plastique, acier, blanc

H 300, Base: Ø 125



E27 1x 40W



9 002759 922900





9230 BASIC

table light; plastic, steel, red
 Tischleuchte; Kunststoff, Stahl, rot
 luminaire de table; plastique, acier, rouge

H 300, Base: Ø 125



E27 1x 40W



9232 BASIC

table light; plastic, steel, blue
 Tischleuchte; Kunststoff, Stahl, blau
 luminaire de table; plastique, acier, bleu

H 300, Base: Ø 125

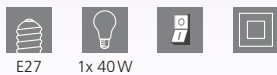

E27 1x 40W





DESIGN
HIGHLIGHT
DETAIL



92872

LED

92872 FOX

table light; steel, white, chrome
Tischleuchte; Stahl, weiss, chrom
luminaire de table; acier, blanc, chrome

H 320, Base: Ø 125

GU10 1x 2,8W 1x
 warm
 WHITE 250lm



9 002759 928728



92873 FOX

table light; steel, anthracite, chrome
Tischleuchte; Stahl, anthrazit, chrom
luminaire de table; acier, gris anthracite, chrome

H 320, Base: Ø 125

GU10 1x 2,8W 1x
 warm
 WHITE 250lm



9 002759 928735





92873

LED

CHILDREN LUMINAIRES

KINDERLEUCHTEN

LUMINAIRES POUR ENFANTS

PLAY OF COLOUR

The nursery luminaires are characterised by their playful and child-friendly designs. The lovely motives light up in many different colours and turn the nursery into a very special location.

FARBENSPIEL

Die Kinderzimmerleuchten zeichnen sich durch ihr verspieltes und kindgerechtes Design aus. Die liebevollen Motive erleuchten in unterschiedlichsten Farben und machen das Kinderzimmer zu einem besonderen Ort.



JEU DE COULEUR

Les éclairages de chambres d'enfants se distinguent de leur design joueur et adapté aux enfants. Les sujets formés avec amour sont illuminés dans des couleurs les plus variées et font de la chambre d'enfant un endroit spécial.





OVERVIEW

CHILDREN LUMINAIRES



TABARA
p. 836



JUNIOR 1
p. 836



RUFFO
p. 837

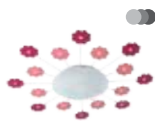

VIKI 1
p. 837



This product is available in different colors and shapes./ Dieser Artikel ist in unterschiedlichen Farben und Formen verfügbar.
Cet article est disponible en différentes couleurs et formes.



97667



87284

97667 TABARA

ceiling light; wood, steel, green, white / satin glass, design "soccer"

Deckenleuchte; Holz, Stahl, grün, weiss / Glas satiniert, Motiv Fussball

plafonnier; bois, acier, vert, blanc / verre satiné, motif «football»

H 80, Ø 400



E27



1x 60W



9 002759 976675



Ø 400

87284 JUNIOR 1

wall / ceiling light; steel, white / satin glass, design "soccer"

Wand- / Deckenleuchte; Stahl, weiss / Glas satiniert, Motiv Fussball

applique / plafonnier; acier, blanc / verre satiné, motif «football»

Ø 245



E27



1x 60W



9 002759 872847



Ø 245

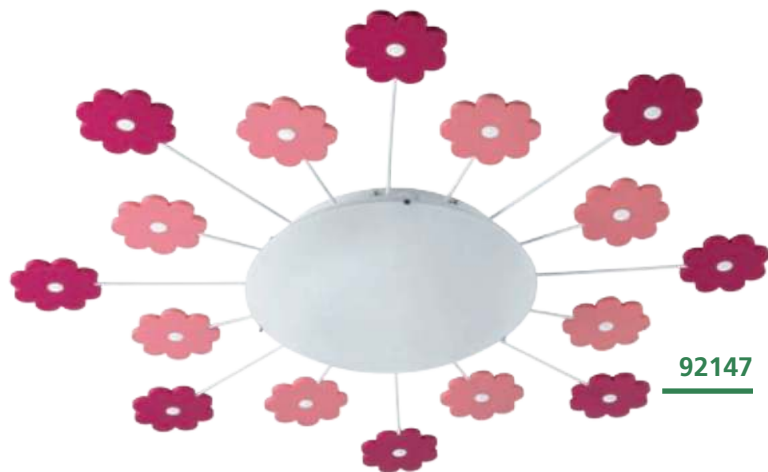

97575 RUFFO

ceiling light; steel, white / fabric, coloured
Deckenleuchte; Stahl, weiss / Textil, bunt
plafonnier; acier, blanc / tissu, coloré

H 110, Ø 380

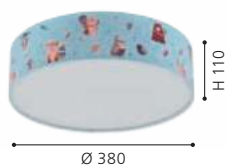

92146 VIKI 1

wall / ceiling light; steel, blue / satin glass, white
Wand- / Deckenleuchte; Stahl, blau / Glas satiniert, weiss
applique / plafonnier; acier, bleu / verre satiné, blanc

Ø 630, A 80

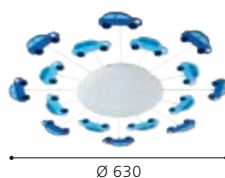

92147 VIKI 1

wall / ceiling light; steel, pink / satin glass, white
Wand- / Deckenleuchte; Stahl, pink / Glas satiniert, weiss
applique / plafonnier; acier, rose / verre satiné, blanc

Ø 615, A 80

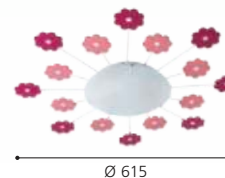

KITCHEN & FUNCTIONAL LUMINAIRES

KÜCHEN- & FUNKTIONSLEUCHTEN

LUMINAIRES FONCTIONNELS & DE CUISINE

YOUR KITCHEN FRIEND

Our kitchen and function luminaires ensure the right lighting for your workplace and become true supporters. The practical and perfect fitted luminaires ideally refine your kitchen area.

IHR KÜCHENFREUND

Unsere Küchen- und Funktionsleuchten sorgen für die richtige Beleuchtung Ihrer Arbeitsfläche und werden zur wahren Alltagshilfe. Die praktischen Unterbauleuchten sind die perfekte Ergänzung für Ihren Küchenbereich.



VOTRE AMI DE CUISINE

Nos lumières fonctionnelles et de cuisine assurent le bon éclairage de votre surface de travail et deviennent une aide parfaite dans le quotidien. Les éclairages de meuble sont l'accompagnement parfait de votre espace de cuisine.

OVERVIEW

KITCHEN & FUNCTIONAL LUMINAIRES



DUNDRY
p. 840-841



TEYA
p. 842



KOB LED
p. 843



BALIOLA
p. 843



This product is available in different colors and shapes./ Dieser Artikel ist in unterschiedlichen Farben und Formen verfügbar.
Cet article est disponible en différentes couleurs et formes.

DESIGN
HIGHLIGHT
DETAIL



97572 DUNDRY

wall / ceiling light; plastic, white / plastic, white
Wand- / Deckenleuchte; Kunststoff, weiss / Kunststoff, weiss
applique / plafonnier; plastique, blanc / plastique, blanc

L 570, B 25, H 35



97573 DUNDRY

wall / ceiling light; plastic, white / plastic, white
Wand- / Deckenleuchte; Kunststoff, weiss / Kunststoff, weiss
applique / plafonnier; plastique, blanc / plastique, blanc

L 870, B 25, H 35

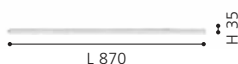

97574 DUNDRY

wall / ceiling light; plastic, white / plastic, white
Wand- / Deckenleuchte; Kunststoff, weiss / Kunststoff, weiss
applique / plafonnier; plastique, blanc / plastique, blanc

L 1170, B 25, H 35





97571

LED



97571 DUNDRY

wall / ceiling light; plastic, white / plastic, white
Wand- / Deckenleuchte; Kunststoff, weiss / Kunststoff, weiss
applique / plafonnier; plastique, blanc / plastique, blanc

L 310, B 25, H 35





96081



TEYA

Mounting type: incl. mounting clips
Switch type: sensor switch (on/off)

Befestigungsart: inkl. Montageclips
Schalterart: Sensor Schalter (ein/aus)

Type de fixation : clips de montage inclus
Type de interrupteur : interrupteur capteur (on/off)

96081 TEYA

under cabinet light; aluminium, silver / plastic, white
Unterbauleuchte; Alu, silber / Kunststoff, weiss
éclairage de meuble; aluminium, argent / plastique, blanc

L 600, B 55, H 25

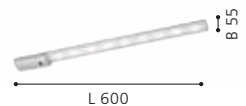



93707

LED

93706

LED



94686

LED



3 m

94686

Incl. battery: yes
 Inkl. sensor: yes
 Switch type: on/off/auto
 Mounting type: incl. adhesive tape
 Moveable LED: no

Inkl. Batterie: ja
 Inkl. Sensor: ja
 Schalterart: ein/aus/auto
 Befestigungsart: inkl. Klebeband
 Bewegliche LED: nein

Piles incluses : oui
 Capteur inclus : oui
 Type de interrupteur : marche/arrêt/auto
 Type de fixation : ruban adhésif inclus
 LED réglable : non



93707 KOB LED

under cabinet light; steel, satin nickel
 Unterbauleuchte; Stahl, nickel-matt
 éclairage de meuble; acier, nickel mat

L 600, B 70, H 25



3x 2,3W 780lm



9 002759 937072



93706 KOB LED

under cabinet light; steel, white
 Unterbauleuchte; Stahl, weiss
 éclairage de meuble; acier, blanc

L 600, B 70, H 25



3x 2,3W 780lm



9 002759 937065



94686 BALIOLA

wall light; plastic, silver
 Wandleuchte; Kunststoff, silber
 applique; plastique, argent

L 180, H 46, A 27

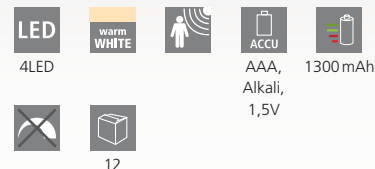

4LED

AAA, Alkali, 1,5V



12



9 002759 946869



ACCESSORIES

ZUBEHÖR
ACCESSOIRES

MAKING IT SPECIAL

Supplement your personal luminaire range with practical accessories and make your everyday life easier.

DAS GEWISSE EXTRA

Ergänzen Sie Ihr persönliches Leuchten-sortiment mit praktischem Zubehör und erleichtern Sie sich somit Ihren Alltag.



LE PETIT PLUS QUI COMPTE

Accompagnez votre collection personnelle de lumières par des accessoires pratiques et facilitez-vous ainsi votre quotidien.



92288

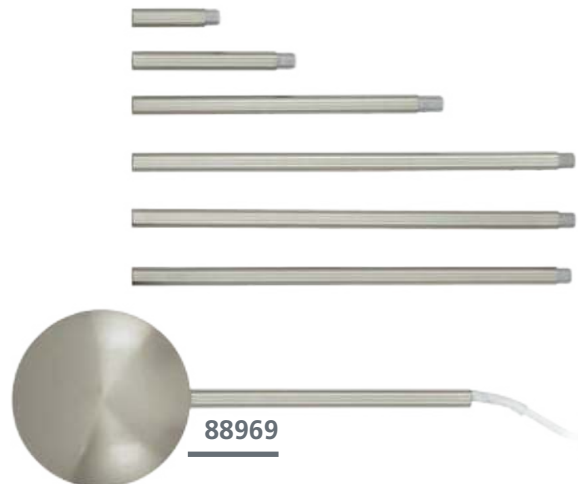

88969

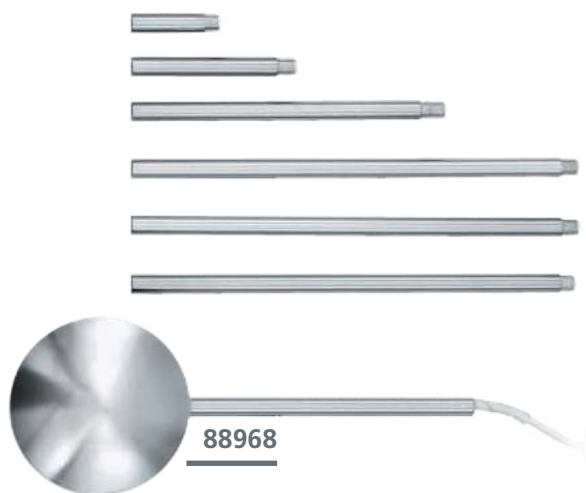

88968



88968, 88969, 92288

Can be extended or shortened from 320 to 1570 mm by screwing in/off the single pieces.

Der Kabelkanal kann durch Ein-/Ausdrehen der Einzelstücke von 320 bis 1570 mm verlängert bzw. verkürzt werden.

Le conduit de câble peut être prolongé ou raccourci en visse/dévisse les pièces uniques de 320 à 1570 mm.

92288 EXTENTION

accessory; steel, white
Zubehör; Stahl, weiss
accessoire; acier, blanc

L 1570, B 120

88969 EXTENTION

accessory; steel, satin nickel
Zubehör; Stahl, nickel-matt
accessoire; acier, nickel mat

L 1570, B 120

88968 EXTENTION

accessory; steel, chrome
Zubehör; Stahl, chrom
accessoire; acier, chrome

L 1570, B 120

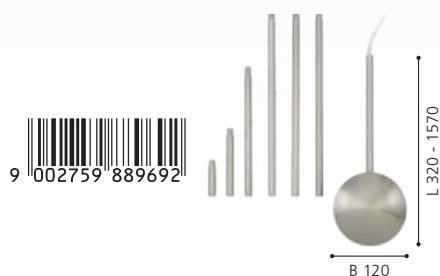



RUEDA

Turns your single-light luminaire into a three-light one for brighter lighting!

Verwandelt Ihre einflammige Leuchte in eine dreiflammige Lichtquelle für hellere Beleuchtung!

Il transforme votre luminaire à une lumière en une source lumineuse à trois lumières pour un éclairage plus clair!



92348



98277



98279

92348

accessory; plastic, white
Zubehör; Kunststoff, weiss
accessoire; plastique, blanc

L 113, B 44, H 28



10



9 002759 923488



B 44

98277 RUEDA

accessory; plastic, white
Zubehör; Kunststoff, weiss
accessoire; plastique, blanc

H 75, Ø 190



E27

3x 20W



9 002759 982775



Ø 190

98279 RUEDA

accessory; plastic, black
Zubehör; Kunststoff, schwarz
accessoire; plastique, noir

H 75, Ø 190



E27

3x 20W



9 002759 982799



Ø 190

3

1

2

98277



GLASS ASSORTMENT

GLAS SORTIMENT
SORTIMENT DE VERRES

SPECIAL GLASS

on this page we would like to give you a detailed view on an assortment of glasses that are used with our luminaires.

SPEZIAL GLAS

Auf diesen Seiten möchten wir Ihnen einen detaillierten Blick auf ausgesuchte Gläser geben, welche wir für unsere Produkte verwenden.



VERRES SPECIAL

Sur cette page nous voulons vous donner un aperçu détaillé des verres choisis que nous utilisons pour notre produits.



GLASS MATERIALS

GLAS-MATERIALIEN
MATÉRIAUX DE VERRE



glass alabaster, white
Glas alabaster, weiß
verre albâtre, blanc

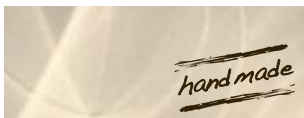

glass alabaster, champagne
Glas alabaster, champagner
verre albâtre, champagne



coating, black
Beschichtung, schwarz
revêtement, noir



glass wipe technique, champagner
Glas Wischtechnik, champagner
verre technique à l'essuyés, champagner

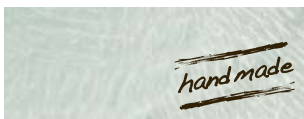

limed glass
Glas gekalkt
verre chaulé



brilliant glass
Brillantglas
verre brillant

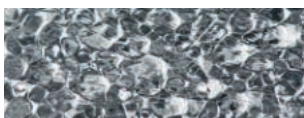

structured glass
Glas mit Struktur
verre structuré blanc



molten splinters of glass/ brilliant glass (granille)
geschmolzene Splitter von Glas / Brillantglas (granille)
éclats fondus de verre / verre brillant (granille)



structured glass, white printed decor
strukturiertes Glas, weiß gedrucktes Dekor
verre structuré, décor imprimé blanc



printed glass with decor
bedrucktes Glas mit Dekor
verre imprimé avec la décoration



glass painted, green
Glas lackiert, grün
verre laqué, vert



smoked glass, black-transparent
Rauchglas, schwarz-transparent
verre fumé, noir transparent



glass vaporized, black-transparent
Glas bedampft, schwarz-transparent
verre vaporisé, noir transparent



glass vaporized, amber
Glas bedampft, amber
verre vaporisé, ambre



gold-color
goldfarben
or



black-brown-transparent
schwarz-braun-transparent
noir-marron-transparent



black-grey-transparent
schwarz-grau-transparent
noir-gris-transparent

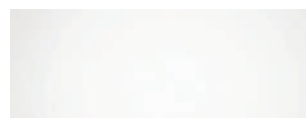

glass opal-matt
glas opal-matt
verre opale-mat



grey-matt
grau-matt
gris mat

EGLO WORLDWIDE

EGLO WELTWEIT

EGLO DANS LE MONDE



AUSTRIA

EGLO LEUCHTEN GMBH

Heiligkreuz 22
6136 Pill
T: +43 5242 6996 0 | F: +43 5242 6996 972
info-austria@eglo.com



AUSTRALIA

EGLO LIGHTING AUSTRALIA

5/339 Archerfield Road
4077 Richlands | Queensland
T: +61 7 3375 1413 | F: +61 7 3375 1412
info@eglolighting.com.au



BELGIUM

EGLO BELGIUM BV

Antwerpsesteenweg 247
2950 Kapellen
T: +32 3 250 60 80 | F: +32 3 219 80 67
info-belgium@eglo.com



BOSNIA AND HERZEGOVINA

EGLO RASVJETA BH D.O.O.

Ormanica bb
76250 Gradacac
T: +387 35 86 85 00 | F: +387 35 82 44 41
info-Bosnia-Herzegovina@eglo.com



BULGARIA

EGLO BULGARIA EOOD

Main Road Burgas-Sofia | 5th kilometer | Building EGLO
8000 Burgas
T: +359 56 960 403 | F: +359 56 53 05 95
info-bulgaria@eglo.com



CANADA

EGLO CANADA INC.

20700 Route Transcanadienne
H9X 4B7 Baie D'Ufré, Quebec
T: +1 514 457 5483 | F: +1 514 457 5487
info-canada@eglo.com



CHILE

EGLO CHILE ILUMINACIÓN LTDA.

Av. Américo Vespucio Norte 1930
Conchali - Santiago de Chile
T: +562 2 595 2222
info-chile@eglo.com



CHINA

DONGGUAN EGLO LIGHTING COMMERCIAL
CO LTD

No.1 | Shangqiao Industrial Rd Shangqiao, Dongcheng
Dongguancity, Guanzhouprovince
T: +86 769 2203 3866 | F: +86 769 2203 6866
info-china@eglo.com



COLOMBIA

EGLO COLOMBIA ILUMINACIÓN SAS

Autopista Norte 800 Mts adelante del Peaje de los Andes
Costado Oriental Km 19 Lote 30
Bogotá - Chia
T: +57 (1) 744 2339
info-global@eglo.com



COSTA RICA

EGLO COSTA RICA

Centro Comercial Calle Real local #8
Guachipilin de Escazú de la sucursal del BAC
San Jose 800 metros al norte | San Jose
T: +506-2289-4690 | F: +506-2100-6384
info-costarica@eglo.com



CROATIA

EGLO RASVJETA D.O.O.

Jadranska avenija 9a
10000 Zagreb
T: +385 1 379 40 62 | F: +385 1 379 41 04
info-croatia@eglo.com



CZECH REPUBLIC

EGLO CZ+SK s.r.o.

Náchodská 2479/63
193 00 Praha 9 Horní Pocernice
T: +420 281 924 163 | F: +420 281 925 205
info-czechrepublic@eglo.com



DENMARK

EGLO DANMARK A/S

Agerbakken 20
8362 Hørning
T: +45 70 22 55 11 | F: +45 70 22 55 221
info-denmark@eglo.com



ESTONIA

MOODNE VALGUSTUS AS

Rävalapst. 7
10143 Tallinn
T: +372 667 6670 | F: +372 631 3195
info-global@eglo.com



FINLAND

EGLO FINLAND OY

Malmniraitti 17A
700 Helsinki
T: +358 20 7649 820 | F: +358 20 7649 821
info-finland@eglo.com



FRANCE

EGLO FRANCE LUMINAIRE SARL

Z.A. Jeune Bois | 2 Rue de la Martinique
68274 Wittenheim
T: +33 3 89 62 50 45 | F: +33 389 6250 49
info-france@eglo.com



GERMANY

EGLO LEUCHTEN HANDELS GMBH

Kleinbahnstr. 35
59759 Arnsberg
T: +49 2932 6269 0 | F: +49 2932 6269 39
info-germany@eglo.com



GREAT BRITAIN AND IRELAND

EGLO UK LTD.

Unit 12 Cirrus Park, Lower Farm Road, Moulton Park
Industrial Estate, Northampton NN3 6UR
T: +44 1604 790 986 | F: +44 1604 670 282
info-greatbritain@eglo.com

**GREECE**
EGLO HELLAS A.E.

Sykias 2 and parodos dekeleias
13679 Acharnai
T: +30 21 0800 2363 | F: +30 210 240 07 29
info-greece@eglo.com

**HUNGARY - PRODUCTION AND LOGISTICS**
EGLO MAGYARORSZAG KFT.

Fő út, 155
3060 Paszto
T: + 36 32 560 050 | F: +36 32 560 040
info-hungary@eglo.com

**INDIA**
EGLO INDIA PRIVATE LIMITED

A-307, Ansal Chambers - 1, 3, Bhikaji Cama Place,
110066 Delhi
T: +91 85279 44288
info-india@eglo.com

**ITALY**
EGLO ITALIANA S.R.L.

Via Giotto, 4
31021 Mogliano Veneto (TV)
T: +39 041 45 66 232 / -245/ -251 |
F: +39 041 45 74 066 / -071
info-italy@eglo.com

**KAZAKHSTAN**
EGLO KAZAKHSTAN LLP

Al-Farabi Avenue 7, Office 72, 14rd floor, Block 4A,
Nurly-Tau Business Center
50059 Almaty
T: +7 727 293 25 20 | M: +7 701 031 00 00
info-kazakhstan@eglo.com

**KOSOVO**
EGLO KOSOVA LLC

Lugisht e qytetit pn
20000 Prizren
T: +383 44 216 687 | SHOP: +383 49 699 100
info-kosovo@eglo.com

**LATVIA**
MOODNE VALGUSTUS AS

Rävalapst.7
10143 Tallinn
T: +370 652 49923 | T: +372 667 6670
info-latvia@eglo.com

**LITHUANIA**
MOODNE VALGUSTUS AS

Rävalapst.7
10143 Tallinn
T: +370 652 49923 | T: +372 667 6671
info-latvia@eglo.com

**MAGYARORSZÁG – ÉRTÉKESÍTÉS**
EGLO LUX KFT.

Fő út, 143/A
2120 Dunakeszi
T: +36 27 341 353 | F: +36 27 341 409
info-hungary@eglo.com

**MALAYSIA**
EGLO ASIA SDN BHD

No. 13, Jalan Pelukis U1/46B, Temasya 18, Glenmarie,
40150 Shah Alam, Selangor Darul Ehsan
T: +6011 1050 2336 | F: +603 5567 9415
info-malaysia@eglo.com

**MEXICO**
EGLO MÉXICO ILUMINACIÓN S DE RL DE CV

Prolongación Avenida López Mateos Sur N°3561,
Fraccionamiento Los Gavilanes
C.P. 45645 Tlajomulco de Zúñiga | Jalisco
T: +52 33 3687 20 95
info-mexico@eglo.com

**MIDDLE EAST**
EGLO LIGHTING MIDDLE EAST FZE

P.O. BOX 262073, LOB6, OFFICE G18
Jebel Ali, Dubai, UAE
T: +97 148810080 | F: +97 148810081
gulf@eglo.com

**MOROCCO - EGLO AFRICA**
EGLO MAGHREB LUMINAIRES SARL

219 Bd Med Zerktonni. Suite: 67
20330 Casablanca
T: +212 522 98 80 25 / -05
info-global@eglo.com | info.africa@eglo.com

**THE NETHERLANDS**
EGLO VERLICHTING NEDERLAND B.V.

Innovatiepark 20
4906 AA Oosterhout (NBR)
T: +31 162 48 28 30
info.netherlands@eglo.com

**NORWAY**
MS Belysning AS

Heiaveien 4
1900 Fetsund
T: +47 63 888500 | F: +47 63 888501
info-norway@eglo.com

**PERU**
EGLO PERU S.A.C

Av Primavera 1419
Distrito de Santiago de Surco y Departamento de Lima
T: +51 902 763 635
info-peru@eglo.com

**POLAND**
EGLO POLSKA SP. Z O.O.

Ul. Dźwiękowa 2
02-857 Warszawa
T: +48 22 644 57 55 | F: +48 22 644 89 82
info-poland@eglo.com

**PORTUGAL**
EGLO PORTUGAL ILUMINAÇÃO, LDA

Rua Fonte Parada, 125
4595-434 Serroa-Paços de Ferreira
T: +351 255 890 000 | F: +351 255 892 346
info-portugal@eglo.com

**ROMANIA**
EGLO ROMANIA PRODEXIM SRL.

Str. Atomistilor nr. 1D
77125 Magurele - Ilfov
T: +40 314 250 902 | F: +40 314 250 899
info-romania@eglo.com

**RUSSIA**
EGLO LIGHTING LLC

Varshavskoe shosse 3 | Office 23
117105 Moscow
T: +7495 789 4311 | F: +7495 789 4312
info-russia@eglo.com

**SERBIA**
EGLO RASVETA DOO

Stefana Prvovenčanog 28
11000 Beograd
T: +381 11 3981 366 | F: +381 11 3981 389
info-serbia@eglo.com

**SLOVAKIA**
EGLO CZ+SK s.r.o

Náchodská 2479/63
193 00 Praha 9 Horní Pocernice
T: +421 313 211 551 | F: +421 313 211 556
info-slovakia@eglo.com

**SLOVENIA**
EGLO RASVJETA D.O.O.

Jadranska avenija 9a
10000 Zagreb
T: +386 158 093 18
info-slovenia@eglo.com

**SPAIN**
EGLO ESPANA ILUMINACION S.L.

Avda. de Castilla 1 (Edf. Best Point) 2º -16A
28830 San Fernando de Henares, Madrid
T: +34 91 677 9044 | F: +34 91 677 0304
info-spain@eglo.com

**SWEDEN**
EGLO SVERIGE AB

Star Street 1
512 50 Svenljunga
T: +46 340 623 505 | F: +46 340 623 605
info-sweden@eglo.com

**SWITZERLAND**
EGLO SCHWEIZ AG

Seetalstraße 142
6032 Emmen
T: +41 41 268 69 59 | F: +41 41 268 69 58
info-switzerland@eglo.com

**TURKEY**
EGLO Aydınlatma ithalat ihracat Ltd. Şti.

Eyüp Sultan Mah. Sekmen Cad. No:18/2
34855 Sancaktepe / Istanbul Samandıra
T: +90 216 311 09 -02 / -03 / -04 |
F: +90 216 311 09 / -05
info-turkey@eglo.com

**UKRAINE**
EGLO UKRAINE LTD

Vatslava Gavela boulevard, 6/7-A,
03124 Kyiv
T: +38 044 463 98 41 | F: +38 044 468 84 67
info-ukraina@eglo.com

**USA**
EGLO USA, INC.

3640 Royal South Parkway
30349 Atlanta, Georgia
T: +1 404 477 5601 | F: +1 404 393 7053
info-usa@eglo.com

HOW TO READ

ERKLÄRUNG

COMMENT LIRE

BUTTONS
BUTTONS
BOUTONS

Forest Stewardship Council®



p.8-9

DIMENSIONS DIMENSIONEN DIMENSIONS

all dimensions in mm | alle Größen in mm | toutes dimensions en mm

L = length | Länge | longueur

B = width | Breite | largeur

H = height | Höhe | hauteur

Ø = diameter | Durchmesser | diamètre

A = projection length | Ausladung | amplitude

ET = installation depth | Einbautiefe | profondeur utile

Base = base dimensions | Sockelmaße | dimensions de base

Attention! The dimensions relate solely to the sizes of the luminaire.
Any air spaces that would be relevant for a safe operating of the lamp were not considered.

Achtung! Die Größen beziehen sich nur auf die Abmessungen der Leuchte. Etwaige Lufträume, die für einen sicheren Betrieb der Leuchte notwendig sind, werden nicht berücksichtigt.

Attention! Les dimensions se réfèrent à la taille de la lampe seulement. Espacements éventuels, que seraient importants pour une opération de la lampe sans danger, n'ont pas été considérés.

BUTTONS BUTTONS BOUTONS

Colour Rendering Index | Farbwiedergabeindex | Indice de rendu de couleur de LED

CRI
>90

p.557

Bulb included | Leuchtmittel inkludiert | ampoules inclus



Recessed Luminaire | Einbauleuchte | luminaire encastrable



Surface Luminaire | Aufbauleuchte | luminaire en saillie



SKETCHES SKIZZEN CROQUIS

The sketches state the most meaningful dimensions. If a product is adjustable by will, a turquoise arrow marks this function and only the maximum dimensions are indicated.

Die Bemaßung der Skizzen umfasst jeweils die aussagekräftigsten Größen. Bei verstellbaren Produkten kennzeichnet ein türkiser Pfeil diese Funktion und nur die maximalen Größen werden angegeben.

Les dimensions des croquis comprennent les plus représentatives. Si un produit est réglable au choix, une flèche turquoise affiche cette fonction et rien que les dimensions maximales sont indiquées.

99551 CASIBARE
pendant light; steel, black
Hängeleuchte; Stahl, schwarz
luminaire en suspension; acier, noir

H 1100, Ø 150

E27 1x 40W

9 002759 995515

Ø 150

99552 CASIBARE
pendant light; steel, black
Hängeleuchte; Stahl, schwarz
luminaire en suspension; acier, noir

L 850, B 150, H 1100

E27 3x 40W

9 002759 995522

L 850

99553 CASIBARE
pendant light; steel, black
Hängeleuchte; Stahl, schwarz
luminaire en suspension; acier, noir

H 1500, Ø 710

E27 5x 40W

9 002759 995539

Ø 710

LIGHTING FAMILIES / STANDARD
234

ARTICLE NUMBER
ARTIKELNUMMER
NUMÉRO D'ARTICLE

SERIES NAME
SERIENNAME
NOM DE LA SÉRIE

DESCRIPTION
BESCHREIBUNG
DESCRIPTION

The product description is composed as follows:
luminaire type; enclosure material, enclosure colour / glass or shade material, glass or shade colour
Die Produktbeschreibung setzt sich wie folgt zusammen:
Leuchtenart; Gehäusematerial, Gehäusefarbe / Schirm- bzw. Glasmaterial, Schirm- bzw. Glasfarbe
La description du produit est composée comme suit:
type de luminaire; matériel de boîtier, couleur de boîtier / matériel de verre ou abat-jour, couleur de verre ou abat-jour



99554



99555

99554 CASIBARE
table light; steel, black
Tischleuchte; Stahl, schwarz
luminaire de table; acier, noir

L 160, B 120, H 490, Base: Ø 155



E27 1x 28W



9 002759 995546



99555 CASIBARE
floor light; steel, black
Stehleuchte; Stahl, schwarz
lampadaire; acier, noir

L 350, B 120, H 1605, Base: Ø 250



E27 2x 28W



9 002759 995553



LIGHTING FAMILIES / STANDARD
235

PRODUCT / PRODUCT IN THE AMBIANCE
PRODUKT / PRODUKTE IM AMBIENTE
PRODUITS / PRODUITS DANS L'AMBIANCE

You can find the article number next to each product on the page and in the ambient pictures.

Sie finden die Artikelnummer jedes Produktes neben der Abbildung auf der Seite und auf unseren Ambientbildern.

Vous pouvez trouver le numéro d'article à la page et à côté de chaque produit dans les images de l'ambiance.

PICTOGRAMMES
PIKTOGRAMME
PICTOGRAMMES

Technical details are represented as pictogrammes. An overview over all pictograms can be found on the next pages.

Technische Details werden als Piktogramme dargestellt. Eine Übersicht über alle Piktogramme finden Sie auf den nächsten Seiten.

Les détails techniques sont représentés sous forme de pictogrammes. Vous trouverez un aperçu de tous les pictogrammes dans les pages suivantes.

ENERGY EFFICIENCY LABELS
ENERGIEEFFIZIENZ-LABEL
LABEL DE L'EFFICACITÉ ÉNERGÉTIQUE

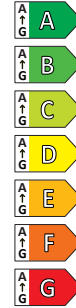
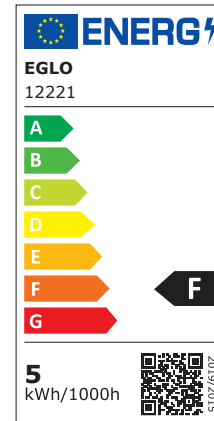

The new energy label must be indicated on all light sources with a luminous flux between 60 and 82,000 lumens and OLED. This applies to lamps, LED modules and luminaires where the light source cannot be removed without destroying it.

Das neue Energielabel muss auf allen Lichtquellen mit einem Lichtstrom zwischen 60 und 82.000 Lumen und OLED angegeben werden. Dies gilt für Lampen, LED-Module und Leuchten, bei denen die Lichtquelle nicht zerstörungsfrei entnommen werden kann.

Le nouveau label énergétique doit être indiqué sur toutes les sources lumineuses dont le flux lumineux est compris entre 60 et 82 000 lumens et sur les OLED. Cela s'applique aux lampes, aux modules LED et aux luminaires dont la source lumineuse ne peut être retirée sans être détruite.



















The information on the label includes: / Die Angaben auf dem Etikett beinhalten: / Les informations figurant sur l'étiquette sont les suivantes :

- › Name/Trademark
Name/Warenzeichen
Nom/marque de commerce
- › Model / Modell / Modèle
- › Energy label scale A-G / Energielabel-Skala A-G /
Échelle d'étiquetage énergétique A-G
- › Energy consumption for 1,000 hours of use/
Energieverbrauch bei 1.000 Stunden Nutzung/
Consommation d'énergie pour 1 000 heures
d'utilisation
- › Energy efficiency class of the product/
Energieeffizienzklasse des Produkts/
Classe d'efficacité énergétique du produit
- › QR Code to EPREL (Product Database of the European
Product Registry for Energylabelling)/
QR Code zur EPREL (Produktdatenbank der European
Product Registry for Energylabelling)/
Code QR pour EPREL (base de données des produits
du registre européen des produits pour l'étiquetage
énergétique)
- › The energy spectrum ranges from G to A.
Das Energiespektrum reicht von G bis A.
Le spectre énergétique va de G à A.



















































PICTOGRAM

PIKTOGRAMME PICTOGRAMME

SOCKETS / FASSUNGEN / DOUILLES

 LED	 G4	 G53
 2G7	 G5	 GU5,3 / MR16
 2G11	 G9	 GU10
 2GX13	 G10Q	 GX53
 E14	 G13	 GY6,35
 E27	 G23	 R7s

BULBS / LEUCHTMITTEL / AMPOULES

 E14 / C35	 E27 / A60 Halogen	 E27 / E140 Filament
 E14 / C35f	 E27 / R63 Halogen	 E27 / PS160 Filament
 E14 / D45	 E27 / A60 LED	 E27 / T30 Filament
 E14 / C35f LED	 E27 / A60 Filament	 E27 / T32 Filament
 E14 / D45 Halogen	 E27 / A65 LED	 G4 / T9
 E14 / C35 Halogen	 E27 / A75 Filament	 G4 / LT9
 E14 / T22	 E27 / G45 LED	 G4 / LT14
 E14 / C35 Filament	 E27 / G45 Filament	 G9
 E14 / C37 Filament	 E27 / G80 Filament	 G9 LED
 E14 / C35f Filament	 E27 / G95	 GU10
 E14 / C37f Filament	 E27 / G95 Filament	 GU10 LED
 E14 / P45 LED	 E27 / G125	 GU10 SMD LED
 E14 / P45 Filament	 E27 / G95 LED	 GX53 / LF75
 E14 / P50	 E27 / G200 Filament	LED LED board / LED Platine / LED bord
 E14 / ST48 Filament	 E27 / R63 LED	 MR16
 E14 / ST64 Filament	 E27 / ST48 Filament	 MR16 LED
 E14 / T20 LED	 E27 / ST64 Filament	 R7s / 78mm
 E27 / A60	 E27 / B80 Filament	 R7s / 118mm
 E27 / G90	 E27 / BR150 Filament	 R7s / 78mm LED
 E27 / QR63	 E27 / DP165 Filament	 R7s / 118mm LED

LIGHT COLOUR & LUMEN / LICHTFARBE & LUMEN / COULEUR LUMINEUX & LUMEN

The colours of the LED are represented as pictogrammes (see below), their luminous flux directly beneath. The luminous flux is quoted in lumen and describes the amount of light generated by the LED. The higher the value, the brighter is the lamp. Lumens are LED boards and are the light measurement value in bulbs.

Die Farben der LED werden als Piktogramm (siehe unten) dargestellt, deren Lichtstrom direkt darunter. Der Lichtstrom wird in Lumen gemessen und gibt die erzeugte Lichtmenge der LED an. Je höher der Wert, desto heller das Produkt. Lichtstromangaben (Lumen) sind Platinen- bzw. Leuchtmittelwerte.

Les couleurs de LED ont représentés sous forme de pictogrammes, leur flux lumineux directement en dessous. L'unité de flux lumineux est le lumen et il mesure la quantité de lumière générée par les LED. Plus la valeur est élevée, plus la lampe est lumineuse. Les lumens sont l'unité de mesure de l'intensité lumineuse des ampoules et des panneaux led intégrés.

	RGB RGB RGB
	RGB + white RGB + weiß RGB + blanc
	RGB + warmwhite RGB + warmweiß RGB + blanc chaud
	RGB + coldwhite RGB + kaltweiß RGB + blanc froid

	RGB + neutralwhite RGB + neutralweiß RGB + blanc neutral
	RGB + tunable white RGB + tunable white RGB + tunable white
	tunable white tunable white tunable white
	warm white warmweiß blanc chaud

	cold white kaltweiß blanc froid
	neutral white neutralweiß blanc neutre

SWITCHES & SENSORES / SCHALTER & SENSOREN / INTERRUPTEUR & CAPTEURS

	incl. cable & plug inkl. Kabel & Stecker câble & connecteur inclus
	internal dimmer eingebauter Dimmer variateur intégré
	button switch Druckknopf interrupteur de pression
	function switch Funktionsschalter interrupteur fonction
	rocker switch Wippschalter interrupteur à bascule
	pedal dimmer Trittdimmer variateur à pied

	pedal switch Trittschalter interrupteur à pied
	cable switch Kabelschalter interrupteur à câble
	incl. cable & plug transformer inkl. Kabel & Stecktransformator câble & transformateur à prise
	remote control Fernbedienung télécommande
	Day & Night Sensor Tag & Nacht Sensor sensor jour & nuit
	sensor Sensor sensor

	swedish plug Stecker Schweden connecteur swede
	"Touch me" ON/OFF "Touch me" EIN/AUS "Touch me" ON/OFF
	"Touch me" ON/OFF & dimm "Touch me" EIN/AUS & Dimmen "Touch me" ON/OFF & graduable
	pull switch Zugschalter interrupteur à bascule
	Timer - automatic on/off Zeitschaltuhr - automatisches Ein- & Ausschalten minuterie - peut être éteint et allumé automatiquement

FUNKTIONS & COMFORT / FUNKTIONEN & KOMFORT / FONCTIONS & CONFORT

	incl. battery inkl. Akku incl. pile
	incl. battery inkl. Batterie incl. pile
	battery specifications Batteriespezifikationen spécifications des piles
	beam angle Ausstrahlwinkel angle de rayonnement
	corner mount possible Eckmontage möglich montage en coin possible
	Colour Rendering Index

	cutout (in mm) Ausschnitt (in mm) perçage du panneau (en mm)
	dimmmable with external dimmer dimmbar mit externen Dimmer graduable avec un gradateur externe
	not dimmable nicht dimmbar ne pas graduable
	Can be operated via control unit Bedienbar über Steuergerät Peut être commandé par une unité de contrôle
	replaceable LED austauschbare LED LED remplaçables
	loadable in kg belastbar in kg chargeable en kg

	packaging / delivery unit Verpackungs- / Liefereinheit unité d'emballage / de livraison
	shortable kürzbar réductible
	Voltage Volt Voltage
	Watt
	USB connection USB-Anschluss Connexion USB
	Qi-Charger

PROTECTION CLASS / SCHUTZKLASSE / CLASSE DE PROTECTION

The protection class indicates to what extent the lamp is protected against electric shock. All lamps in this catalogue are at least protected with the protection class 1 - a higher class is specified in the information box of the respective lamp.

Die Schutzklasse gibt an, inwiefern ein Produkt gegen einen elektrischen Schlag gesichert ist. Alle Leuchten in diesem Katalog sind mit mindestens Schutzklasse 1 gesichert, bei höheren Klassen wird das Symbol im Infokasten der Leuchte angegeben.

La classe de protection indique, dans quelle mesure la lampe est protégée contre les chocs électriques. Tous les lampes dans ce catalogue sont protégées au moins avec la classe 1 - une classe plus élevée est indiquée dans l'information de la lampe.

	protection class 1: protective earthing Schutzklasse 1: Schutzerdung classe de protection 1: prise de terre
--	---

	protection class 2: protective insulation Schutzklasse 2: Schutzisolierung classe de protection 2: double isolation ou renforcée
--	--

	protection class 3: protective low voltage Schutzklasse 3: Schutzkleinspannung classe de protection 3: très basse tension de sécurité
--	---

PROTECTION RATING / SCHUTZGRAD / INDICE DE PROTECTION

The protection rating ensures the operational safety of luminaires. The first number specifies the extent of the protection against the ingress of foreign bodies; the second number identifies the humidity protection grade. All luminaires in this catalogue are at least protected with the rating IP20 - a higher rating is specified in the information box of the luminaire.

Der Schutzgrad gewährleistet die Betriebssicherheit von Leuchten. Die erste Ziffer des IP Grades beschreibt den Schutzzumfang gegen das Eindringen von Fremdkörpern; die zweite Ziffer informiert über den Grad des Feuchtigkeitsschutzes. Alle Leuchten in diesem Katalog sind mit mindestens Schutzgrad IP20 gesichert, bei höheren Graden wird das Symbol im Infokasten der Leuchte angegeben.

L'indice de protection assure la sécurité opérationnelle des luminaires. Le premier chiffre indique à quel point la protection est efficace contre l'insertion de corps étrangers; le second chiffre indique quant à lui le degré de protection par rapport à l'humidité. Tous les luminaires dans ce catalogue sont protégés au moins avec l'indice IP20 - un indice plus élevé est indiqué dans l'information d'article.

	IP33		IP44
--	------	--	------

	IP54		IP65
--	------	--	------

	IP67
--	------

REGISTER

SERIES NAMES
SERIENNAMEN
NOME DE PRODUITS

NAME NAME NOM	PAGE SEITE PAGE	NAME NAME NOM	PAGE SEITE PAGE	NAME NAME NOM	PAGE SEITE PAGE
ABREOSA	232	ARENAZA	803	BELSIANA	476
ACCESS REMOTE	102	ARISCANI	342-343	BELSIANA 1	477
ACOLLA	497	BAJAZZARA	198-199	BENARIBA	525
ACOLLA 1	497	BALIOLA	843	BERREGAS	674
AGLIENTINA	189	BANDERALO	804	BILBANA	790
AGUILARES	332	BANDERILLAS	294-295	BIMEDA	710-713
ALAMEDILLA	294	BANKER	826	BITACHITO	383
ALBANY	445	BARBOTTO	768	BOCADELLA	378
ALBARACCIN	352-353	BARI 1	651	BOCADELLA 1	474
ALBARIZA	184	BARI-M	610	BOLIVIA	414
ALCUDIA	633	BARNHAM	706-707	BOLSANO	362
ALEANDRO 1	360	BARRANCAS	478	BORDONARA	472
ALESSANDRA	445	BASIC	828-829	BORGILLO	769,824-825
ALMEIDA	191	BASIC 1	828	BOYAL	224-227
ALMEIDA 1	190	BASILANO	322-323	BRENDA	440-442
ALMEIDA 2	186-187	BASILANO 1	320-321	BROLINI	809
ALMERA	561	BASURTU	490	BUCAMARANGA	164
ALMONTE	604	BATABANO	787	BUDENSEA	766
ALOBRASE	335-337,339	BATALLAS	664-665	BUENAVISTA	652
ALTAFLOR	456-458	BATISTA	335	BUENAVISTA 1	654
ALVEZ	447	BATISTA 3	361,785	BUENAVISTA 2	654-655
AMADORA	278	BATTISTONA	524	BUTRANO	399
AMEZAGA	788	BAYA	774	BUZZ-LED	734-739
AMEZOLA	600	BAYA LED	772-773	CABADO	752
AMONTILLADO	394,464	BAYMAN	279	CABADO 1	820
ANCHORENA-Z	22-23	BELESER	346,766	CABALES	818-819
ANDABAIA-Z	27	BELLARIVA	782	CABO	494
ARANZOLA	765	BELLARIVA 3	783	CABO 1	742

NAME NAME NOM	PAGE SEITE PAGE	NAME NAME NOM	PAGE SEITE PAGE	NAME NAME NOM	PAGE SEITE PAGE
CABUS	634-635	CAROVIGNO	682	CORTADERAS	384,765
CADAQUES	340	CARPENTO	324	CORTENOVA	374
CADAQUES 1	340	CARTAMA	371	COSSANO	205-207
CADEGAL	588-589	CARTIGNANO	568	COSSANO 2	208
CAGUANES	430	CASIBARE	234-235,678	COSWARTH	680
CAHUAMA	784	CASIBARE-QI	805	COTORRO	667
CAJERO	820-821	CASTELLATO	790	CREMELLA	236-237
CALAGRANO	541	CASTRALVO	432	CUMIOLE	382
CALAGRANO-Z	37	CAUPO	808	CURASAO	408
CALMANERA	410-411	CAYUCA	717	DAKAR 1	702-703
CALNOVA	635	CEPPINO	814	DAKAR 3	754
CAMACHO	222-223	CERASELLA	355	DAMASCO 1	793-794
CAMASCA	415	CHIETINO 1	780	DAMBERA	816
CAMASTRA	418	CIGLIE	567	DARNIUS	768
CAMBAITO	414	CIVITATE	569	DAVIDA	720-721
CAMBULOS	394	CLAVELLINA	288-289	DAVIDA 1	722-723
CAMINALES-Z	46	CLEMENTE	363,496	DESIERTO	797
CAMPANIA	562	CODRIALES	296-297	DUNDRY	840-841
CAMPILO	424	COGNOLI	810	DURELO	545
CANICOSA 2	504	COLTI	562	DURENGO	816
CANTALLOPS	419	COMPETA 1	527-528	ELGVERO	587
CANTERRAS	230-231	CONCESSA 1	182-183	ELIZONDO	582
CAPASSO	530	CONDRADA 1	494	ELLA	544
CAPASSO 1	518	CONESA	762	ENALURI	370
CAPASSO-Z	55	CONESSA	368-369	ENCINITOS	409,477
CARANACOA	292-293	CONNECT Z	21	ENEA	704-705
CARBONERAS	767	CONNECT-Z SENSOR	21	ERMUA	395,787
CARDILLIO 1	744-745,747	CONSACA	676	ERSEKA	250-251
CARDILLIO 2	746-747	CONTRISA	434	ERVIDEL	286-287
CARDITO	497	CORBERA	728	ESCANDIDOS	244-245
CARDITO 1	364	CORETTO	357	ESPARTAL	763
CARLTON 2	778	CORREDERA	398	ESTAZIONA	761

NAME NAME NOM	PAGE SEITE PAGE	NAME NAME NOM	PAGE SEITE PAGE	NAME NAME NOM	PAGE SEITE PAGE
ESTEPERRA	152,155,669	GERBERA 1	562	LAZOLO	442
ESTEVAU	401	GEXO	818	LEBALIO	333
EXTENTION	845	GIRON	506	LED CARPI	616-617
FABIO	752	GIRON-S	507	LED PALERMO	615
FALICETTO	582	GITA 2	638	LED STRIPE-Z	84-85
FARSALA	345	GOROSIBA	262-263	LEJIAS	300-301
FEDRA 2	365	GOROSIBA 1	262	LIBERTAD	218,220
FELONICHE	575	GRADOLI	380	LIBERTAD 1	219
FERENTINO	522-523	GRADOLI 1	381	LISCIANA	397
FILAGO	430,493	GRAFIK	556	LM_LED_E14	87
FIRMO	827	GUANAL	584	LM_LED_E27	86-97
FLORESTA	406	GURARE	571	LM_LED_GU10	87
FONDACHELLI	760	HAYES	583	LOBATIA	387
FOX	830	HERRORA-Z	60	LOBINERO-Z	26
FRADELO	500-502	IMPERIAL	560	LOCANDA	714
FRADELO 1	498-499	IPOSITTO	464	LOMALTAS-Z	48
FRAIOLI-Z	50-51	ISIDRO	290-291	LONCINO 1	359
FRANIA	508-509,512-513,610,612	JUAREZA-Z	49	LORD 2	444
FRANIA-A	106-107	JUNIOR 1	836	LORETO	491
FRANIA-S	510-511,514-515,611	KOB LED	843	LORETO 1	491
FUEVA 5	618-624,626	LA SECA	807	LOSALOMAS	413
FUEVA-A	112	LACEY-QI	805	LUBERIO	366
FUEVA-Z	68-79	LAGUNITAS	354	LUPPINERIA	539
GAETANO 1	436,438	LANCIANO	520-521	LURONE	246-247
GAFARES	462-463	LANCIANO 1	520-521	MACCACARI	574
GASCUERIA	582	LANCIANO-Z	54	MACCHIONE	481
GATUELA	391	LAROA	812-813	MAGITTA 1	554
GATUELA 1	390	LASANA	306	MAGNUM LED	741
GAZZOLA	416	LASANA 1	302,307	MAGNUM-LED	740-741
GEMILIANA	632	LASANA 2	302-303	MANALBA	781
GENOVESE-Z	33	LASANA 3	304-305	MANALBA 1	781
GEO	795	LAURITO	536	MANILVA 1	612

NAME NAME NOM	PAGE SEITE PAGE	NAME NAME NOM	PAGE SEITE PAGE	NAME NAME NOM	PAGE SEITE PAGE
MANIZALES	381	MIRTAZZA	400	OBREGON	425
MANTUNALLE	348,790	MOGANO	484-485	OILELLA	330-331
MANTUNALLE 1	347	MOGANO 1	438	OKINZURI	401
MANZANARES	252-253	MOGANO 2	487	OLIVAL 1	791
MARASALES	158,160	MONGODIO 1	586	ONEDA	764
MARBELLA	284-285	MONIROTE	457,459	ONO 2	573
MARGHERA-Z	44-45	MONTEBALDO	383,478	OPTICA	258-260
MARGITTA 1	551	MONTEFINO	372	PADROGIANO-Z	38-40
MARIEL	434,493	MONTEFIO	442	PADULARI	460
MARINELLO	467	MONTEFIO 1	366-367	PALBIETA	392
MARINELLO 1	466	MONTEMORELOS-Z	32-33	PALERMO 2	529
MARMORATA	473	MONTENOVO	505	PALMERA	650
MAROJALES	493	MORATICA-A	107	PALMITAL	608-609
MARONDA	191	MORDAZO	479	PALOMARO	128-129
MARS	553,558	MOSIANO	609	PALOMARO 1	128-129
MARS 1	552-553	MULEGES	407	PALOZZA	314-315
MARYVILLA	334,788	MURCIA	280-281	PALOZZA 1	312
MASERLO	166-167,172-174,176-181	MURMILLO	344	PANAGRIA	228-229
MASERLO 1	169-170	MURNIA	786	PANDELLA 1	644-647
MASERLO 2	166,174,177,180	MUSARA	475	PANDELLA 2	644,648
MASETA	404-405	MUSURITA	534-535	PARANDAY-Z	36-37
MASSERIE	802	NADINA	763	PARRAPOS-Z	34-35
MENTALURGIA	542	NARANJO	797	PASCAL 1	561
MESSINARO	476	NARICES	248-249	PASSA	578-581
MESTRE	560-561	NASTASIA	188	PASTERI	122-125,132-139,141-147,777
METRASS	590	NEMO	556	PASTERI SQUARE	126-127
METRASS 1	593	NEVADO	311	PASTORE	130
METRASS 2	591	NIEVES	533	PASTORE 1	130
MEZZANA	378	NIEVES 1	532	PASTORE 2	131
MINI 4	754-755	NOCITO	708-709	PEDREGAL 1	779
MIOGLIA 1	368	NOSINO	761	PENJAMO	540
MIRLAS	468	NUVANO	436-437	PERPIGO	392

NAME NAME NOM	PAGE SEITE PAGE	NAME NAME NOM	PAGE SEITE PAGE	NAME NAME NOM	PAGE SEITE PAGE
PESCAITO	534	ROMAO 3	121	SARRIA	724-727
PETTO 1	787	ROMAO-Z	30-31	SARRIONE	774
PICACHA	767	ROMAZZINA	238-241	SARSINA-A	108
PIEDRITAS	482	ROMENDO 1	628-629	SAVATARILA-Z	56-57
PINETTO	614-615	RONCADE	309,313	SAVOY	282-283
PINTO	272-273	RONCADE 1	308	SCALEA 1	554
PINTO GOLD	270-271	RONDO	254-256	SEGEZIA	416-417
PINTO NERO	268	RONDO 3	256	SELLANO	806
PINTO TEXTIL	266-267	ROTTELO	732-733	SELUCI	536-537
PINTO TEXTIL 1	264	ROVIRA	391	SELVINA	309-310,312
PLANET	546	ROVITO-Z	80-83	SELVINA 1	308
PLANET 1	546-549	RUEDA	846	SELVINO	350-351
POLLICA	672	RUFFO	837	SENDERO	210-211
POSADERRA	126	RUIDERA	517	SERAS	696-697,700-701
POZONDON	505	RUOTALE	397,460	SERAS 1	694-695
POZUETA	377	RUSTICARIA	199	SERAS 2	698-699
RAMON	419	SABINAR	426-427,429	SIBERIA	298-299
RAYA	554	SALICETO-Z	47	SIDERNO	630
RAZONI	402-403	SALITERAS-Z	57	SILENTINA	480-481
REDUCTA 2	543	SALITRE	398	SILERAS	516-517
REKALDE	764	SALOBRENA-A	110-111	SILERAS-A	105
REMIDOS	589	SALOBRENA-Z	64-67	SILERAS-Z	55
RENDE	531	SALOME	558-559	SILVARES	388
RICCIO 1	753	SALTO	748-749	SIMOLARIS-Z	42-43
RIVATO	276-277	SALVILANAS-Z	24-25	SLIM	793
ROCAMAR	356,358	SAMBATELLO	684-685,687	SNAPORA	816
ROCAMAR 1	357-358	SAN PERI	564	SOLO	793
ROCCAFORTE	420-423	SAN PERI 1	601	SOLO 1	792
ROLIMARE	461	SANIA 4	576-577	SOLO 2	791
ROMAGNESE	360	SANIA 5	630-631	SOREGO	718
ROMAO	120-121	SARGINTO	594-595	SORRENTA 1	503
ROMAO 1	120	SARONA	386,788	SPADAFORA	394,464

NAME NAME NOM	PAGE SEITE PAGE	NAME NAME NOM	PAGE SEITE PAGE	NAME NAME NOM	PAGE SEITE PAGE
STAITI	479	TRAGACETE 1	636-637	VILLABATE	671
STAITI 1	564	TREMEDAL	475	VILLABATE 1	776-777
STELLATO 1	200-201	TRONDIO	783	VINCHIO	648
STELLATO 2	201-202	TROY 3	274-275	VINOVO	280
STELLATO 3	203	TRUNCA	802	VISERBELLA	148-150
STICKER	651	TUKON 3	730	VOLTAGO 2	518
SWARBY	785	TURCONA-Z	58,62-63	WASAO 1	609
TABARA	836	TURIALDO	216	ZAMPOTE	465
TABIANO	641	TURIALDO 1	785	ZAMUDILO	516
TABIANO-Z	49	ULISANO	460	ZAPATA	693
TABILLANO	688	UP 2	770-771	ZAPATA 1	690
TABILLANO 1	822	VADUMI	642	ZARAGOZA	162-163
TAMARA 1	602-603	VALBIANO	670	ZERACO	731
TAMURIA	470	VALCASOTTO	488,538	ZILLERIO-Z	26
TANURA	584	VALCASOTTO 1	489	ZINACUA	571
TARANDELL	307	VALDELAGRANO-Z	42	ZOCABON	406
TAREGA	389,783	VALDIOLA	412	ZOLA	650
TARRAFO	431,489	VALLASPRA	361	ZUBIALDE	572-573
TAZZOLI	567	VALLEMARE	503	ZUBIETA-A	102-104
TELIBELA-Z	28-29	VALMORA	310-311		
TEYA	842	VARILLAS	157		
TIMPAROSSA	570	VARRAZO	365		
TINDORI	204-205	VELASCO	196-197		
TINEO	753	VENEZUELA	242-243		
TIRRENARA	466	VERADAL	814-815		
TOLLOS-Z	30	VERADAL-QI	805		
TOLORICO	606	VERDELLO	632-633		
TORONA 1	822	VERGIANO	719		
TORRETTA	635	VETRO	446-447		
TORRONTES	340	VIGLIONI	431		
TOTARI-Z	33,52-53	VIKI 1	837		
TOWNSHEND 3	660-663	VILANOVA	742-743		

REGISTER

ARTICLE NUMBER
ARTIKELNUMMER
NUMÉROS D'ARTICLE

NUMBER NUMMER NUMÉRO	PAGE SEITE PAGE	NUMBER NUMMER NUMÉRO	PAGE SEITE PAGE	NUMBER NUMMER NUMÉRO	PAGE SEITE PAGE	NUMBER NUMMER NUMÉRO	PAGE SEITE PAGE	NUMBER NUMMER NUMÉRO	PAGE SEITE PAGE	NUMBER NUMMER NUMÉRO	PAGE SEITE PAGE
12221	92	12257	96	31581	132	31667	365	33682	616	81636	544
12222	92	12258	97	31582	136	31995	309	33941	588	81827	795
12223	92	3041	446	31586	136	31996	309	33942	589	81828	795
12224	93	30658	588	31588	143	31997	313	33964	589	82305	793
12225	93	30659	588	31589	132	32025	497	33984	262	82741	560
12226	88	30832	722	31592	136	32048	306	39092	322	82747	283
12227	88	30833	723	31594	145	32428	736	39093	323	82748	282
12228	88	30834	723	31595	135	32429	736	39094	323	82749	282
12229	89	30835	723	31596	139	32431	736	39095	322	82751	283
12231	89	30931	494	31599	173	32432	737	39099	320	82752	283
12232	89	30933	494	31601	166	32433	737	39101	320	82785	446
12233	90	31001	710	31602	177	32765	690	39102	321	82786	446
12234	90	31002	711	31603	179	32766	690	39103	320	82842	770
12235	90	31003	710	31605	173	32767	690	39113	324	82843	770
12236	91	31004	710	31606	166	33168	661	39114	324	82844	771
12237	91	31005	712	31607	176	33169	660	39836	294	82942	546
12239	91	31006	713	31608	180	33171	660	39838	294	83119	556
12241	94	31007	713	31611	172	33172	660	39839	295	83132	556
12242	94	31008	713	31613	177	33184	738	43637	485	83153	547
12243	94	31571	143	31614	179	33185	738	7184	558	83154	547
12244	95	31572	132	31616	172	33186	738	7186	558	83155	546
12245	95	31573	137	31618	176	33187	739	7188	559	83156	547
12251	87	31574	141	31619	179	33199	102	80263	553	83157	548
12252	87	31575	142	31627	174	33344	422	80264	553	83159	548
12253	86	31576	133	31628	167	33345	420	80265	558	83162	548
12254	87	31577	137	31629	178	3355	445	81262	752	83163	549
12255	96	31578	141	31631	180	33677	603	81265	752	83404	544
12256	96	31579	142	31666	441	33678	603	81635	544	83406	650

NUMBER NUMMER NUMÉRO	PAGE SEITE PAGE	NUMBER NUMMER NUMÉRO	PAGE SEITE PAGE	NUMBER NUMMER NUMÉRO	PAGE SEITE PAGE	NUMBER NUMMER NUMÉRO	PAGE SEITE PAGE	NUMBER NUMMER NUMÉRO	PAGE SEITE PAGE	NUMBER NUMMER NUMÉRO	PAGE SEITE PAGE
84028	556	87055	441	900022	57	900079	50	900128	55	900172	701
85104	792	87219	650	900023	57	900081	50	900129	55	900173	700
85261	254	87222	650	900024	57	900082	50	900134	765	900174	397
85262	254	87254	792	900025	56	900083	54	900135	765	900175	397
85263	255	87256	792	900044	64	900084	52	900141	791	900176	247
85264	255	87284	836	900045	64	900085	53	900142	791	900177	246
85832	651	87793	561	900046	64	900086	80	900143	414	900178	247
85856	284	88472	702	900047	65	900087	81	900144	162	900179	247
85857	284	88473	702	900048	65	900088	80	900145	162	900185	493
85858	285	88474	703	900049	66	900089	80	900146	162	900186	430
85859	284	88475	703	900051	66	900091	83	900147	163	900187	760
85971	774	88968	845	900052	66	900092	82	900148	163	900188	491
85974	774	88969	845	900053	67	900093	82	900149	530	900195	332
85977	274	89115	561	900054	58	900094	82	900151	196	900196	332
85978	274	89238	553	900055	58	900095	67	900152	196	900302	478
85979	274	89239	552	900056	58	900099	68	900153	196	900304	253
85981	275	89248	552	900057	62	900101	68	900154	197	900305	252
85982	275	89758	554	900058	62	900102	68	900157	491	900306	253
86712	560	89832	272	900059	62	900103	74	900158	415	900307	253
86715	561	89833	273	900061	63	900104	74	900159	415	900313	432
86811	258	89834	272	900062	63	900105	72	900161	426	900314	786
86812	258	89835	272	900067	44	900106	72	900162	426	900315	36
86813	260	89836	273	900068	44	900107	73	900163	426	900316	36
86814	260	900001	52	900069	44	900108	78	900164	236	900317	36
86815	260	900002	52	900071	45	900109	79	900165	242	900318	37
86816	258	900005	54	900072	45	900111	70	900166	242	900319	35
86817	259	900006	54	900075	42	900112	70	900167	242	900321	35
87008	444	900008	55	900076	51	900113	70	900168	243	900322	34
87009	444	900019	49	900077	51	900114	76	900169	700	900323	34
87054	442	900021	49	900078	51	900115	76	900171	700	900324	34

NUMBER NUMMER NUMÉRO	PAGE SEITE PAGE	NUMBER NUMMER NUMÉRO	PAGE SEITE PAGE	NUMBER NUMMER NUMÉRO	PAGE SEITE PAGE	NUMBER NUMMER NUMÉRO	PAGE SEITE PAGE	NUMBER NUMMER NUMÉRO	PAGE SEITE PAGE	NUMBER NUMMER NUMÉRO	PAGE SEITE PAGE
900325	573	900363	611	900404	27	900446	430	900495	238	900529	809
900328	465	900364	611	900406	30	900463	539	900496	240	900549	334
900329	465	900365	615	900407	30	900464	539	900497	241	900551	334
900331	718	900366	614	900408	32	900465	298	900498	532	900552	788
900332	718	900367	476	900409	32	900466	298	900499	532	900553	487
900333	718	900369	617	900411	32	900467	298	900501	532	900554	487
900334	785	900375	583	900412	33	900468	299	900502	198	900555	487
900335	530	900376	189	900419	461	900469	299	900503	198	900558	473
900336	28	900377	189	900421	462	900471	460	900504	198	900559	473
900337	28	900378	189	900422	463	900472	397	900505	199	900561	473
900338	28	900379	434	900423	463	900475	632	900506	335	900562	293
900339	29	900381	434	900424	463	900476	633	900507	335	900563	292
900341	264	900382	687	900425	414	900477	33	900508	335	900564	293
900342	264	900383	687	900426	414	900478	26	900509	481	900565	293
900343	584	900384	687	900428	601	900479	26	900511	256	900566	37
900346	416	900385	199	900429	412	90048	278	900512	256	900567	37
900347	188	900386	199	90043	554	900481	38	900513	746	900571	472
900348	188	900387	22	900431	412	900482	40	900514	747	900572	472
900349	219	900388	22	900432	667	900483	38	900515	747	900573	472
900351	288	900391	22	900433	667	900484	38	900516	746	900596	460
900352	288	900392	23	900434	667	900485	40	900517	584	900597	460
900353	288	900393	764	900435	489	900486	39	900518	584	900598	521
900354	289	900394	764	900436	717	900487	39	900519	238	900599	521
900355	482	900395	256	900437	717	900488	228	900521	241	900601	541
900356	482	900396	787	900438	717	900489	228	900522	239	900602	541
900357	482	900398	26	900439	30	90049	278	900523	241	900603	466
900358	790	900399	382	900441	31	900491	228	900524	479	900604	466
900359	484	900401	386	900442	31	900492	229	900525	570	900605	524
900361	493	900402	386	900443	489	900493	229	900526	570	900606	524
900362	434	900403	788	900444	431	900494	238	900528	809	900607	522

NUMBER NUMMER NUMÉRO	PAGE SEITE PAGE	NUMBER NUMMER NUMÉRO	PAGE SEITE PAGE	NUMBER NUMMER NUMÉRO	PAGE SEITE PAGE	NUMBER NUMMER NUMÉRO	PAGE SEITE PAGE	NUMBER NUMMER NUMÉRO	PAGE SEITE PAGE	NUMBER NUMMER NUMÉRO	PAGE SEITE PAGE
900608	522	90917	733	92288	845	93046	783	93877	772	94592	358
900609	523	90927	733	9229	828	93073	366	93901	806	94593	358
900611	523	90967	826	9230	829	93076	818	93917	770	94605	438
900612	531	90977	828	9232	829	93077	818	93949	129	94606	438
900613	531	90978	445	92348	846	93078	816	93952	129	94609	742
900614	491	90982	705	92563	279	93085	742	93965	808	94612	641
900615	632	90984	704	92595	734	93092	365	93966	808	94613	641
900616	632	90985	704	92596	734	93358	743	94145	730	94614	641
900617	633	90986	704	92597	734	93359	742	94146	730	94617	635
900618	633	91002	280	92598	735	93373	424	94244	371	94626	609
900619	611	91004	280	92599	735	93374	424	94245	371	94635	206
900626	805	91005	281	92641	740	93395	128	94251	714	94636	206
900628	805	91006	281	92642	740	93397	128	94252	714	94673	816
900631	296	91238	793	92643	740	93468	442	94319	360	94677	816
900632	296	91242	795	92644	741	93625	364	94329	753	94686	843
900633	297	91433	280	92645	741	93626	364	94377	359	94697	824
900634	164	91496	442	92727	494	93672	728	94378	359	94698	769
900635	164	91589	255	92739	276	93673	728	94388	403	94699	824
900636	33	91971	279	92741	277	93674	728	94389	403	94702	824
900839	747	92084	720	92742	277	93679	731	94438	205	94704	825
90304	268	92085	720	92743	277	93706	843	94442	205	94705	769
90305	268	92086	720	92761	362	93707	843	94513	787	94712	638
90697	562	92087	721	92762	362	93708	367	94547	484	94713	638
90737	562	92143	562	92872	830	93709	366	94548	484	94714	638
90872	827	92146	837	92873	830	93713	774	94584	707	94716	635
90873	827	92147	837	92924	754	93784	367	94585	706	94764	207
90874	827	92206	763	92925	754	93836	357	94586	706	94765	207
90914	732	92251	402	92933	755	93874	773	94587	706	94767	207
90915	732	92252	403	92935	754	93875	772	94589	356	94878	604
90916	732	9228	828	93003	273	93876	772	94591	356	94879	604

NUMBER NUMMER NUMÉRO	PAGE SEITE PAGE	NUMBER NUMMER NUMÉRO	PAGE SEITE PAGE	NUMBER NUMMER NUMÉRO	PAGE SEITE PAGE	NUMBER NUMMER NUMÉRO	PAGE SEITE PAGE	NUMBER NUMMER NUMÉRO	PAGE SEITE PAGE	NUMBER NUMMER NUMÉRO	PAGE SEITE PAGE
94884	609	95147	306	95483	708	95632	749	95912	369	96104	302
94918	143	95164	145	95484	709	95639	497	95913	368	96105	303
94919	134	95166	139	95485	708	95655	500	95914	369	96106	303
94921	137	95167	135	95522	388	95656	500	95972	518	96111	551
94924	144	95169	174	95523	388	95657	501	95973	518	96117	551
94925	134	95171	178	95525	389	95658	501	95993	602	96178	744
94926	138	95172	181	95526	389	95659	501	95994	602	96179	744
94935	436	95173	167	95527	783	95661	500	95995	602	96181	745
94936	436	95185	779	95539	760	95662	502	96023	530	96182	744
94938	438	95192	191	95541	760	95664	502	96026	518	96183	745
94958	725	95194	191	95545	693	95672	554	96032	528	96193	210
94959	725	95254	208	95546	693	95677	527	96033	528	96194	210
94961	725	95257	208	95547	693	95679	527	96034	528	96195	210
94962	724	95261	208	95567	307	95682	529	96037	590	96199	211
94963	726	95282	616	95568	307	95684	529	96038	590	96201	211
94964	726	95283	617	95569	302	95686	762	96039	593	96211	204
94965	727	95284	496	95589	203	95689	503	96041	593	96214	205
94966	726	95285	496	95591	203	95694	821	96042	591	96229	612
94967	616	95286	363	95594	203	95695	820	96043	591	96231	612
94973	545	95287	363	95597	201	95696	820	96048	573	96257	204
94987	651	95364	580	95598	200	95725	777	96049	573	96258	204
94995	191	95368	579	95599	200	95726	777	96064	646	96261	578
94998	615	95371	580	95602	200	95755	436	96065	646	96264	579
94999	615	95373	581	95605	202	95775	794	96066	646	96305	311
95044	146	95377	579	95606	201	95776	794	96072	447	96306	312
95045	146	95379	580	95607	201	95785	793	96073	447	96308	310
95055	178	95383	425	95609	202	95787	778	96081	842	96326	310
95118	144	95385	425	95628	749	95788	778	96089	551	96327	310
95119	139	95386	781	95629	748	95789	778	96102	302	96329	309
95122	135	95482	708	95631	749	95824	741	96103	303	96331	311

NUMBER NUMMER NUMÉRO	PAGE SEITE PAGE	NUMBER NUMMER NUMÉRO	PAGE SEITE PAGE	NUMBER NUMMER NUMÉRO	PAGE SEITE PAGE	NUMBER NUMMER NUMÉRO	PAGE SEITE PAGE	NUMBER NUMMER NUMÉRO	PAGE SEITE PAGE	NUMBER NUMMER NUMÉRO	PAGE SEITE PAGE
96332	311	96773	344	97367	372	97605	384	97718	630	97876	512
96343	345	96774	344	97368	372	97606	384	97719	630	97877	510
96344	345	96866	307	97479	130	97611	122	97731	478	97878	510
96345	345	96937	635	97487	503	97612	125	97733	383	97879	510
96434	812	96938	634	97506	719	97613	123	97734	383	97881	514
96435	813	96957	822	97507	719	97614	124	97737	521	97882	514
96436	813	96981	427	97508	719	97615	122	97738	520	97883	514
96437	812	96982	427	97516	780	97616	125	97773	782	97884	610
96438	812	96983	427	97526	506	97617	123	97774	782	97885	612
96439	813	96985	429	97527	506	97618	124	97777	120	97886	564
96474	447	96986	429	97528	506	97619	122	97778	121	97895	479
96477	144	97044	807	97531	610	97621	125	97779	120	97904	479
96478	134	97045	807	97536	670	97622	123	97782	120	97914	810
96479	138	97054	606	97537	670	97641	148	97783	121	97915	810
96481	141	97055	606	97538	670	97642	149	97784	121	97934	753
96483	147	97056	606	97541	507	97643	148	97793	361	97965	608
96484	147	97059	648	97542	507	97644	148	97806	765	97966	609
96528	360	97066	401	97543	507	97645	150	97838	130	98016	380
96538	128	97077	752	97571	841	97646	150	97839	270	98017	380
96539	129	97078	820	97572	840	97647	150	97841	420	98023	505
96541	628	97081	642	97573	840	97651	270	97845	420	98034	476
96542	628	97082	642	97574	840	97652	271	97846	421	98035	476
96543	629	97083	642	97575	837	97653	270	97854	423	98056	374
96544	628	97209	791	97577	516	97655	271	97855	423	98057	374
96552	696	97333	790	97578	517	97667	836	97857	423	98058	374
96553	697	97361	314	97583	768	97682	183	97871	508	98071	418
96554	697	97362	314	97584	768	97683	183	97872	508	98093	802
96555	697	97363	314	97587	361	97684	182	97873	508	98111	663
96566	567	97364	315	97589	785	97685	182	97874	512	98112	662
96567	567	97366	372	97604	384	97699	604	97875	512	98113	662

NUMBER NUMMER NUMÉRO	PAGE SEITE PAGE	NUMBER NUMMER NUMÉRO	PAGE SEITE PAGE	NUMBER NUMMER NUMÉRO	PAGE SEITE PAGE	NUMBER NUMMER NUMÉRO	PAGE SEITE PAGE	NUMBER NUMMER NUMÉRO	PAGE SEITE PAGE	NUMBER NUMMER NUMÉRO	PAGE SEITE PAGE
98114	662	98309	763	98409	130	98543	574	98651	342	98754	263
98134	684	98311	157	98421	576	98544	575	98652	342	98755	582
98135	684	98313	157	98422	576	98545	575	98653	343	98759	582
98136	685	98314	157	98423	576	98582	340	98654	343	98762	688
98137	684	98317	474	98424	577	98585	340	98656	586	98763	688
98139	671	98318	474	98425	577	98587	190	98657	586	98764	688
98141	671	98319	474	98426	577	98588	190	98661	377	98831	815
98201	111	98323	520	98446	509	98591	432	98662	377	98832	814
98203	111	98324	520	98447	513	98592	432	98663	377	98834	381
98205	110	98325	533	98448	511	98595	357	98674	764	98835	381
98206	110	98326	533	98449	515	98596	358	98676	587	98836	395
98207	108	98331	480	98456	419	98601	535	98677	645	98837	787
98208	108	98332	480	98458	768	98602	535	98678	370	98838	413
98209	108	98333	480	98487	505	98603	534	98679	475	98839	413
98212	112	98334	481	98488	505	98604	535	98682	392	98841	571
98219	107	98346	378	98491	464	98614	336	98683	392	98842	69
98227	105	98347	378	98492	394	98615	336	98685	504	98843	75
98228	105	98353	419	98494	464	98616	336	98687	391	98844	71
98235	107	98379	582	98495	394	98617	337	98688	401	98845	76
98236	106	98384	346	98501	648	98621	682	98689	401	98846	72
98237	106	98386	766	98502	648	98622	682	98694	350	98847	78
98247	802	98387	766	98507	475	98623	682	98695	350	98849	74
98263	567	98393	694	98514	493	98624	672	98696	350	98852	77
98277	846	98394	694	98523	352	98625	672	98697	351	98854	78
98279	846	98395	695	98524	352	98626	672	98698	351	98855	814
98291	340	98396	694	98525	353	98628	368	98699	351	98856	814
98292	112	98397	699	98526	352	98629	368	98734	440	98858	383
98293	112	98398	698	98527	504	98647	339	98735	440	98859	785
98294	106	98399	699	98541	574	98648	339	98752	263	98861	468
98297	110	98408	699	98542	574	98649	339	98753	263	98862	468

NUMBER NUMMER NUMÉRO	PAGE SEITE PAGE	NUMBER NUMMER NUMÉRO	PAGE SEITE PAGE	NUMBER NUMMER NUMÉRO	PAGE SEITE PAGE	NUMBER NUMMER NUMÉRO	PAGE SEITE PAGE	NUMBER NUMMER NUMÉRO	PAGE SEITE PAGE	NUMBER NUMMER NUMÉRO	PAGE SEITE PAGE
98863	468	99052	674	99113	766	99279	155	99339	637	99446	184
98864	788	99053	674	99122	600	99286	266	99341	516	99447	184
98874	286	99054	674	99123	600	99287	267	99342	516	99457	225
98875	286	99072	400	99124	600	99288	266	99343	525	99463	390
98876	286	99073	400	99202	618	99292	222	99344	525	99464	390
98877	287	99074	680	99203	618	99293	222	99345	236	99465	525
98878	287	99075	680	99204	621	99294	222	99346	236	99466	227
98881	477	99076	680	99205	620	99295	223	99347	237	99467	226
98882	477	99077	216	99206	618	99296	223	99348	564	99468	226
98887	794	99078	216	99207	619	99297	647	99353	225	99469	227
98888	590	99079	216	99208	620	99298	126	99356	497	99486	186
98889	312	99086	572	99209	620	99314	333	99358	296	99487	186
98891	104	99087	572	99211	623	99315	304	99366	348	99488	664
98892	104	99089	126	99212	622	99316	304	99367	348	99489	664
98893	104	99091	127	99213	622	99317	304	99368	348	99491	664
98894	102	99092	127	99214	622	99318	305	99369	790	99492	665
98895	102	99093	251	99249	398	99319	305	99371	347	99506	237
98896	103	99094	251	99265	624	99321	308	99372	347	99507	237
98907	644	99095	251	99266	624	99322	308	99395	461	99508	131
98908	644	99096	250	99267	624	99323	308	99397	542	99509	131
98909	378	99097	250	99268	626	99324	498	99398	542	99511	232
99013	392	99098	250	99269	626	99325	498	99399	543	99512	232
99015	761	99099	21	99271	626	99326	499	99406	534	99513	232
99019	822	99101	761	99272	152	99327	499	99407	534	99514	488
99041	170	99103	776	99273	152	99328	498	99408	225	99515	488
99042	169	99104	777	99274	152	99329	781	99413	224	99516	488
99043	169	99106	21	99275	155	99331	781	99429	294	99517	678
99044	169	99107	370	99276	669	99332	783	99438	416	99518	678
99045	170	99108	517	99277	669	99334	818	99439	417	99519	678
99046	170	99109	517	99278	669	99335	819	99445	184	99523	160

NUMBER NUMMER NUMÉRO	PAGE SEITE PAGE	NUMBER NUMMER NUMÉRO	PAGE SEITE PAGE	NUMBER NUMMER NUMÉRO	PAGE SEITE PAGE	NUMBER NUMMER NUMÉRO	PAGE SEITE PAGE	NUMBER NUMMER NUMÉRO	PAGE SEITE PAGE	NUMBER NUMMER NUMÉRO	PAGE SEITE PAGE
99524	158	99594	249	99631	262	99682	25	99774	652	99808	245
99525	158	99595	568	99632	262	99683	25	99776	636	99809	244
99526	160	99596	569	99633	405	99684	84	99777	636	99811	381
99527	160	99597	797	99634	404	99685	85	99778	636	99817	464
99531	387	99599	394	99635	404	99686	84	99779	536	99818	398
99532	387	99601	42	99636	404	99687	84	99781	537	99819	391
99539	174	99602	43	99639	60	99689	571	99782	536	99821	391
99541	177	99603	42	99651	354	99691	631	99783	536	99822	767
99542	180	99604	43	99654	354	99692	630	99784	458	99824	784
99543	166	99605	43	99655	470	99693	410	99785	458	99825	784
99544	230	99606	594	99656	470	99694	410	99786	458	99828	803
99545	230	99607	594	99659	467	99695	411	99787	457	99829	803
99546	231	99608	595	99661	408	99696	411	99788	456	99831	804
99547	231	99609	595	99662	408	99697	399	99789	457	99832	804
99548	60	99611	187	99663	437	99698	399	99791	459	99838	654
99549	60	99612	186	99664	477	99699	533	99792	457	99839	654
99551	234	99613	158	99665	409	99701	431	99793	466	99853	654
99552	234	99614	330	99666	409	99702	431	99794	797	99854	655
99553	234	99615	330	99667	490	99703	540	99795	218	99855	218
99554	235	99616	330	99669	47	99704	540	99796	220	99856	218
99555	235	99617	331	99671	47	99705	406	99797	220		
99559	312	99618	407	99672	47	99706	406	99798	220		
99561	291	99619	407	99673	46	99707	406	99799	300		
99562	290	99621	538	99674	46	99711	676	99801	300		
99563	291	99622	538	99675	46	99712	676	99802	300		
99564	291	99623	538	99676	48	99713	676	99803	301		
99588	49	99624	224	99677	48	99715	767	99804	301		
99591	249	99625	226	99678	24	99731	644	99805	301		
99592	248	99628	355	99679	24	99772	652	99806	244		
99593	249	99629	355	99681	24	99773	652	99807	244		



All previous catalogues and price lists are no longer valid with the issue of this catalogue. Errors, misprints, model and price changes and technical modifications are reserved. We deliver based on our terms of delivery and payment. Our products comply with the European light norm EN60598. Products with the ENEC test mark are conforming to the guide line 2006/95/EG. Products with additional safety remarks (e.g protection class, IP) are identified within the product family with the relevant symbol and number. The content of this catalogue is protected under copyright law for EGLO Leuchten GmbH. All rights reserved. Our specific written consent must be obtained before using any illustrations and texts. The pictures are 4C prints and may differ from the original. The product pictures and ambiances in this catalogue can deviate from reality, and they do not necessarily concur with the usual application of the product. EGLO does not assume liability for the correctness, completeness or the application depiction of the products and/or the product information. Design, layout and composition: EGLO GmbH, A-6136 Pill - AUSTRIA Print: Samson Druck GmbH, 5581 St. Margarethen - AUSTRIA Pictures: EGLO, Adobe Stock, istockphoto.com

Mit diesem Katalog verlieren alle vorhergehenden Kataloge und Preislisten ihre Gültigkeit. Irrtümer, Druckfehler, Modell- und Preisänderungen sowie technische Änderungen vorbehalten. Wir liefern zu unseren Liefer- und Zahlungsbedingungen. Unsere Produkte entsprechen der europäischen Leuchtnorm EN 60598. Produkte mit dem ENEC Prüfzeichen sind konform mit der Richtlinie 2006/95/EG. Produkte mit weiteren Sicherheitshinweisen (zB. Schutzklasse, IP) sind mit Symbol und Zahl bei der Produktfamilie ausgezeichnet. Der Inhalt dieses Kataloges ist für die EGLO Leuchten GmbH urheberrechtlich geschützt. Alle Rechte sind vorbehalten. Bilder und Texte dürfen nicht ohne vorherige ausdrückliche, schriftliche Genehmigung verwendet werden. Die Abbildungen sind 4C Drucke und können vom Original abweichen. Die Katalogbilder und die gezeigten Darstellungen der Produkte können von der Wirklichkeit abweichen und nicht den üblichen Produktanwendungen entsprechen. EGLO übernimmt keine Haftung für die Richtigkeit, Vollständigkeit und Anwendungsdarstellung der Produkte und Produktinformationen. Gestaltung, Layout und Satz: EGLO GmbH, A-6136 Pill - AUSTRIA Druck: Samson Druck GmbH, 5581 St. Margarethen - AUSTRIA Bilder: EGLO, Adobe Stock, istockphoto.com

Le présent catalogue remplace tous les catalogues et tarifs précédents. Sous réserve d'erreurs, de fautes d'impression, de modification des modèles et de changement de prix et de technique. Nous livrons sur la base de nos conditions de livraison et de paiement. Nos produits sont conformes aux normes européennes EN 60598 et portent le marquage CE. Les produits portant la marque ENEC sont conformes à la Directive 2006/95/EG. Les produits portant d'autres indications de sécurité (par exemple classe de protection, IP) sont identifiés par le symbole et le nombre correspondants dans la famille de produits. Le contenu du présent catalogue est protégé pour la société EGLO Leuchten GmbH par un copyright. Tous droits réservés. Toute reproduction d'images et du texte est interdite sans autorisation explicite par écrit préalable. Les images sont imprimées en 4C et peuvent différer de l'original. Les images des produits et les ambiances dans le catalogue peuvent dévier de la réalité et ne sont pas nécessairement en ligne avec l'usage habituel du produit. EGLO n'engage pas sa responsabilité sur la justesse des images et sur les informations relatives à l'usage pouvant être fait des produits. Conception, maquette et composition: EGLO GmbH, A-6136 Pill - AUSTRIA Presse: Samson Druck GmbH, 5581 St. Margarethen - AUSTRIA Images: EGLO, Adobe Stock, istockphoto.com

07-2022



EGLO
my light | my style

EGLO Leuchten GmbH
Heiligkreuz 22
A-6136 Pill
Austria
Tel. +43 (0) 5242 6996
Fax +43 (0) 5242 6996-972
info@eglo.com
www.eglo.com

KAT-22



my light | my style